

Huawei FusionServer Pro 2488H V5 Server V100R005

Technical White Paper

Issue 11
Date 2020-09-03



Copyright © Huawei Technologies Co., Ltd. 2020. All rights reserved.

No part of this document may be reproduced or transmitted in any form or by any means without prior written consent of Huawei Technologies Co., Ltd.

Trademarks and Permissions



HUAWEI and other Huawei trademarks are trademarks of Huawei Technologies Co., Ltd.

All other trademarks and trade names mentioned in this document are the property of their respective holders.

Notice

The purchased products, services and features are stipulated by the contract made between Huawei and the customer. All or part of the products, services and features described in this document may not be within the purchase scope or the usage scope. Unless otherwise specified in the contract, all statements, information, and recommendations in this document are provided "AS IS" without warranties, guarantees or representations of any kind, either express or implied.

The information in this document is subject to change without notice. Every effort has been made in the preparation of this document to ensure accuracy of the contents, but all statements, information, and recommendations in this document do not constitute a warranty of any kind, express or implied.

Huawei Technologies Co., Ltd.

Address: Huawei Industrial Base
Bantian, Longgang
Shenzhen 518129
People's Republic of China

Website: <https://e.huawei.com>

About This Document

Purpose

This document describes the 2488H V5 rack server in terms of features, structure, specifications, and component compatibility.





Intended Audience

This document is intended for:

- Huawei presales engineers
- Channel partner presales engineers
- Enterprise presales engineers

Symbol Conventions

The symbols that may be found in this document are defined as follows.

Symbol	Description
	Indicates a hazard with a high level of risk which, if not avoided, will result in death or serious injury.
	Indicates a hazard with a medium level of risk which, if not avoided, could result in death or serious injury.
	Indicates a hazard with a low level of risk which, if not avoided, could result in minor or moderate injury.
	Indicates a potentially hazardous situation which, if not avoided, could result in equipment damage, data loss, performance deterioration, or unanticipated results. NOTICE is used to address practices not related to personal injury.

Symbol	Description
 NOTE	Supplements the important information in the main text. NOTE is used to address information not related to personal injury, equipment damage, and environment deterioration.

Change History

Issue	Date	Description
11	2020-09-03	<ul style="list-style-type: none"> This issue is the eleventh official release.
10	2020-07-31	<ul style="list-style-type: none"> This issue is the tenth official release.
09	2020-06-05	<ul style="list-style-type: none"> This issue is the ninth official release.
08	2020-04-20	<ul style="list-style-type: none"> This issue is the eighth official release.
07	2019-11-15	<ul style="list-style-type: none"> This issue is the seventh official release.
06	2019-08-23	<ul style="list-style-type: none"> Added the support for Cascade Lake processors.
05	2018-11-30	<ul style="list-style-type: none"> This issue is the fifth official release.
04	2018-07-23	<ul style="list-style-type: none"> This issue is the fourth official release.
03	2018-05-08	<ul style="list-style-type: none"> This issue is the third official release.
02	2018-02-01	<ul style="list-style-type: none"> This issue is the second official release.
01	2017-12-20	<ul style="list-style-type: none"> This issue is the first official release.

Contents

About This Document.....	ii
1 Overview.....	1
2 Features.....	2
3 Physical Structure.....	5
4 Logical Structure.....	7
5 Hardware Description.....	9
5.1 Front Panel.....	9
5.1.1 Appearance.....	9
5.1.2 Indicators and Buttons.....	10
5.1.3 Ports.....	14
5.2 Rear Panel.....	16
5.2.1 Appearance.....	16
5.2.2 Indicators.....	17
5.2.3 Ports.....	19
5.3 Processor.....	22
5.4 Memory.....	22
5.4.1 Memory Identifier.....	22
5.4.2 Memory Subsystem Architecture.....	24
5.4.3 Memory Compatibility.....	25
5.4.4 Memory Installation Guidelines.....	27
5.4.5 Memory Installation Positions.....	28
5.4.6 Memory Protection Technologies.....	31
5.5 Storage.....	32
5.5.1 Drive Configurations.....	32
5.5.2 Drive Numbering.....	32
5.5.3 Drive Indicators.....	33
5.5.4 RAID Controller Card.....	34
5.6 I/O Expansion.....	35
5.6.1 PCIe Cards.....	35
5.6.2 PCIe Slots.....	35
5.6.3 PCIe Slot Description.....	35

5.7 PSUs.....	37
5.8 Fans.....	37
5.9 LCD.....	38
5.10 Boards.....	39
5.10.1 Mainboard.....	40
5.10.2 Daughter Board.....	41
5.10.3 Drive Backplane.....	43
6 Product Specifications.....	46
6.1 Technical Specifications.....	46
6.2 Environmental Specifications.....	51
6.3 Physical Specifications.....	53
7 Software and Hardware Compatibility.....	54
8 Safety Instructions.....	55
8.1 Safety Instructions.....	55
8.2 Maintenance and Warranty.....	58
9 System Management.....	59
10 Certifications.....	61
A Appendix.....	63
A.1 Product SN.....	63
A.2 Operating Temperature Limitations.....	64
A.3 Nameplate	66
A.4 RAS Features.....	66
A.5 Sensor List.....	69
B Glossary.....	75
B.1 A-E.....	75
B.2 F-J.....	76
B.3 K-O.....	76
B.4 P-T.....	76
B.5 U-Z.....	77
C Acronyms and Abbreviations.....	78
C.1 A-E.....	78
C.2 F-J.....	79
C.3 K-O.....	80
C.4 P-T.....	81
C.5 U-Z.....	83

1 Overview

Huawei FusionServer Pro 2488H V5 (2488H V5) is a new-generation 2U 4-socket rack server designed for Internet, Internet Data Center (IDC), cloud computing, enterprise, and telecom applications.

The 2488H V5 is ideal for applications such as databases, cloud computing, virtualization, and in-memory computing.

The secure, compact 2488H V5 is a highly expandable server delivering high-performance computing, large storage capacity and low power consumption. It is easy to deploy and manage and supports virtualization.

 **NOTE**

For details about the 2488H V5 nameplate information, see [A.3 Nameplate](#) .

Figure 1-1 2488H V5 (with 25 drives)



2 Features

Performance and Scalability

- Powered by Intel® Xeon® Scalable Skylake or Cascade Lake processors, the server provides up to 28 cores, 3.8 GHz frequency, a 38.5 MB L3 cache, and three 10.4 GT/s UPI links between the processors, which deliver supreme processing performance.
 - It supports four processors with 112 cores and 224 threads to maximize the concurrent execution of multithreaded applications.
 - The layered architecture of the processor cache is optimized. The L2 cache capacity is increased to process memory data directly, which greatly improves the memory access performance. Each core can exclusively use 1 MB of L2 cache, reducing the load on L3 cache. A single processor can share a maximum of 38.5 MB L3 cache.
 - Intel Turbo Boost Technology 2.0 allows processor cores to run faster than the frequency specified in the Thermal Design Power (TDP) configuration if they are operating below power, current, and temperature specification limits.
 - Intel Hyper-Threading Technology enables each processor core to run up to two threads, improving parallel computation capability.
 - The hardware-assisted Intel® Virtualization Technology (Intel® VT) allows operating system (OS) vendors to better use hardware to address virtualization workloads.
 - With Intel® Advanced Vector Extensions 512 (AVX-512), applications can pack 32 double-precision and 64 single-precision floating-point operations per second in a clock cycle within the 512-bit vectors, as well as eight 64-bit and sixteen 32-bit integers, with up to two 512-bit fused multiply-add (FMA) units. Compared with Intel® Advanced Vector Extensions 2.0 (Intel® AVX2), Intel® AVX-512 doubles the width and number of data registers and the width of FMA units.
 - The Cascade Lake processors support Intel® Deep Learning Boost vector neural network instructions (VNNI) to improve the performance of deep learning applications.
- The server supports double data rate 4 (DDR4) registered dual in-line memory modules (RDIMMs) and load-reduced DIMMs (LRDIMMs) with error checking and correcting (ECC). A server fully configured with forty-eight 2933

MT/s memory modules (only available with Cascade Lake processors) provides 6144 GB memory space and the maximum theoretical memory bandwidth of 549.9 GB/s.

- Flexible drive configurations cater to a variety of business requirements and ensure high elasticity and scalability of storage resources.
- The use of all solid-state drives (SSDs) is supported. An SSD supports up to 100 times more I/O operations per second (IOPS) than a typical hard disk drive (HDD). The use of all SSDs provides higher I/O performance than the use of all HDDs or a combination of HDDs and SSDs.
- The use of 12 Gbit/s SCSI (SAS) serial connection for internal storage provides 2x data transmission rate than the use of 6 Gbit/s SAS connection, maximizing the performance of I/O-intensive applications.
- With Intel integrated I/O, the Intel® Xeon® Scalable processors integrate the PCIe 3.0 controller to shortens I/O latency and improve overall system performance.
- The server supports up to 11 PCIe 3.0 slots.

Availability and Serviceability

- Carrier-class components with process expertise ensure high system reliability and availability.
- The server uses hot-swappable SAS/SATA/NVMe drives. It supports RAID 0, 1, 1E, 10, 5, 50, 6, and 60, depending on the RAID controller card used. It also uses a supercapacitor to protect the RAID cache data against power failures.
- The server provides simplified O&M and efficient troubleshooting through the UID/HLY indicators on the front panel, fault diagnosis LED, touch LCD diagnosis panel, and iBMC web interface.
- The SSDs offer better reliability than HDDs, ensuring continued system performance.
- The built-in iBMC monitors system parameters in real time, triggers alarms, and performs recovery actions to minimize the system downtime.
- Huawei provides a three-year warranty for parts replacement and onsite repair for the servers used in China. Huawei provides a 10-hour-a-day, 7-day-a-week support program. Service requests will be handled the next business day. Optional service upgrades are available.
- Huawei provides a three-year warranty for parts replacement and repair for the servers used outside China. Huawei provides a 9-hour-a-day, 5-day-a-week support program. Service requests will be handled the next business day. Huawei delivers the repaired or new parts within 45 calendar days after receiving the defective parts.

Manageability and Security

- The built-in iBMC monitors server operating status and provides remote management.
- A password is required for accessing the BIOS, ensuring system boot and management security.
- The Network Controller Sideband Interface (NC-SI) allows a network port to serve as a management port and a service port for maximized return on

investment (ROI) for customers. The NC-SI feature is disabled by default and can be enabled through the iBMC or BIOS.

- The integrated Unified Extensible Firmware Interface (UEFI) improves setup, configuration, and update efficiency and simplifies fault handling.
- Lockable server chassis panel ensures security of local data.
- Intel Execute Disable Bit (EDB) function prevents certain types of malicious buffer overflow attacks when working with a supported OS.
- Intel Trusted Execution Technology enhances security using hardware-based defense against malicious software attacks, allowing applications to run independently.
- The trusted platform module (TPM) and trusted cryptography module (TCM) provide advanced encryption functions, such as digital signatures and remote authentication.
- The following requirements in NIST SP 800-147B are met:
 - The BIOS firmware digital signature update mechanism is supported. During the upgrade, the digital signature is verified to prevent unauthorized BIOS firmware upgrade.
 - The flash security protection mechanism is supported to prevent unauthorized modification of the flash memory in the OS.

NOTE

The service port with NC-SI enabled supports the following configuration:

- Configuring any LOM port of the server as the service port with NC-SI enabled. Host port 1 is configured by default.
- Enabling, disabling, and setting a virtual local area network (VLAN) ID for this port. The VLAN ID is 0 and disabled by default.
- Configuring IPv4 addresses (IPv4 address, subnet mask, and gateway) and IPv6 addresses (IPv6 address, prefix length, and gateway) for this port.

Energy Efficiency

- The 80 Plus Platinum power supply units (PSUs) of multiple power ratings provide 94% power efficiency at 50% load.
- Efficient voltage regulator-down (VRD) power supplies for boards minimize the energy loss from DC/DC power conversion.
- Area-based, Proportional-Integral-Derivative (PID) intelligent fan speed adjustment and intelligent CPU frequency scaling optimize heat dissipation and reduce overall system power consumption.
- The improved thermal design with energy-efficient fans ensures optimal heat dissipation and reduces system power consumption.
- The server is protected with power capping and power control measures.
- Staggered spin-up for drives reduces the server boot power consumption.
- Intel® Intelligent Power Capability allows a processor to be powered on or off based on requirements.
- Low-voltage Intel® Xeon® Scalable processors consume less energy, ideally suited for data centers and telecommunications environments constrained by power and thermal limitations.
- SSDs consume 80% less power than HDDs.

3 Physical Structure

Figure 3-1 Physical structure of a 2488H V5 with 8 x 2.5" drives (example)

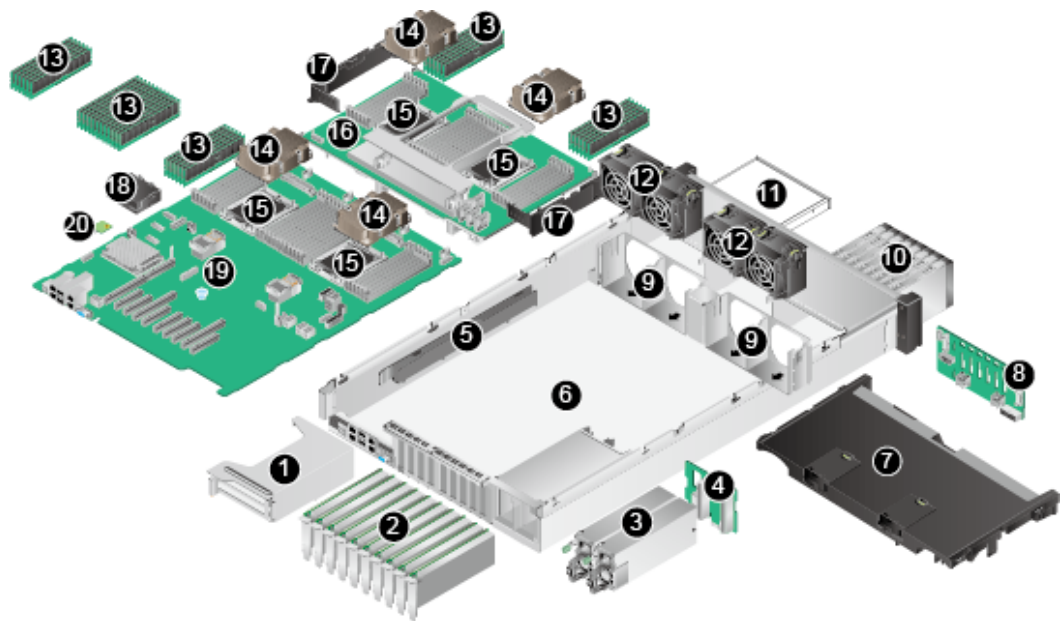

1	Riser card	2	PCIe cards
3	PSUs	4	PSU backplane
5	Cable organizers	6	Chassis
7	Air duct	8	Drive backplane
9	Fan module brackets	10	Drives
11	DVD drive (or LCD)	12	Fan modules
13	DIMMs	14	Heat sinks
15	Processors	16	Daughter board
17	Cable organizers of the daughter board	18	Supercapacitor

19	Mainboard	20	TPM/TCM
----	-----------	----	---------

 **NOTE**

- CPUs 1 and 2 are located on the mainboard, and CPUs 3 and 4 are located on the daughter board.
- If the server is configured with a daughter board, the air duct is not required. If the server is not configured with a daughter board, the air duct is required.

4 Logical Structure

Figure 4-1 2488H V5 logical structure

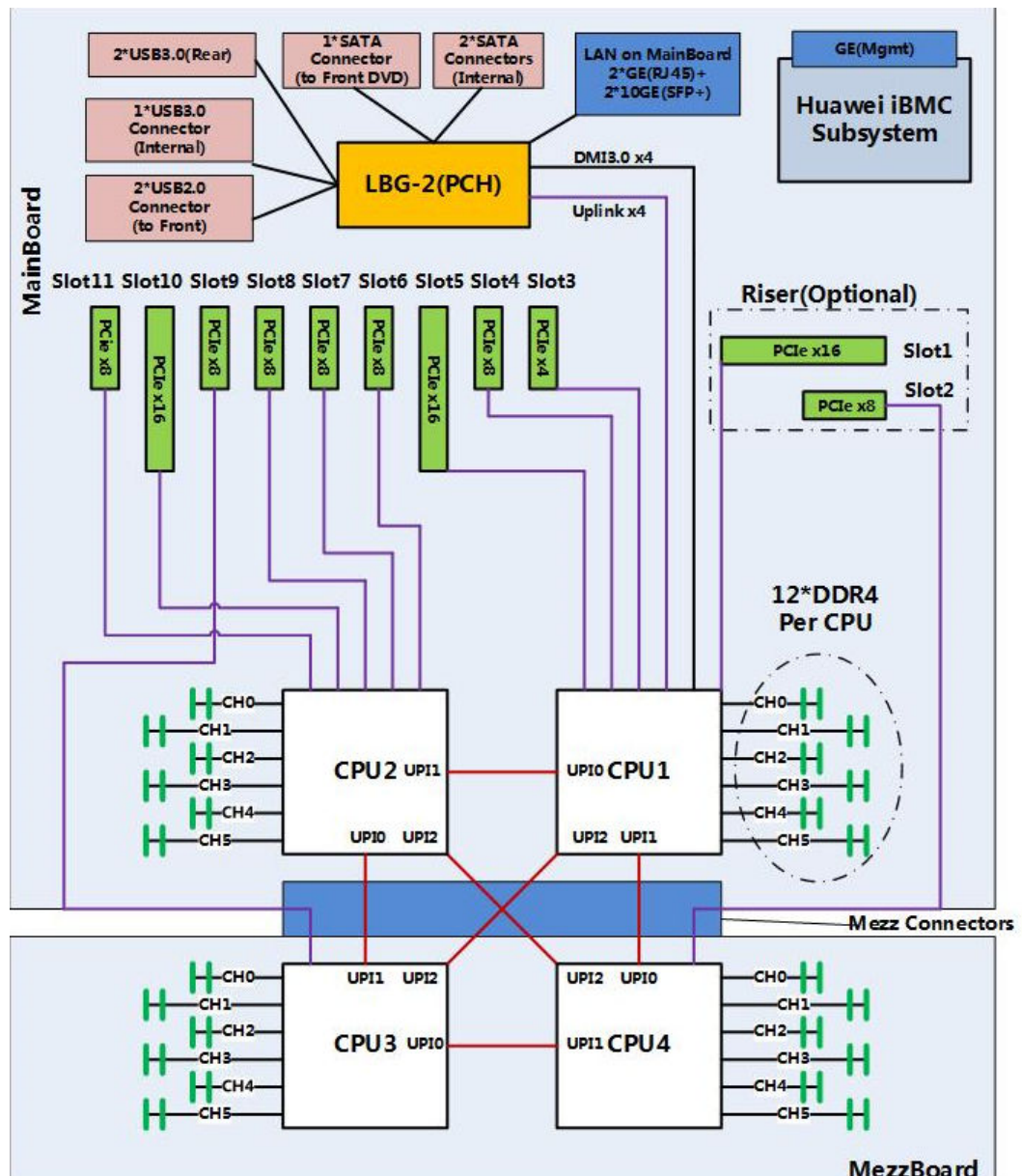

- The server supports two or four Intel® Xeon® Scalable processors.
- The server supports up to 48 memory modules.
- The CPUs (processors) interconnect with each other through three UPI links at a speed of up to 10.4 GT/s.
- The server provides 11 standard PCIe 3.0 slots of various specifications.
- The server provides low-speed I/O ports, such as the VGA port, USB 3.0 ports, and serial ports (RJ45).
- The server provides four LOM ports, including two 10GE optical ports and two GE electrical ports.

5 Hardware Description

- [5.1 Front Panel](#)
- [5.2 Rear Panel](#)
- [5.3 Processor](#)
- [5.4 Memory](#)
- [5.5 Storage](#)
- [5.6 I/O Expansion](#)
- [5.7 PSUs](#)
- [5.8 Fans](#)
- [5.9 LCD](#)
- [5.10 Boards](#)

5.1 Front Panel

5.1.1 Appearance

- 8 x 2.5" SAS/SATA drive configuration

Figure 5-1 Front view

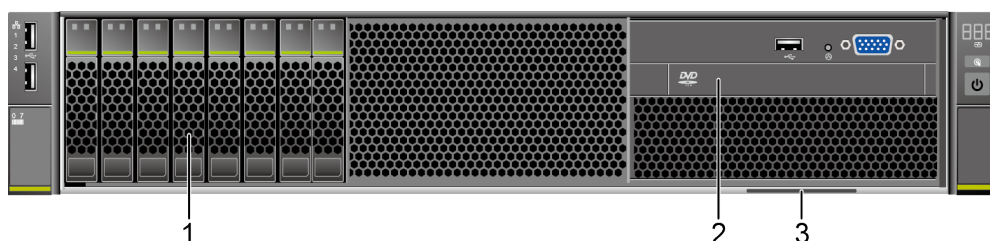

1	Drives	2	Built-in DVD drive or touchable LCD
3	Slide-out label plate (with an SN label)	-	-

- 24 x 2.5" (24 x SAS/SATA or NVMe or 16 x SAS/SATA + 8 x NVMe) drive configuration

Figure 5-2 Front view

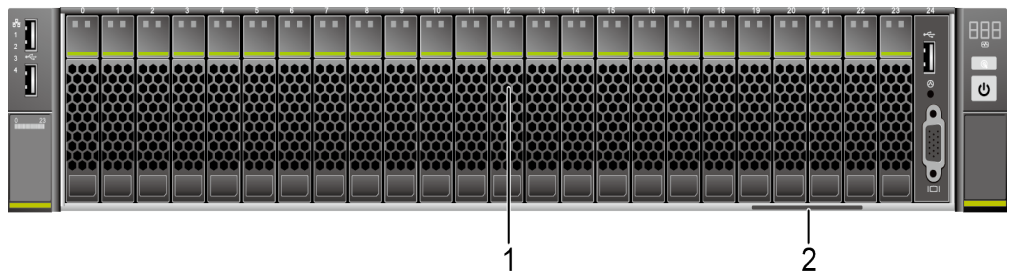

1	Drives	2	Slide-out label plate (with an SN label)
---	--------	---	--

- 25 x 2.5" SAS/SATA drive configuration

Figure 5-3 Front view

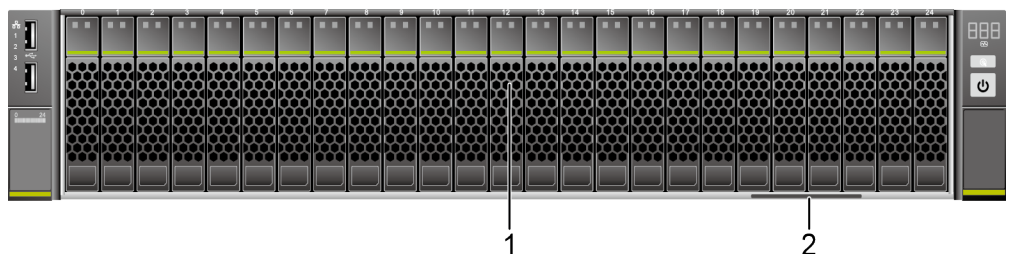

1	Drives	2	Slide-out label plate (with an SN label)
---	--------	---	--

5.1.2 Indicators and Buttons

Positions

- 8 x 2.5" SAS/SATA drive configuration

Figure 5-4 Indicators and buttons on the front panel

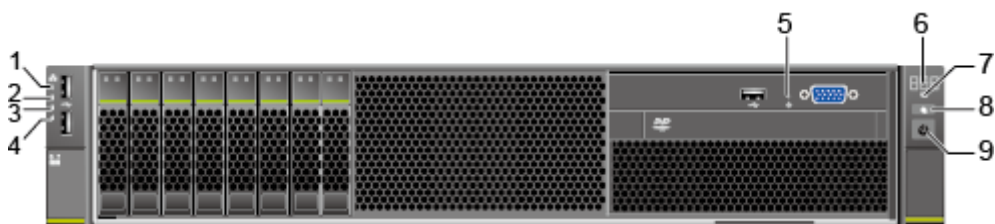

1	LOM port 1 connection status indicator	2	LOM port 2 connection status indicator
3	LOM port 3 connection status indicator	4	LOM port 4 connection status indicator
5	Non-Maskable Interrupt (NMI) button	6	Fault diagnosis LED
7	Health status indicator	8	UID button/indicator
9	Power button/indicator	-	-

- 24 x 2.5" (24 x SAS/SATA or NVMe or 16 x SAS/SATA + 8 x NVMe) drive configuration

Figure 5-5 Indicators and buttons on the front panel

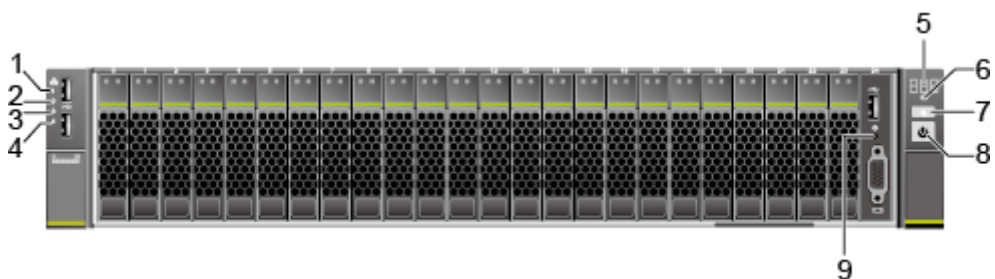

1	LOM port 1 connection status indicator	2	LOM port 2 connection status indicator
3	LOM port 3 connection status indicator	4	LOM port 4 connection status indicator
5	Fault diagnosis LED	6	Health status indicator
7	UID button/indicator	8	Power button/indicator
9	NMI button	-	-

- 25 x 2.5" SAS/SATA drive configuration

Figure 5-6 Indicators and buttons on the front panel





1	LOM port 1 connection status indicator	2	LOM port 2 connection status indicator
3	LOM port 3 connection status indicator	4	LOM port 4 connection status indicator
5	Fault diagnosis LED	6	Health status indicator
7	UID button/indicator	8	Power button/indicator

Indicator and Button Description

Table 5-1 Indicators and buttons on the front panel

Silkscreen	Indicator/ Button	Description
☐☐☐	Fault diagnosis LED	<ul style="list-style-type: none"> ---: The device is operating normally. Fault code: A component is faulty. For details about error codes, see FusionServer Pro Rack Server iBMC Alarm Handling.

Silkscreen	Indicator/ Button	Description
	Power button/ indicator	Power indicator: <ul style="list-style-type: none"> ● Off: The device is not powered on. ● Steady green: The device is powered on. ● Blinking yellow: The power button is locked. The power button is locked when the iBMC is starting. ● Steady yellow: The device is ready to power on. Power button: <ul style="list-style-type: none"> ● When the device is powered on, you can press this button to gracefully shut down the OS. ● When the device is powered on, holding down this button for 6 seconds will forcibly power off the device. ● When the power indicator is steady green, you can press this button to power on the device.
	UID button/ indicator	The UID button/indicator helps identify and locate a device. <p>UID indicator:</p> <ul style="list-style-type: none"> ● Off: The device is not being located. ● Blinking blue: The device has been located and is distinguished from other devices that have also been located. ● Steady blue: The device is being located. <p>UID button:</p> <ul style="list-style-type: none"> ● You can turn on or off the UID indicator by pressing the UID button on the panel or by using the iBMC CLI or WebUI. ● You can press this button to turn on or off the UID indicator. ● You can press and hold down this button for 4 to 6 seconds to reset the iBMC.
	Health status indicator	<ul style="list-style-type: none"> ● Off: The device is powered off or is faulty. ● Blinking red at 1 Hz: A major alarm has been generated on the system. ● Blinking red at 5 Hz: A critical alarm has been generated on the system. ● Steady green: The device is operating properly.

Silkscreen	Indicator/ Button	Description
○	NMI button	<p>A non-maskable interrupt (NMI) is generally triggered to stop the OS for debugging. To trigger an NMI, press this button or click the button on the iBMC WebUI.</p> <p>NOTICE</p> <ul style="list-style-type: none"> Press the NMI button only when the OS is abnormal. Do not press this button when the server is operating properly. An NMI does not gracefully shut down the OS and causes service interruption and data loss. Before pressing the NMI button, ensure that the OS has the NMI processing program. Otherwise, the OS may crash. Exercise caution when pressing this button.
	LOM port connection status indicator	<p>Each indicator shows the connection status of an Ethernet LOM port.</p> <ul style="list-style-type: none"> Off: The network port is not in use or has failed. Steady green: The network port is properly connected. <p>NOTE</p> <ul style="list-style-type: none"> The indicators correspond to two 10GE and two GE network ports on the mainboard. The LOM has a standby power supply and will not be powered off even if the service system is powered off. As long as the LOM ports are properly connected to other working network devices, the network ports will remain connected and the indicators are on.

5.1.3 Ports

Port Positions

- 8 x 2.5" SAS/SATA drive configuration

Figure 5-7 Ports on the front panel



1	USB 2.0 ports	2	USB 3.0 port
---	---------------	---	--------------

3	VGA port	-	-
---	----------	---	---

- 24 x 2.5" (24 x SAS/SATA or NVMe or 16 x SAS/SATA + 8 x NVMe) drive configuration

Figure 5-8 Ports on the front panel



1	USB 2.0 ports	2	USB 3.0 port
3	VGA port	-	-

- 25 x 2.5" SAS/SATA drive configuration

Figure 5-9 Ports on the front panel



1	USB 2.0 ports	-	-
---	---------------	---	---

Port Description

Table 5-2 Ports on the front panel

Port	Type	Quantity ^{Note}	Description
VGA port	DB15	1	Used to connect a display terminal, such as a monitor or KVM.
USB port	USB 2.0	2	Used to connect to a USB device.

Port	Type	Quantity ^{Note}	Description
	USB 3.0	1	NOTICE Before connecting an external USB device, check that the USB device functions properly. The server may operate abnormally if an abnormal USB device is connected.
Note: The number of ports varies depending on server configuration. This table lists the maximum number of ports in different configurations.			

5.2 Rear Panel

5.2.1 Appearance

Figure 5-10 Rear view

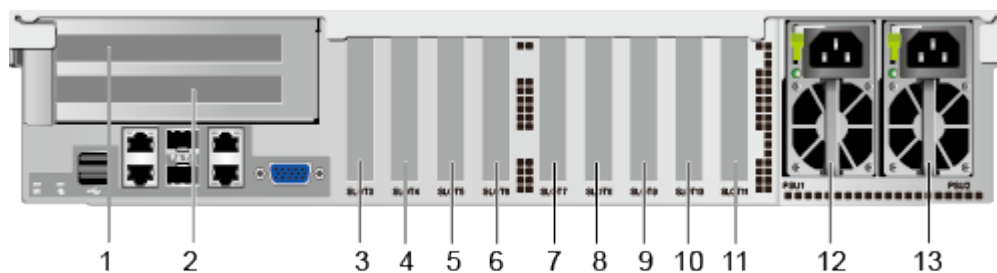

1	PCIe slot 1	2	PCIe slot 2
3	PCIe slot 3	4	PCIe slot 4
5	PCIe slot 5	6	PCIe slot 6
7	PCIe slot 7	8	PCIe slot 8
9	PCIe slot 9	10	PCIe slot 10
11	PCIe slot 11	12	PSU 1
13	PSU 2	-	-

5.2.2 Indicators

Indicator Positions

Figure 5-11 Indicators on the rear panel

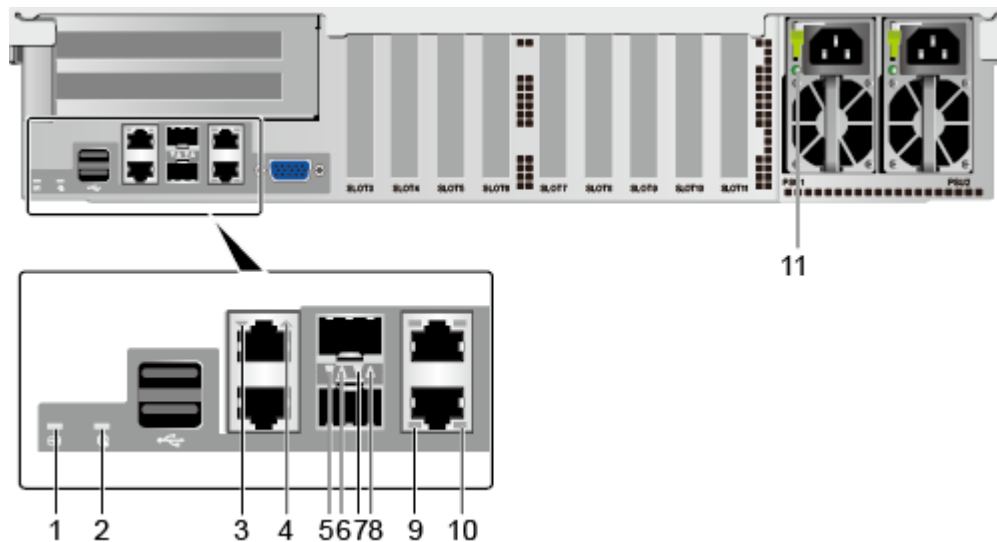

1	Health status indicator	2	UID indicator
3	Connection status indicator/Data transmission status indicator for GE electrical port 1	4	Connection status indicator/Data transmission status indicator for GE electrical port 2
5	Connection status indicator/Data transmission status indicator for 10GE optical port 4	6	Connection status indicator/Data transmission status indicator for 10GE optical port 3
7	Data transmission rate indicator for 10GE optical port 4	8	Data transmission rate indicator for 10GE optical port 3
9	Data transmission status indicator for the management network port	10	Connection status indicator for the management network port
11	PSU indicator	-	-

Indicator Description

Table 5-3 Indicators on the rear panel

Indicator	Description
PSU indicator	<ul style="list-style-type: none"> ● Off: No power is supplied. ● Blinking green at 1 Hz: <ul style="list-style-type: none"> – The input is normal, the server is in standby state, and the PSU is in MV6 mode (output voltage is 6.7 V). – The input is overvoltage or undervoltage. – The PSU is in deep hibernation mode. ● Blinking green at 4 Hz: The firmware is being upgraded online. ● Steady green: The power input and output are normal. ● Steady orange: The input is normal, but no power output is supplied. <p>NOTE The possible causes of no power output are as follows:</p> <ul style="list-style-type: none"> ● Power supply overtemperature protection ● Power output overcurrent or short-circuit ● Output overvoltage ● Short-circuit protection ● Device failure (excluding failure of all devices)
UID indicator	<p>The UID indicator helps identify and locate a device.</p> <ul style="list-style-type: none"> ● Off: The device is not being located. ● Blinking blue: The device has been located and is differentiated from other devices that have also been located. ● Steady blue: The device is being located. <p>NOTE You can turn on or off the UID indicator by pressing the UID button or remotely running a command on the iBMC CLI.</p>
Health status indicator	<ul style="list-style-type: none"> ● Off: The device is powered off or is faulty. ● Blinking red at 1 Hz: A major alarm has been generated on the system. ● Blinking red at 5 Hz: A critical alarm has been generated on the system. ● Steady green: The device is operating properly.
Data transmission status indicator for the management network port	<ul style="list-style-type: none"> ● Off: No data is being transmitted. ● Blinking yellow: Data is being transmitted.

Indicator	Description
Connection status indicator for the management network port	<ul style="list-style-type: none"> Off: The network port is not connected. Steady green: The network port is properly connected.
Connection status indicator/Data transmission status indicator for a GE electrical port	<ul style="list-style-type: none"> Off: The network port is not connected. Blinking green: Data is being transmitted. Steady green: The network port is properly connected.
Connection status indicator/Data transmission status indicator for a 10GE optical port	<ul style="list-style-type: none"> Off: The network port is not connected. Blinking green: Data is being transmitted. Steady green: The network port is properly connected.
Data transmission rate indicator for a 10GE optical port	<ul style="list-style-type: none"> Off: The network port is not connected. Steady green: The data transmission rate is 10 Gbit/s. Steady yellow: The data transmission rate is not 10 Gbit/s.

5.2.3 Ports

Port Positions

Figure 5-12 Ports on the rear panel

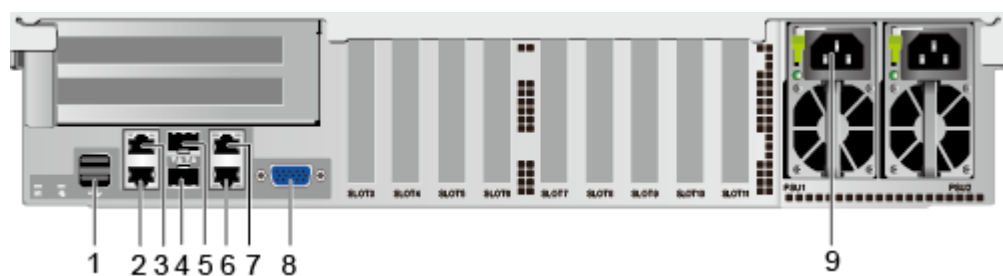

1	USB 3.0 ports	2	GE electrical port (LOM port 2)
3	GE electrical port (LOM port 1)	4	10GE optical port (LOM port 4)
5	10GE optical port (LOM port 3)	6	Management network port
7	Serial port	8	VGA port

9	PSU sockets	-	-
---	-------------	---	---

Port Description

Table 5-4 Ports on the rear panel

Port	Type	Quantity	Description
10GE optical port	10GE SFP+	2	10GE LOM service ports (optical).
GE electrical port	1000BASE-T	2	GE LOM service ports (electrical).
VGA port	DB15	1	Used to connect a display terminal, such as a monitor or KVM.
Serial port	RJ45	1	Default operating system serial port used for debugging. You can also set it as the iBMC serial port by using the iBMC command. NOTE The port uses 3-wire serial communication interface, and the default baud rate is 115,200 bit/s.
Management network port	1000BASE-T	1	Used for server management. NOTE The management network port is a GE port that supports 100 Mbit/s and 1000 Mbit/s auto-negotiation.
USB port	USB 3.0	2	Used to connect to a USB device. NOTICE Before connecting an external USB device, check that the USB device functions properly. The server may operate abnormally if an abnormal USB device is connected.

Port	Type	Quantity	Description
PSU socket	-	2	Used to connect to the power distribution unit (PDU) in the cabinet. You can select the number of power supply units (PSUs) as required. NOTE <ul style="list-style-type: none"> When determining the quantity of PSUs, ensure that the rated power of the PSUs is greater than that of the server. If only one PSU is used, Predicted PSU Status cannot be set to Active/Standby on the iBMC WebUI.

Table 5-5 LOM port description

Chip Model	Port Type	Rate Negotiation Mode	Supported Rate	Rates Not Supported
X722	10GE optical port	Auto-negotiation 10000 Mbit/s (full duplex)	10000M	10/100/1000 M
	GE electrical port	Auto-negotiation 1000 Mbit/s (full duplex)	1000M	10/100M
<ul style="list-style-type: none"> Use Computing Product Compatibility Checker to obtain information about the cables and optical modules supported by the LOM ports. The LOM ports support NC-SI and PXE. The LOM ports do not support forced rates. The electrical LOM ports cannot be connected to power over Ethernet (PoE) devices (such as a switch with PoE enabled). Connecting a LOM port to a PoE device may cause link communication failure or even damage the NIC. The electrical LOM ports do not support SR-IOV. Forcibly powering off a server will cause intermittent NC-SI disconnection and disable the Wake on LAN (WOL) function of the LOM ports. To restore the NC-SI connection, refresh the iBMC WebUI. 				

5.3 Processor

- The server supports two or four processors.
- If two processors are required, install them in sockets **CPU1** and **CPU2**.
- The same model of processors must be used in a server.
- Contact your local Huawei sales representative or use the [Computing Product Compatibility Checker](#) to determine the components to be used.

Figure 5-13 Processor positions

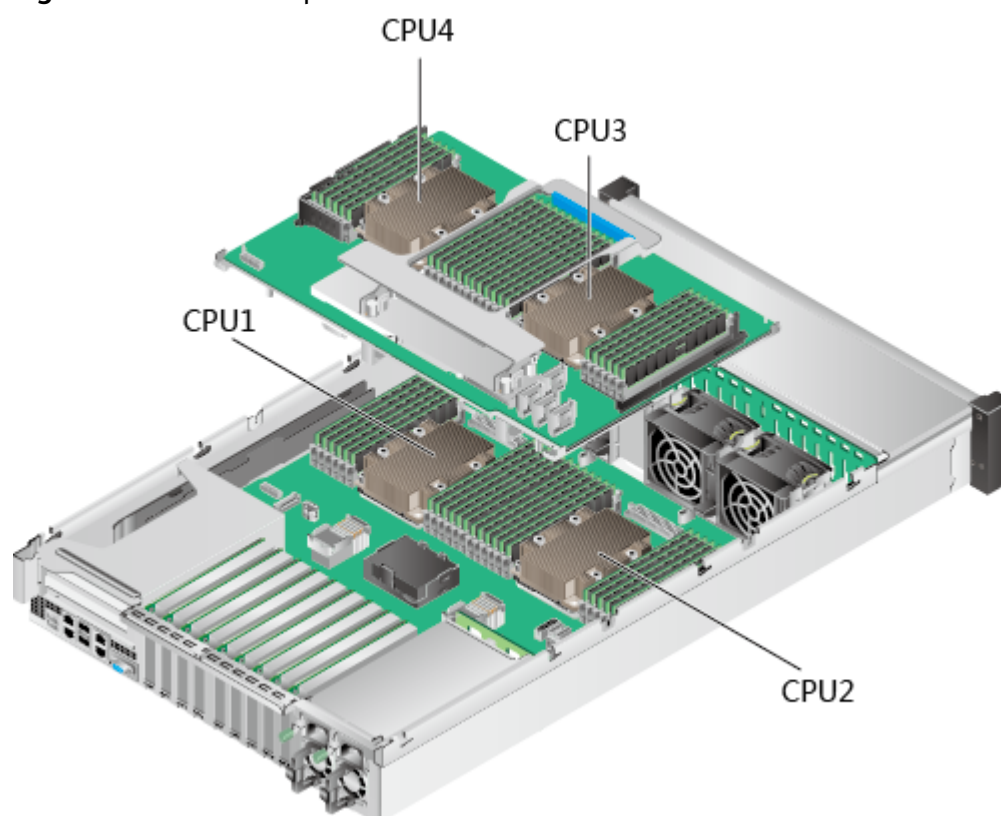

5.4 Memory

5.4.1 Memory Identifier

You can determine the memory module properties based on the label attached to the memory module.

Figure 5-14 Memory identifier

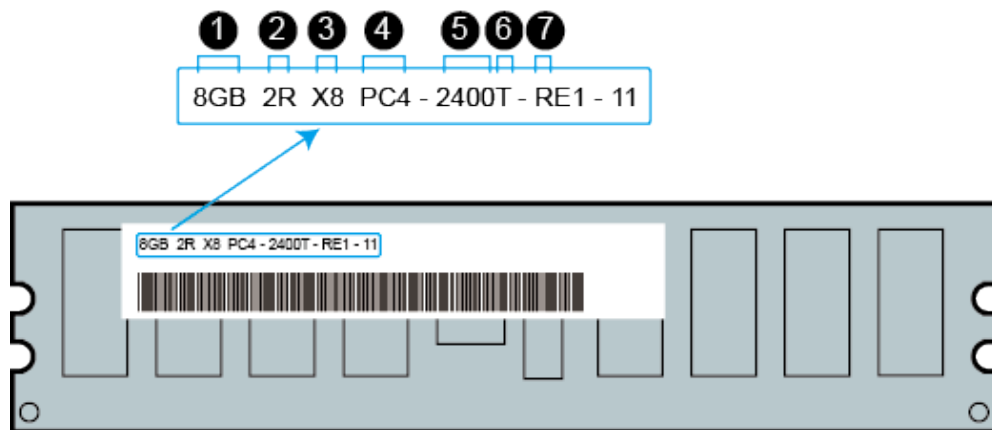

callout	Description	Definition
1	Capacity of the memory module	<ul style="list-style-type: none"> • 8 GB • 16 GB • 32 GB • 64 GB • 128 GB
2	Number of ranks of the memory module	<ul style="list-style-type: none"> • 1R: single-rank • 2R: dual-rank • 4R: quad-rank • 8R: octal-rank
3	Data width on the DRAM	<ul style="list-style-type: none"> • X4: 4-bit • X8: 8-bit
4	Type of the memory interface	<ul style="list-style-type: none"> • PC3: DDR3 • PC4: DDR4
5	Maximum memory speed	<ul style="list-style-type: none"> • 2133 MT/S • 2400 MT/S • 2666 MT/S • 2933 MT/S
6	Column Access Strobe (CAS) latency	<ul style="list-style-type: none"> • P: 15 • T: 17
7	DIMM type	<ul style="list-style-type: none"> • R: RDIMM • L: LRDIMM

5.4.2 Memory Subsystem Architecture

The 2488H V5 provides 48 memory slots. Each processor integrates six memory channels.

Install DIMMs in primary memory channels first. If the primary memory channel is not populated, the DIMMs in secondary memory channels cannot be used.

Table 5-6 Memory channels

CPU	Memory Channel	Memory Slot
CPU 1	A (primary)	DIMM000(A)
	A	DIMM001(G)
	B (primary)	DIMM010(B)
	B	DIMM011(H)
	C (primary)	DIMM020(C)
	C	DIMM021(I)
	D (primary)	DIMM030(D)
	D	DIMM031(J)
	E (primary)	DIMM040(E)
	E	DIMM041(K)
	F (primary)	DIMM050(F)
	F	DIMM051(L)
CPU 2	A (primary)	DIMM100(A)
	A	DIMM101(G)
	B (primary)	DIMM110(B)
	B	DIMM111(H)
	C (primary)	DIMM120(C)
	C	DIMM121(I)
	D (primary)	DIMM130(D)
	D	DIMM131(J)
	E (primary)	DIMM140(E)
	E	DIMM141(K)
	F (primary)	DIMM150(F)
	F	DIMM151(L)

CPU	Memory Channel	Memory Slot
CPU 3	A (primary)	DIMM200(A)
	A	DIMM201(G)
	B (primary)	DIMM210(B)
	B	DIMM211(H)
	C (primary)	DIMM220(C)
	C	DIMM221(I)
	D (primary)	DIMM230(D)
	D	DIMM231(J)
	E (primary)	DIMM240(E)
	E	DIMM241(K)
	F (primary)	DIMM250(F)
	F	DIMM251(L)
CPU 4	A (primary)	DIMM300(A)
	A	DIMM301(G)
	B (primary)	DIMM310(B)
	B	DIMM311(H)
	C (primary)	DIMM320(C)
	C	DIMM321(I)
	D (primary)	DIMM330(D)
	D	DIMM331(J)
	E (primary)	DIMM340(E)
	E	DIMM341(K)
	F (primary)	DIMM350(F)
	F	DIMM351(L)

5.4.3 Memory Compatibility

Observe the following rules when configuring DDR4 DIMMs:

NOTICE

- A server must use the same model of DDR4 DIMMs, and all the DIMMs operate at the same speed, which is the smallest value of:
 - Memory speed supported by a processor
 - Maximum operating speed of a DIMM
 - The DDR4 DIMMs of different types (RDIMM and LRDIMM) and specifications (capacity, bit width, rank, and height) cannot be used together.
 - Contact your local Huawei sales representative or use the [Computing Product Compatibility Checker](#) to determine the components to be used.
-
- The memory can be used with Intel® Xeon® Scalable Skylake and Cascade Lake processors. The maximum memory capacity supported varies depending on the processor model.
 - Skylake processors
 - M processors: 1.5 TB/socket
 - Other processors: 768 GB/socket
 - Cascade Lake processors
 - L processors: 4.5 TB/socket
 - M processors: 2 TB/socket
 - Other processors: 1 TB/socket
 - The total memory capacity is the sum of the capacity of all DDR4 DIMMs.

NOTICE

The total memory capacity cannot exceed the maximum memory capacity supported by the CPUs.

-
- Use the [Computing Product Compatibility Checker](#) to determine the capacity type of a single DIMM.
 - The maximum number of DIMMs supported by a server varies depending on the CPU type, memory type, rank quantity, and operating voltage.

NOTE

Each memory channel supports a maximum of 8 ranks. The number of DIMMs supported by each channel varies depending on the number of ranks supported by each channel:

Number of DIMMs supported by each channel ≤ Number of ranks supported by each memory channel/Number of ranks supported by each DIMM

- A memory channel supports more than eight ranks for LRDIMMs.

NOTE

A quad-rank LRDIMM generates the same electrical load as a single-rank RDIMM on a memory bus.

Table 5-7 DDR4 memory specifications

Parameter		Specifications
Maximum capacity per DDR4 DIMM (GB)		128
Rated speed (MT/s)		2933
Operating voltage (V)		1.2
Maximum number of DDR4 DIMMs in a server ^a		48
Maximum DDR4 memory capacity of the server (GB) ^b		6144
Maximum operating speed (MT/s)	1DPC ^c	2933 ^d
	2DPC	2666
<ul style="list-style-type: none"> • a: The maximum number of DDR4 DIMMs is based on four-processor configuration. The value is halved for a server with two processors. • b: The maximum DDR4 memory capacity varies depending on the processor type. The value listed in this table is based on the assumption that DIMMs are fully configured. • c: DPC (DIMM per channel) indicates the number of DIMMs per channel. • d: If the Cascade Lake processor is used, the maximum operating speed of a DIMM can reach 2933 MT/s. If the Skylake processor is used, the maximum operating speed of a DIMM can reach 2666 MT/s only. 		

5.4.4 Memory Installation Guidelines

- Observe the following when configuring DDR4 DIMMs:
 - Install DIMMs only when corresponding processors are installed.
 - Do not install LRDIMMs and RDIMMs in the same server.
 - Install filler DIMMs in vacant slots.
- Observe the following when configuring DDR4 DIMMs in specific operating mode:
 - Memory sparing mode
 - Comply with the general installation guidelines.
 - Each memory channel must have a valid online spare configuration.
 - The channels can have different online spare configurations.
 - Each populated channel must have a spare rank.
 - Memory mirroring mode
 - Comply with the general installation guidelines.
 - Each processor supports two integrated memory controllers (IMCs). At least two channels of each IMC are used for installing DIMMs

(channels 1 and 2, or channels 1, 2, and 3). The DIMMs installed must be identical in size and organization.

- For a multi-processor configuration, each processor must have a valid memory mirroring configuration.
- Memory scrubbing mode
 - Comply with the general installation guidelines.

5.4.5 Memory Installation Positions

A 2488H V5 supports a maximum of 48 DDR4 DIMMs. To maximize the performance, balance the total memory capacity between the installed processors and load the channels similarly whenever possible.

NOTICE

At least one DDR4 DIMM must be installed in the memory slots corresponding to CPU 1.

CPUs 1 and 2 are located on the mainboard, and CPUs 3 and 4 are located on the daughter board.

- Memory slots on the mainboard

Figure 5-15 Memory slots (mainboard)

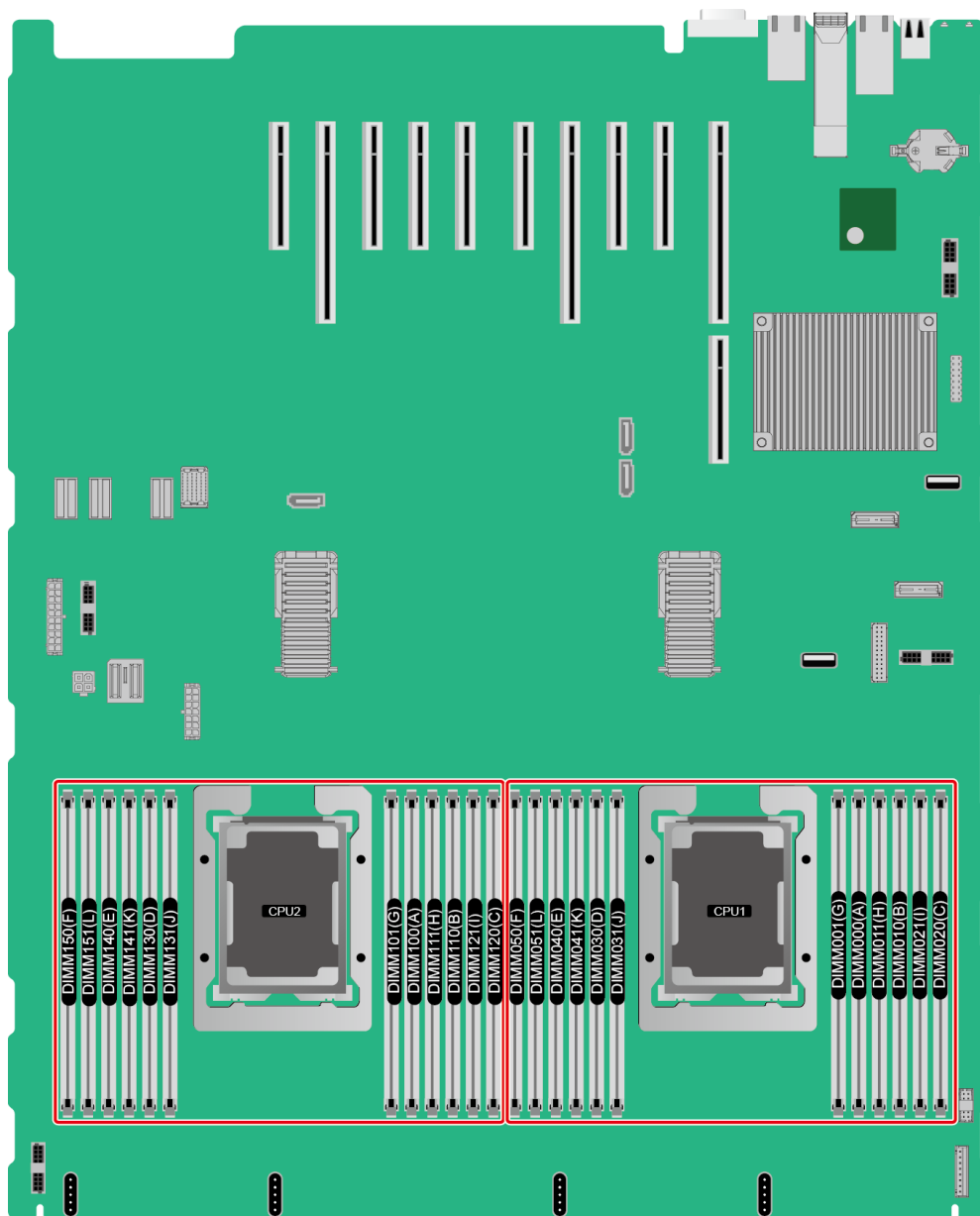

- Memory slots on the daughter board

Figure 5-16 Memory slots (daughter board)

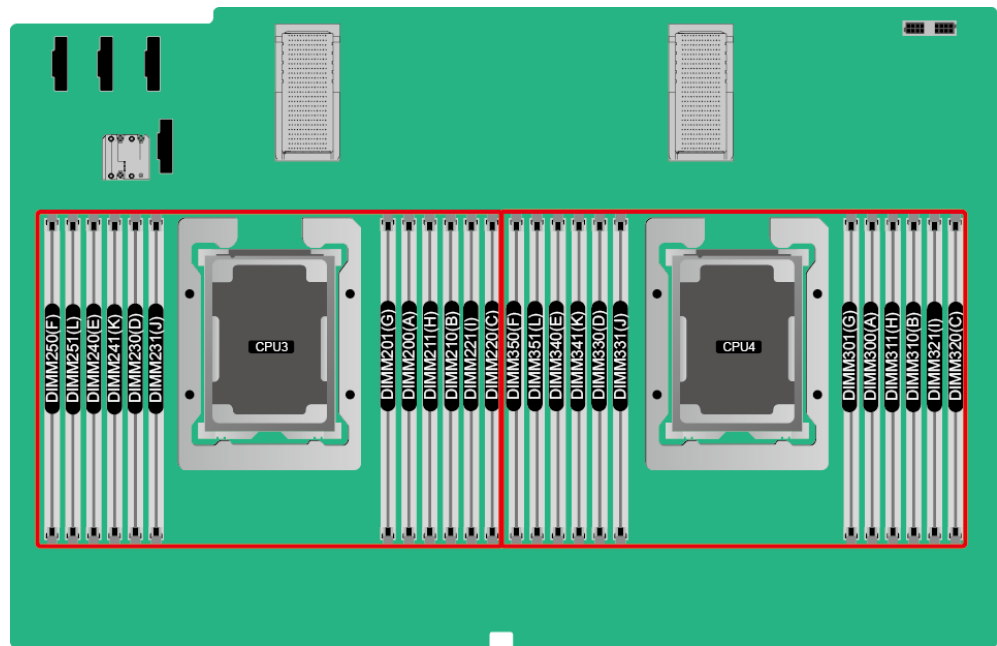

Figure 5-17 DDR4 memory installation guidelines (2 processors)

CPU	Channel	DIMM Slot	Number of DIMMs																							
			(✓: recommended ○: not recommended)																							
			1	2	3	4	5	6	7	8	9	10	11	12	13	14	15	16	17	18	19	20	21	22	23	24
CPU1	A	DIMM000(A)	○	○	○	○	○	○	○	○	○	○	○	○	○	○	○	○	○	○	○	○	○	○	○	
		DIMM001(G)	○	○	○	○	○	○	○	○	○	○	○	○	○	○	○	○	○	○	○	○	○	○	○	
	B	DIMM010(B)	○	○	○	○	○	○	○	○	○	○	○	○	○	○	○	○	○	○	○	○	○	○	○	
		DIMM011(H)	○	○	○	○	○	○	○	○	○	○	○	○	○	○	○	○	○	○	○	○	○	○	○	
	C	DIMM020(C)	○	○	○	○	○	○	○	○	○	○	○	○	○	○	○	○	○	○	○	○	○	○	○	
		DIMM021(I)	○	○	○	○	○	○	○	○	○	○	○	○	○	○	○	○	○	○	○	○	○	○	○	
CPU2	D	DIMM030(D)	○	○	○	○	○	○	○	○	○	○	○	○	○	○	○	○	○	○	○	○	○	○		
		DIMM031(J)	○	○	○	○	○	○	○	○	○	○	○	○	○	○	○	○	○	○	○	○	○	○		
	E	DIMM040(E)	○	○	○	○	○	○	○	○	○	○	○	○	○	○	○	○	○	○	○	○	○	○		
		DIMM041(K)	○	○	○	○	○	○	○	○	○	○	○	○	○	○	○	○	○	○	○	○	○	○		
	F	DIMM050(F)	○	○	○	○	○	○	○	○	○	○	○	○	○	○	○	○	○	○	○	○	○	○		
		DIMM051(L)	○	○	○	○	○	○	○	○	○	○	○	○	○	○	○	○	○	○	○	○	○	○		

5.5 Storage

5.5.1 Drive Configurations

Table 5-8 Drive configurations

Configuration	Maximum Front Drives	Drive Management Mode
8 x 2.5" SAS/SATA drive configuration	8 <ul style="list-style-type: none"> • Slots 0 to 7 support only SAS/SATA drives. 	1 x RAID controller card
24 x 2.5" SAS/SATA drive configuration	24 <ul style="list-style-type: none"> • Slots 0 to 23 support only SAS/SATA drives. 	3 x RAID controller card
24 x 2.5" NVMe drive configuration	<ul style="list-style-type: none"> • 24 <ul style="list-style-type: none"> – Slots 0 to 23 support NVMe drives. 	CPU (directly connected through the NVMe adapter)
24 x 2.5" (16 x SAS/SATA + 8 x NVMe) drive configuration	24 <ul style="list-style-type: none"> • Slots 0 to 3 and slots 20 to 23 support only NVMe drives. • Slots 4 to 19 support only SAS/SATA drives. 	1 x RAID controller card + 2 x NVMe adapter
25 x 2.5" SAS/SATA drive configuration	25 <ul style="list-style-type: none"> • Slots 0 to 24 support only SAS/SATA drives. 	1 x RAID controller card
<ul style="list-style-type: none"> • a: A RAID controller card is required only when SAS or SATA drives are installed in front slots 0 to 3. • Contact your local Huawei sales representative or use the Computing Product Compatibility Checker to determine the components to be used. 		

5.5.2 Drive Numbering

- 8 x 2.5" SAS/SATA drive configuration

Figure 5-19 Drive numbering



- 24 x 2.5" (24 x SAS/SATA or NVMe or 16 x SAS/SATA + 8 x NVMe) drive configuration

Figure 5-20 Drive numbering



- 25 x 2.5" SAS/SATA drive configuration

Figure 5-21 Drive numbering



5.5.3 Drive Indicators

SAS/SATA Drive Indicators

Figure 5-22 SAS/SATA drive indicators

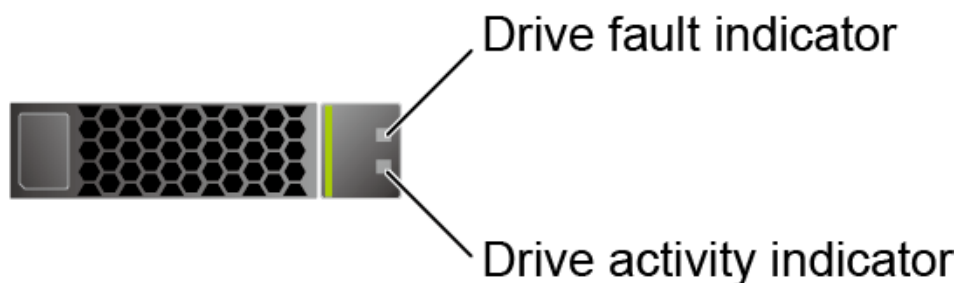

Table 5-9 Description of SAS/SATA drive indicators

Activity Indicator (Green)	Fault Indicator (Yellow)	Description
Steady on	Off	The drive is in position.
Blinking at 4 Hz	Off	Data is being read or written normally, or data on the primary drive is being rebuilt.
Steady on	Blinking at 1 Hz	The drive is being located.
Blinking at 1 Hz	Blinking at 1 Hz	The data on the secondary drive is being rebuilt.

Activity Indicator (Green)	Fault Indicator (Yellow)	Description
Off	Steady on	A member drive in the RAID array is removed.
Steady on	Steady on	The drive is faulty.

NVMe Drive Indicators

Figure 5-23 NVMe drive indicators

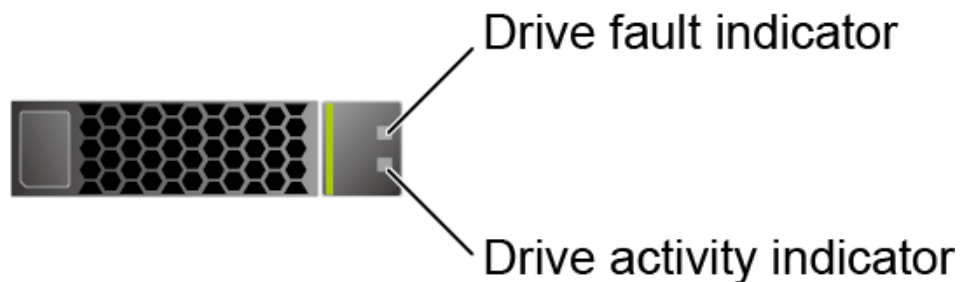

Table 5-10 Description of NVMe drive indicators (only orderly hot swap supported)

Activity Indicator (Green)	Fault Indicator (Yellow)	Description
Off	Off	The NVMe drive cannot be detected.
Steady on	Off	The NVMe drive is working properly.
Blinking at 2 Hz	Off	Data is being read from or written to the NVMe drive.
Off	Blinking at 2 Hz	The NVMe drive is being located or hot-swapped.
Off	Blinking at 0.5 Hz	The hot removal process is complete, and the NVMe drive is removable.
Steady on/Off	Steady on	The NVMe drive is faulty.

5.5.4 RAID Controller Card

The RAID controller card supports RAID configuration, RAID level migration, and drive roaming.

- Contact your local Huawei sales representative or use the [Computing Product Compatibility Checker](#) to determine the components to be used.
- For details about the RAID controller card, see [Huawei V5 Server RAID Controller Card User Guide](#).

5.6 I/O Expansion

5.6.1 PCIe Cards

PCIe cards provide ease of expandability and connection.

- Contact your local Huawei sales representative or use the [Computing Product Compatibility Checker](#) to determine the components to be used.

5.6.2 PCIe Slots

PCIe Slots

Figure 5-24 PCIe slots



- Slots 1 and 2 are provided by the PCIe riser module.
- Slots 3 to 11 are provided by the mainboard.

5.6.3 PCIe Slot Description

NOTE

The PCIe slots mapping to a vacant CPU socket are unavailable.

Table 5-11 PCIe slot description

PCIe Slot	CPU	PCIe Standards	Connector Width	Bus Width	Port No.	Bus/ Device/ Function Number (B/D/F)	Slot Size
LOM	CPU 1	PCIe 3.0	-	x4	Port2D	0x24/0x03/0x00	-
Slot 1	CPU 1	PCIe 3.0	x16	x16	Port3A	0x32/0x00/0x00	Full-height, 3/4-length

PCIe Slot	CPU	PCIe Standards	Connector Width	Bus Width	Port No.	Bus/Device/Function Number (B/D/F)	Slot Size
Slot 2	CPU 4	PCIe 3.0	x8	x8	Port2A	0xE2/0x00/0x00	FHHL
Slot 3	CPU 1	PCIe 3.0	x8	x4	Port2C	0x24/0x02/0x00	HHHL
Slot 4	CPU 1	PCIe 3.0	x8	x8	Port2A	0x24/0x00/0x00	HHHL
Slot 5	CPU 1	PCIe 3.0	x16	x16	Port1A	0x08/0x00/0x00	HHHL
Slot 6	CPU 2	PCIe 3.0	x8	x8	Port2C	0x62/0x02/0x00	HHHL
Slot 7	CPU 2	PCIe 3.0	x8	x8	Port2A	0x62/0x00/0x00	HHHL
Slot 8	CPU 2	PCIe 3.0	x8	x8	Port1A	0x43/0x00/0x00	HHHL
Slot 9	CPU 3	PCIe 3.0	x8	x8	Port2A	0xA2/0x00/0x00	HHHL
Slot 10	CPU 2	PCIe 3.0	x16	x16	Port3A	0x71/0x00/0x00	HHHL
Slot 11	CPU 2	PCIe 3.0	x8	x8	Port1C	0x43/0x02/0x00	HHHL
<ul style="list-style-type: none"> • The B/D/F (Bus/Device/Function Number) values are the default values when the server is fully configured with PCIe devices. The values may vary if the server is not fully configured with PCIe devices or if a PCIe card with a PCI bridge is configured. • The PCIe x16 slots are backward compatible with PCIe x8, PCIe x4, and PCIe x1 cards. The PCIe cards are not forward compatible. That is, the PCIe slot width cannot be smaller than the PCIe card link width. • The full-height 3/4-length PCIe slots are backward compatible with FHHL or HHHL PCIe cards. • All slots support PCIe cards of up to 75 W. The power of a PCIe card varies depending on its model. 							

5.7 PSUs

- The server supports one or two PSUs.
- The server supports AC or DC PSUs.
- The PSUs are hot-swappable.
- The server supports two PSUs in 1+1 redundancy.
- The same model of PSUs must be used in a server.
- The PSUs are protected against short circuit. Double-pole fuse is provided for the PSUs with dual input live wires.
- Contact your local Huawei sales representative or use the [Computing Product Compatibility Checker](#) to determine the components to be used.

NOTE

For a server configured with one or two 1500 W Platinum AC PSUs:

- When the input voltage is from 100 V AC to 132 V AC, the output power drops to 1000 W.
- Two 1500 W AC Platinum PSUs can serve as 1700 W PSUs.

Figure 5-25 PSU positions

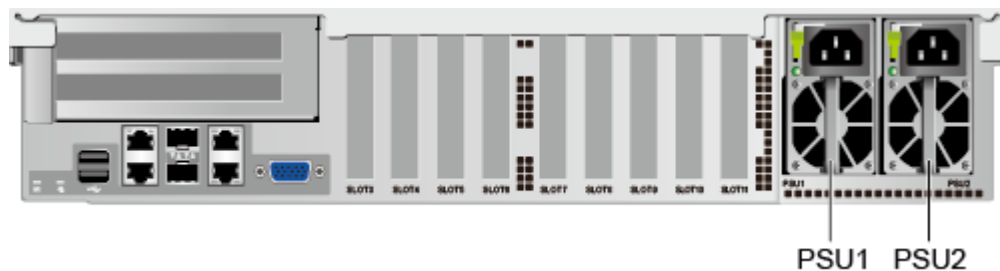

5.8 Fans

- The server supports four fan modules.
- The fan modules are hot-swappable.
- The server tolerates failure of a single fan.
- The fan speed can be adjusted.
- The same model of fan modules must be used in a server.

Figure 5-26 Fan module positions

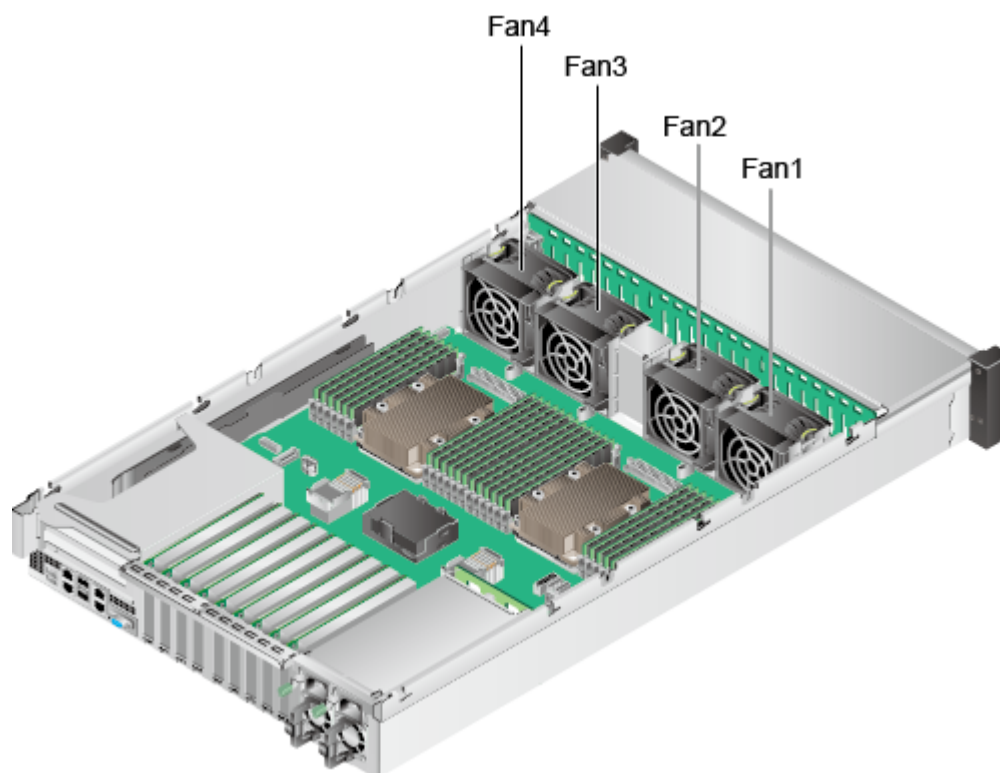

5.9 LCD

Functions

The LCD displays the installation status and running status of server components and enables users to set the IP address of the iBMC management network port on the server.

The LCD and the server iBMC form an LCD subsystem. The LCD directly obtains device information from the iBMC. The LCD subsystem does not store device data, but allows users to query device status and alarms.

Figure 5-27 LCD subsystem working principle

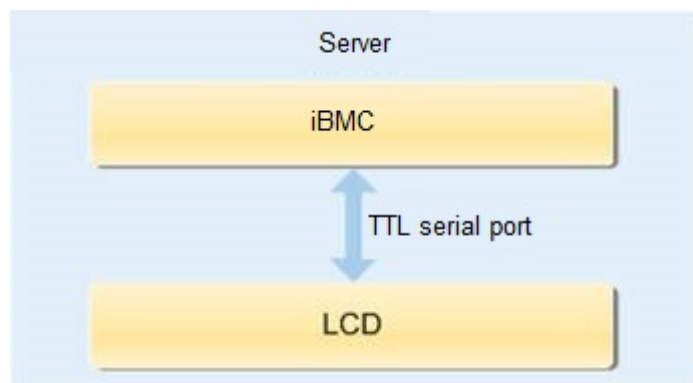

Interface

Figure 5-28 LCD module interface

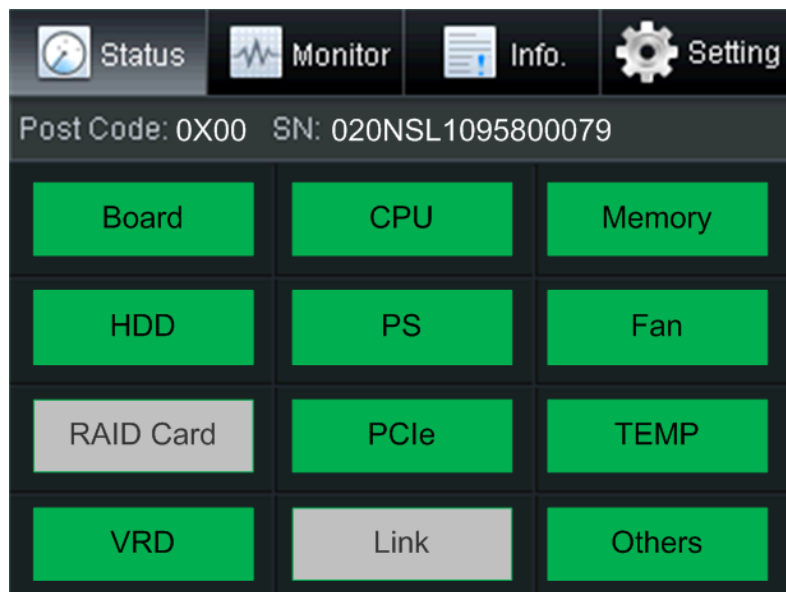

Tab Name	Function
Status	Displays the port 80 status, serial number, component status, and component alarms of the server.
Monitor	Displays the current power of the server, CPU temperature, and inlet temperature.
Info.	Displays the IP address and MAC address of the iBMC management network port, MAC addresses of host LOM ports, device SNs, asset information, and firmware version.
Setting	Sets the IP address of the iBMC management network port.

For details about how to use the LCD, see [2488H V5 Server V100R005 LCD User Guide](#).

5.10 Boards

5.10.1 Mainboard

Figure 5-29 2488H V5 mainboard

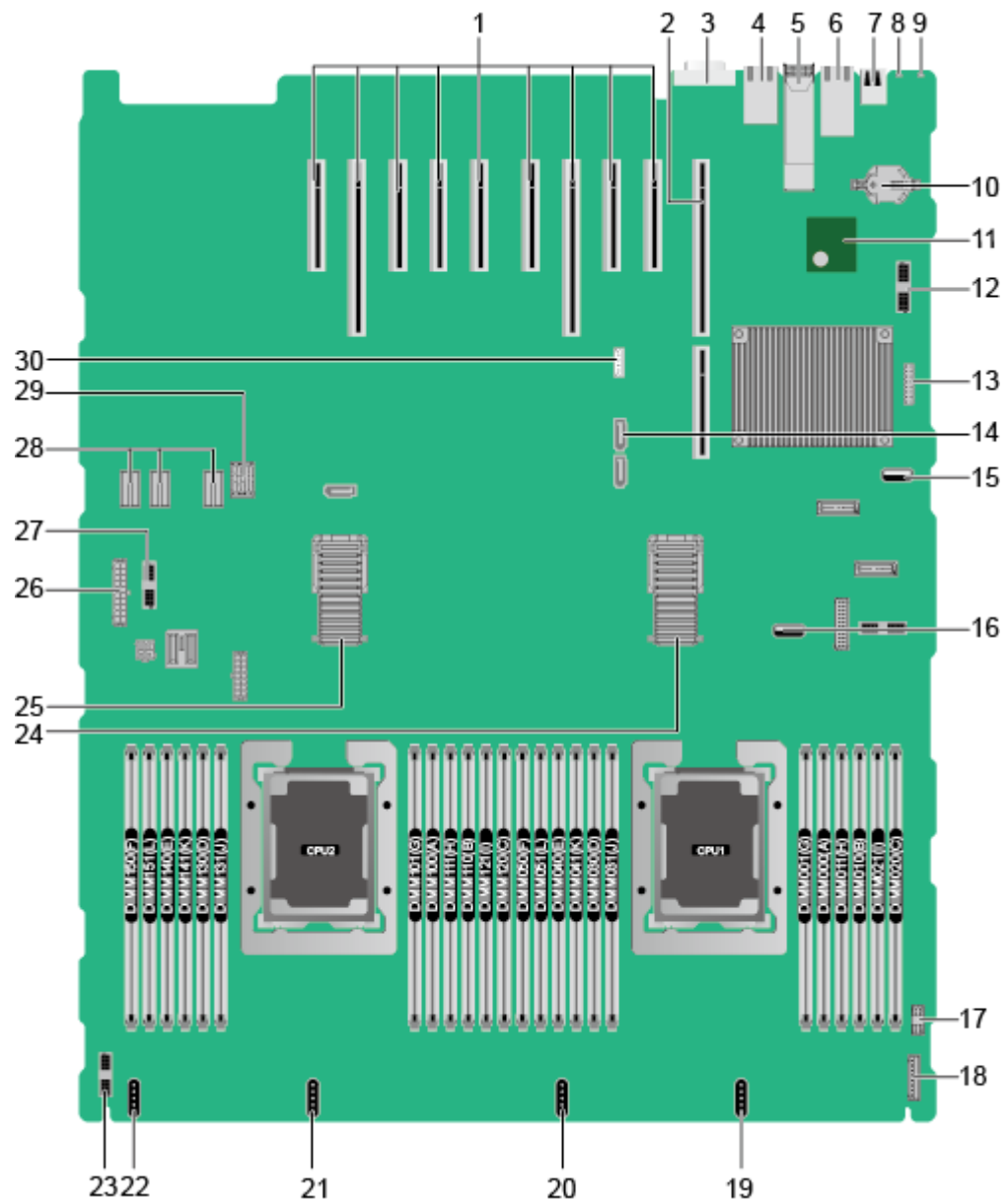

1	PCIe card slots (3 to 11 from right to left)	2	PCIe riser slots (J207 for CPU 1 and J230 for CPU 4)
3	VGA connector (VGA CONN/J169)	4	System serial port and management network port (J242) ^a
5	10GE optical port (10GE PORT0&PORT1/J140)	6	GE electrical port (GE PORT2&PORT3/J138)

7	USB 3.0 port (REAR USB3.0/J172)	8	UID indicator
9	Health status indicator	10	System battery (U4042)
11	TPM port (TPM CONN/J55)	12	Right mounting ear connector (J131)
13	Jumper (J93) ^b	14	SATA DVD drive connector (J130)
15	USB 3.0 port (FRONT USB3.0/J190) ^c	16	USB 3.0 port (INNER USB3.0/J182)
17	VGA connector (J233)	18	LCD connector (LCD CONN/J87)
19	Fan port 4 (FAN4/J102)	20	Fan port 3 (FAN3/J103)
21	Fan port 2 (FAN2/J104)	22	Fan port 1 (FAN1/J105)
23	Drive backplane signal connector (HDD BP/J235)	24	High-speed backplane connector (J244) ^d
25	High-speed backplane connector (J243) ^d	26	Drive backplane power connector (BP PWR/J237)
27	Left mounting ear connector (LEFT EAR CONN BOARD/J115)	28	PSU backplane power connectors (J225/J226/J239)
29	PSU backplane signal connectors (J238)	30	VROC key port (J144) ^e
<ul style="list-style-type: none"> • a: The upper one is an RJ45 serial port, and the lower one is an RJ45 management port. • b: The BMC_SER_MANUAL pin is used for changing the connection direction of the physical serial port. The CLEAR_BMC_PW pin is used for restoring default iBMC settings. • c: The built-in USB 3.0 port can be connected to the front USB 3.0 port through a USB cable. It cannot be used directly. • d: CPUs 1 and 2 are on the mainboard, and CPUs 3 and 4 are on the daughter board. The mainboard and daughter board are interconnected through high-speed backplane connectors. • e: The port is reserved. 			

5.10.2 Daughter Board

Figure 5-30 shows the daughter board of the 2488H V5. **Figure 5-31** shows the connection between the daughter board and the mainboard.

NOTE

CPU 1 and 2 are on the mainboard, and CPUs 3 and 4 are on the daughter board. The mainboard and daughter board are interconnected through high-speed backplane connectors.

Figure 5-30 Daughter board

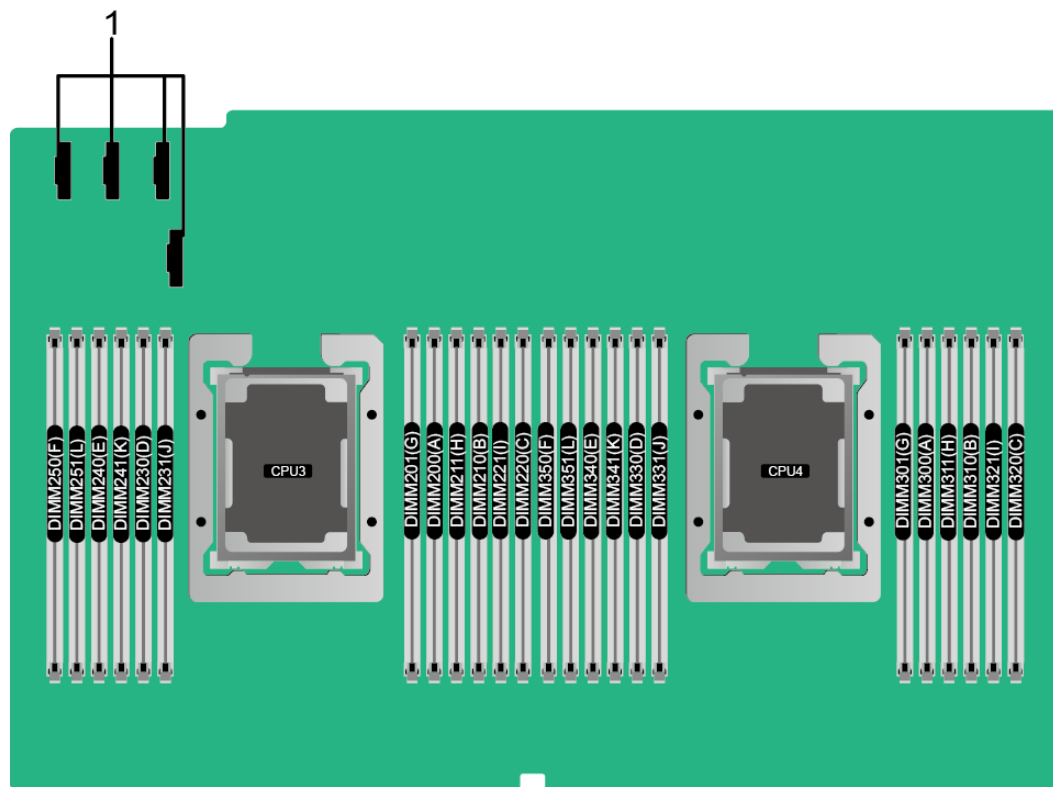

1	Slimline connectors for connecting the daughter board and the mainboard (reserved)	-	-
---	--	---	---

Figure 5-31 Connection between the daughter board and the mainboard

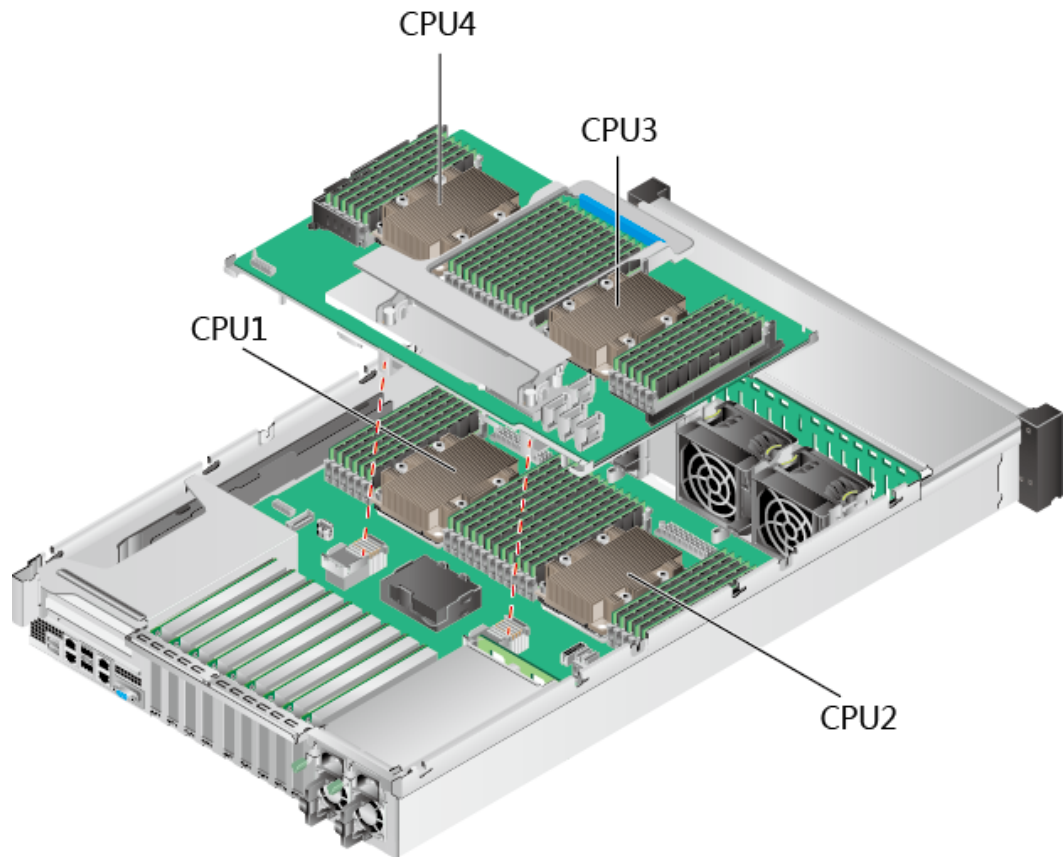

5.10.3 Drive Backplane

- 8 x 2.5" SAS/SATA drive backplane

Figure 5-32 8 x 2.5" SAS/SATA drive backplane

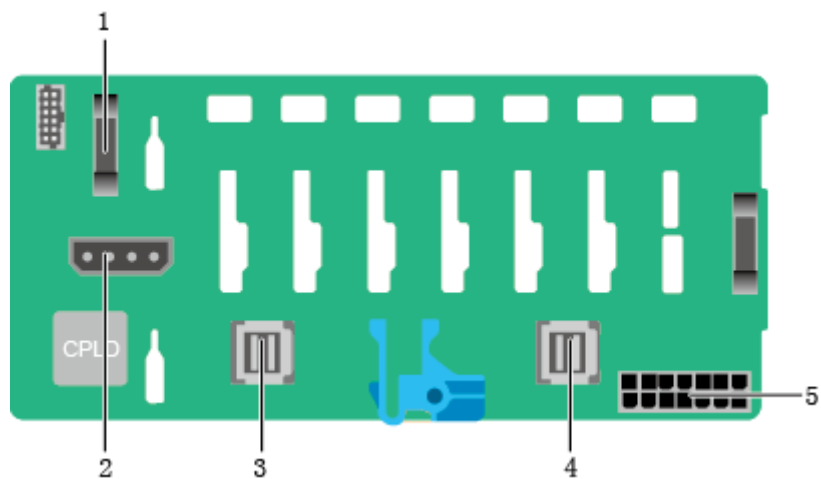

1	Signal cable connector (J1)	2	DVD drive power connector (J11)
---	-----------------------------	---	---------------------------------

3	SAS cable connector (PORT B/J29)	4	SAS cable connector (PORT A/J28)
5	Backplane power connector (J24)	-	-

- 24 x 2.5" SAS/SATA drive backplane

Figure 5-33 24 x 2.5" SAS/SATA drive backplane

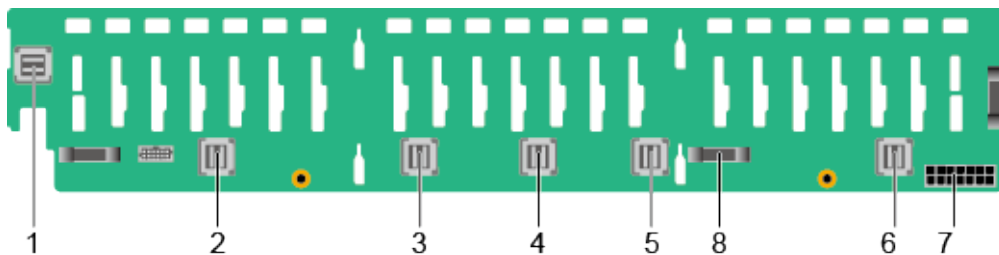

1	SAS cable connector (PORT 3B/J33)	2	SAS cable connector (PORT 3A/J39)
3	SAS cable connector (PORT 2B/J31)	4	SAS cable connector (PORT 2A/J30)
5	SAS cable connector (PORT 1B/J29)	6	SAS cable connector (PORT 1A/J28)
7	Backplane power connector (J24)	8	Backplane signal cable connector (J1)

- 24 x 2.5" (16 x SAS/SATA + 8 x NVMe) drive backplane

Figure 5-34 24 x 2.5" (16 x SAS/SATA + 8 x NVMe) drive backplane

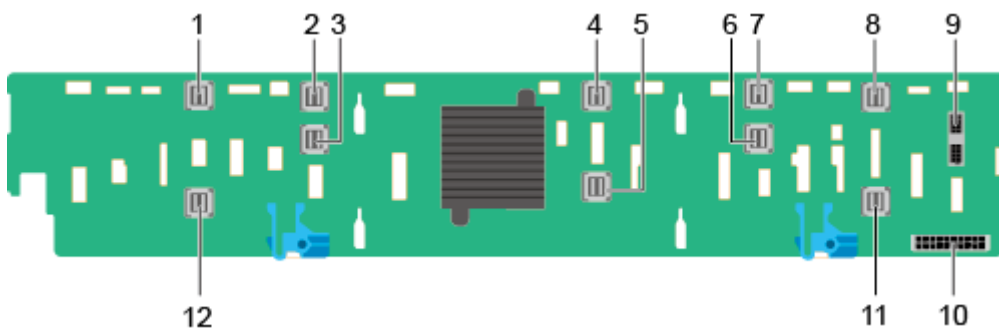

1	NVMe (PORT B_N2/J26)	2	NVMe (PORT B_N0/J24)
3	NVMe (PORT B_N1/J25)	4	SAS cable connector (PORT C_0/J28)

5	SAS cable connector (PORT C_1/J29)	6	NVMe (PORT A_N1/J21)
7	NVMe (PORT A_N0/J20)	8	NVMe (PORT A_N2/J22)
9	Backplane signal cable connector (J1)	10	Backplane power connector (J3)
11	NVMe (PORT A_N3/J23)	12	NVMe (PORT B_N3/J27)

- 24 x 2.5" NVMe drive backplane

Figure 5-35 24 x 2.5" NVMe drive backplane

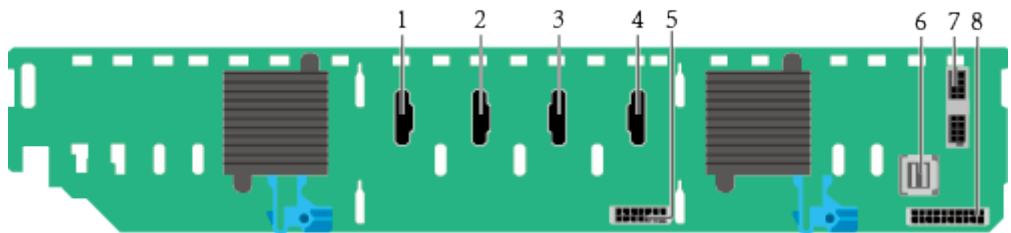

1	Slimline A connector (J6)	2	Slimline B connector (J5)
3	Slimline C connector (J7)	4	Slimline D connector (J8)
5	Power connector 2 (J34)	6	mini-SAS HD connector (PORT A/J52)
7	Backplane signal cable connector (J3)	8	Power connector 1 (J2)

- 25 x 2.5" SAS/SATA drive backplane

Figure 5-36 25 x 2.5" SAS/SATA drive backplane

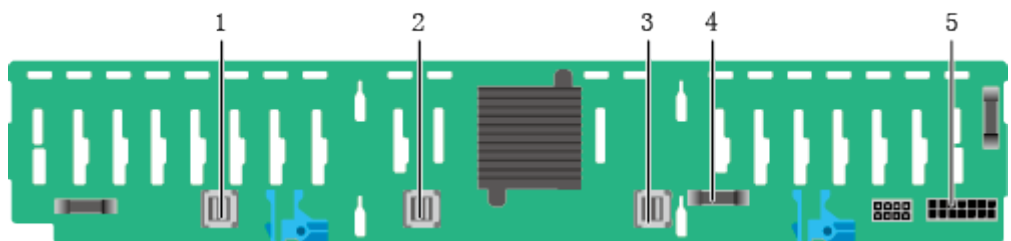

1	SAS cable connector (PORT A/J28)	2	SAS cable connector (PORT B/J29)
3	SAS cable connector (REAR PORT/J31)	4	Backplane signal cable connector (J1)
5	Backplane power connector (J24)	-	-

6 Product Specifications

[6.1 Technical Specifications](#)

[6.2 Environmental Specifications](#)

[6.3 Physical Specifications](#)

6.1 Technical Specifications

Table 6-1 Technical specifications

Category	Specifications
Form factor	2U rack server
Chipset	Intel® C622
Processors	<p>Supports two or four processors.</p> <ul style="list-style-type: none">• Intel® Xeon® Scalable (Skylake and Cascade Lake) processors• Built-in memory controller and six memory channels• Built-in PCIe controller, supporting PCIe 3.0 and 48 lanes per processor• Three UPI buses between processors, providing up to 10.4GT/s transmission per channel• Up to 28 cores (2.7 GHz)• Max. 3.8 GHz (four cores)• Min. 1.375 MB L3 cache per core• Max. 205 W TDP <p>NOTE The preceding information is for reference only. Use the Computing Product Compatibility Checker to obtain specific information.</p>

Category	Specifications
Memory	<p>Supports 48 memory modules of the following types:</p> <ul style="list-style-type: none">• Up to 48 DDR4 memory modules• Max. 2933 MT/s memory speed• RDIMM and LRDIMM support• The DDR4 memory modules of different types (RDIMM and LRDIMM) and specifications (capacity, bit width, rank, and height) cannot be used together. <p>NOTE The preceding information is for reference only. Use the Computing Product Compatibility Checker to obtain specific information.</p>

Category	Specifications
Storage	<p>Supports a variety of drive configurations. For details, see 5.5.1 Drive Configurations.</p> <ul style="list-style-type: none"> ● Supports two M.2 SSDs. <ul style="list-style-type: none"> – M.2 SSDs are supported only when the server is configured with an Avago SAS3004iMR RAID controller card. – The drive letter of the M.2 SSDs managed by the Avago SAS3004iMR RAID controller card can be set to sda by modifying the GRUB parameters only when the RAID controller card is used with a SmartRAID 3152-8i or SmartHBA 2100-8i RAID controller card. <p>NOTE</p> <ul style="list-style-type: none"> ● The M.2 SSD module is used only as the boot device when the OS is installed. Small-capacity (32 GB or 64 GB) M.2 SSDs do not support logging due to poor endurance. If a small-capacity M.2 SSD is used as the boot device, a dedicated log drive or log server is required for logging. For example, you can dump VMware logs in either of the following ways: <ul style="list-style-type: none"> ● Redirect /scratch. For details, see https://kb.vmware.com/s/article/1033696. ● Configure syslog. For details, see https://kb.vmware.com/s/article/2003322. ● The M.2 SSD cannot be used to store data due to poor endurance. In write-intensive applications, the M.2 SSD will wear out in a short time. Use enterprise-level high endurance (HE) SSDs or HDDs for data storage. ● The M.2 SSD is not recommended for write-intensive service software due to poor endurance. ● Do not use the M.2 SSD as the cache. <ul style="list-style-type: none"> ● Supports hot swap of SAS/SATA drives. ● Supports a variety of RAID controller cards. Use the Computing Product Compatibility Checker to obtain information about the specific RAID controller cards supported. <ul style="list-style-type: none"> – The RAID controller card supports RAID configuration, RAID level migration, and drive roaming. – The PCIe RAID controller card occupies one standard PCIe slot. <p>For details about the RAID controller card, see Huawei V5 Server RAID Controller Card User Guide.</p> ● Supports a SAS RAID controller card (with a 1 GB, 2 GB, or 4 GB cache) and a supercapacitor (providing

Category	Specifications
	power-off protection) to improve storage performance and data security.
Network	Supports LOM. <ul style="list-style-type: none"> • Supports two 10GE optical ports and two GE electrical ports via the NIC chip integrated on the mainboard. • The LOM ports support NC-SI and PXE. NOTE The electrical LOM ports cannot be connected to PoE devices (such as a switch with PoE enabled). Connecting a LOM port to a PoE device may cause link communication failure or even damage the NIC.
I/O expansion	11 PCIe 3.0 slots: <ul style="list-style-type: none"> • Two slots for riser cards and nine onboard slots. For details, see 5.6.2 PCIe Slots and 5.6.3 PCIe Slot Description. • Support Huawei proprietary PCIe SSD cards to bolster I/O performance for applications such as searching, caching, and download services. NOTE The preceding information is for reference only. Use the Computing Product Compatibility Checker to obtain specific information.

Category	Specifications
Ports	<p>Supports a variety of ports.</p> <ul style="list-style-type: none"> ● Ports on the front panel: <ul style="list-style-type: none"> - Two USB 2.0 ports - One USB 3.0 port - One DB15 VGA port <p>NOTE For the server that uses 25 x 2.5" drive configuration, the front panel provides only two USB 2.0 ports.</p> <ul style="list-style-type: none"> ● Ports on the rear panel: <ul style="list-style-type: none"> - Two USB 3.0 ports - One DB15 VGA port - One RJ45 serial port - One RJ45 system management port - Two GE electrical ports - Two 10GE optical ports ● Built-in ports: <ul style="list-style-type: none"> - Two USB 3.0 ports <p>NOTE In the 8 x 2.5" or 24 x 2.5" drive configuration, only one USB3.0 built-in port is provided.</p> <p>NOTE You are not advised to install the operating system on the USB storage media.</p>
Video card	<p>An SM750 video chip with 32 MB display memory is integrated on the mainboard. The maximum display resolution is 1920 x 1200 at 60 Hz with 16 M colors.</p> <p>NOTE</p> <ul style="list-style-type: none"> ● The integrated video card can provide the maximum display resolution (1920 x 1200) only after the video card driver matching the operating system version is installed. Otherwise, only the default resolution supported by the operating system is provided. ● If the chassis provides the front and rear VGA ports but only one VGA port is connected to a monitor, the display effect may be affected.
System management	<ul style="list-style-type: none"> ● UEFI ● iBMC ● NC-SI ● Integration with third-party management systems

Category	Specifications
Security features	<ul style="list-style-type: none"> • Power-on password • Administrator password • TCM (only in China)/TPM • Secure boot • Front bezel (optional)

6.2 Environmental Specifications

Table 6-2 Environmental specifications

Category	Specifications
Temperature	<ul style="list-style-type: none"> • Operating temperature: 5°C to 45°C (41°F to 113°F) (ASHRAE Classes A2 to A4 compliant) • Storage temperature (≤ 72 hours): -40°C to +65°C (-40°F to +149°F) • Long-term storage temperature (> 72 hours): 21°C to 27°C (69.8°F to 80.6°F) • Maximum temperature change rate: 20°C/h (36°F/h) <p>NOTE The highest operating temperature varies depending on the server configuration. For details, see A.2 Operating Temperature Limitations.</p>
Relative humidity (RH, non-condensing)	<ul style="list-style-type: none"> • Operating humidity: 8% to 90% • Storage humidity (≤ 72 hours): 5% to 95% • Long-term storage humidity (> 72 hours): 30% to 69% • Maximum change rate: 20%/h
Air volume	≥ 196 cubic feet per minute (CFM)

Category	Specifications
Altitude	<ul style="list-style-type: none"> ● Operating altitude ≤ 3050 m (10006.44 ft) <ul style="list-style-type: none"> - If the server complies with ASHRAE Class A2, the maximum operating temperature decreases by 1°C (1.8°F) for every increase of 300 m (984.25 ft) in altitude above 900 m (2952.76 ft). - If the server complies with ASHRAE Class A3, the maximum operating temperature decreases by 1°C (1.8°F) for every increase of 175 m (574.15 ft) in altitude above 900 m (2952.76 ft). - If the server complies with ASHRAE Class A4, the maximum operating temperature decreases by 1°C (1.8°F) for every increase of 125 m (410.10 ft) in altitude above 900 m (2952.76 ft). ● HDDs cannot be used at an altitude of over 3050 m (10006.44 ft).
Corrosive gaseous contaminant	Maximum corrosion product thickness growth rate: <ul style="list-style-type: none"> ● Copper corrosion rate test: 300 Å/month (meeting level G1 requirements of the ANSI/ISA-71.04-2013 standard on gaseous corrosion) ● Silver corrosion rate test: 200 Å/month
Particle contaminant	<ul style="list-style-type: none"> ● The equipment room environment meets the requirements of ISO 14664-1 Class 8. ● There is no explosive, conductive, magnetic, or corrosive dust in the equipment room. <p>NOTE It is recommended that the particulate pollution in the equipment room be monitored by a professional agency.</p>
Acoustic noise	The declared A-weighted sound power levels (LWAd) and declared average bystander position A-weighted sound pressure levels (LpAm) listed are measured at 23°C (73.4°F) in accordance with ISO 7779 (ECMA 74) and reported in accordance with ISO 9296 (ECMA 109). <ul style="list-style-type: none"> ● Idle: <ul style="list-style-type: none"> - LWAd: 5.3 Bels - LpAm: 38.1 dBA ● Operating: <ul style="list-style-type: none"> - LWAd: 6.3 Bels - LpAm: 48.2 dBA <p>NOTE The noise generated during operation varies depending on the server configuration, load, and ambient temperature.</p>

6.3 Physical Specifications

Table 6-3 Physical specifications

Category	Specifications
Dimensions (H x W x D)	86.1 mm x 447 mm x 748 mm (3.39 in. x 17.60 in. x 29.45 in.)
Installation space	<ul style="list-style-type: none"> ● Requirements for cabinet installation: Cabinet compliant with the International Electrotechnical Commission (IEC) 297 standard <ul style="list-style-type: none"> – Cabinet width: 482.6 mm (19 in.) – Minimum cabinet depth: 900 mm (35.43 in.) ● Requirements for guide rail installation: <ul style="list-style-type: none"> – L-shaped guide rails: apply only to Huawei cabinets. – Static rail kit: applies to cabinets with a distance of 543.5 mm to 848.5 mm (21.40 in. to 33.41 in.) between the front and rear mounting bars. – Ball bearing rail kit: applies to cabinets with a distance of 610 mm to 914 mm (24.02 in. to 35.98 in.) between the front and rear mounting bars.
Weight in full configuration	<ul style="list-style-type: none"> ● Maximum net weight: <ul style="list-style-type: none"> – Chassis with 8 x 2.5" drives: 28 kg (61.74 lb) – Chassis with 24 x 2.5" drives: 30 kg (66.15 lb) – Chassis with 25 x 2.5" drives: 31 kg (68.36 lb) ● Packaging materials: 5 kg (11.03 lb)
Power consumption	The power consumption parameters vary with hardware configurations (including the configurations complying with EU ErP). Use the Computing Product Power Calculator to obtain specific information.

7 Software and Hardware Compatibility

Use the [Computing Product Compatibility Checker](#) to obtain information about the operating systems and hardware supported.

NOTICE

- Do not use incompatible components. Otherwise, the server may fail to work properly. The technical support and warranty do not cover faults caused by incompatible components.
 - The performance of servers is closely related to application software, basic middleware software, and hardware. The slight differences of the application software, middleware basic software, and hardware may cause performance inconsistency between the application layer and test software layer.
 - If the customer has requirements on the performance of specific application software, contact Huawei sales personnel to apply for POC tests in the pre-sales phase to determine detailed software and hardware configurations.
 - If the customer has requirements on hardware performance consistency, specify the specific configuration requirements (for example, specific drive models, RAID controller cards, or firmware versions) in the pre-sales phase.
-

8 Safety Instructions

[8.1 Safety Instructions](#)

[8.2 Maintenance and Warranty](#)

8.1 Safety Instructions

General Instructions

- Comply with all local laws and regulations when installing the hardware. The safety instructions in this document are only supplemental to local laws and regulations.
- The "DANGER", "WARNING", and "CAUTION" information in this document does not represent all the safety instructions, but supplements to the safety instructions.
- To ensure safety when installing hardware, follow all safety instructions provided on the device labels and in this document.
- Only qualified personnel are allowed to perform special tasks, such as performing high-voltage operations and driving a forklift.
- Take protective measures if a Class A product is used in residential areas as it is likely to cause radio interference.

Personal Safety

- Only personnel certified or authorized by Huawei are allowed to install the hardware.
- Stop any operation that may cause personal injury or equipment damage, report the problem to a project supervisor immediately, and take protective measures.
- Do not operate the product or handle cables during thunderstorms.
- Before carrying devices, note the following points:
 - Do not carry more weight than is permitted by local laws or regulations.
 - Ensure that there are enough people to carry the devices.
- Wear clean protective gloves, ESD clothing, a protective hat, and protective shoes, as shown in [Figure 8-1](#).

Figure 8-1 Protective clothing

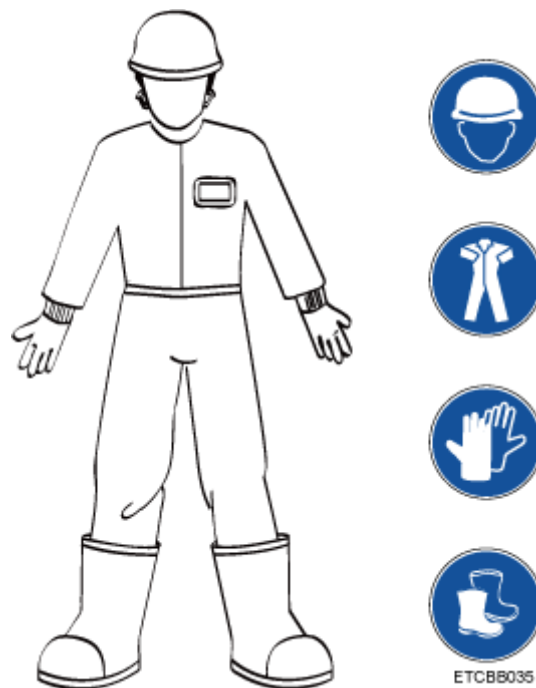

- Before touching a device, ensure that you are wearing ESD clothing and ESD gloves (or wrist strap), and remove any conductive objects (such as watches and jewelry). **Figure 8-2** shows conductive objects that must be removed before you touch a device.

Figure 8-2 Conductive objects to be removed



Figure 8-3 shows how to wear an ESD wrist strap.

- Secure the ESD wrist strap around your wrist.
- Fasten the strap buckle and ensure that the ESD wrist strap is in contact with your skin.
- Insert the ground terminal attached to the ESD wrist strap into the jack on the grounded rack or chassis.

Figure 8-3 Wearing an ESD wrist strap

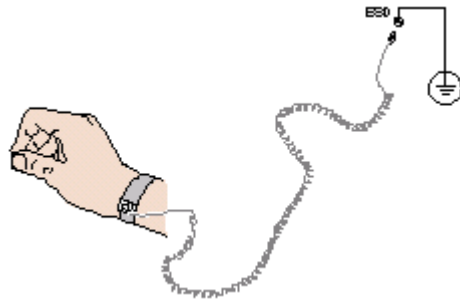

- Exercise caution when using tools that could cause personal injury.
- If the installation position of the device is above shoulder height, use a stacker to lift it. This will prevent it from falling.
- To prevent electric shock, do not touch high-voltage cables directly or indirectly. A high-voltage power supply may be powering the device.
- Properly ground a device before powering it on.
- Do not use a ladder alone. Have someone else hold the ladder steady to prevent accidents.
- To avoid damaging your eyes when installing, testing, or replacing optical cables, do not look into optical ports without eye protection.

Equipment Safety

- Use the recommended power cables at all times.
- Always use the power cables delivered with the devices.
- Wear ESD clothing and gloves before handling a device. This prevents electrostatic damage.
- When moving a device, hold the bottom of the device. Do not hold the handles of the installed modules, such as the PSUs, fan modules, drives, and the mainboard. Handle the equipment with care.
- Exercise caution when using tools that could cause personal injury.
- If the device is configured with active and standby PSUs, connect power cables of active and standby PSUs to different power distribution units (PDUs) to ensure reliable system operating.
- Properly ground a device before powering it on.

Transportation Precautions

Improper transportation may damage equipment. Contact the manufacturer for precautions before attempting transportation.

Exercise caution when transporting equipment.

- The logistics company engaged to transport the equipment must be reliable and comply with international standards for transporting electronics. Ensure that the equipment being transported is always upright. Take necessary precautions to prevent collisions, corrosion, package damage, damp conditions and pollution.
- Transport the equipment in its original packaging.

- If the original packaging is unavailable, package heavy, bulky parts (such as chassis and blades) and fragile parts (such as PCIe GPUs and SSDs) separately.

 **NOTE**

Use [Computing Product Compatibility Checker](#) to obtain information about the components supported by a node or server.

- Ensure that all devices are powered off before transportation.

Limits for the Maximum Weight Carried Per Person

 **CAUTION**

To reduce the risk of personal injury, comply with local regulations with regard to the maximum weight one person is permitted to carry.

Table 8-1 lists the maximum weight one person is permitted to carry as stipulated by a number of organizations.

Table 8-1 Maximum weight one person is permitted to carry

Organization	Weight (kg/lb)
European Committee for Standardization (CEN)	25/55.13
International Organization for Standardization (ISO)	25/55.13
National Institute for Occupational Safety and Health (NIOSH)	23/50.72
Health and Safety Executive (HSE)	25/55.13
General Administration of Quality Supervision, Inspection and Quarantine of the People's Republic of China (AQSIQ)	<ul style="list-style-type: none"> • Men: 15/33.08 • Women: 10/22.05

For more information about security instructions, see the [Huawei Server Safety Information](#).

8.2 Maintenance and Warranty

For details about the maintenance and warranty, see [Customer Support Service](#).

9 System Management

The server uses Huawei proprietary intelligent Baseboard Management Controller (iBMC) to implement remote server management. The iBMC complies with Intelligent Platform Management Interface (IPMI) 2.0 and provides highly reliable hardware monitoring and management.

Features

The iBMC supports the following features and protocols:

- KVM and text console redirection
- Remote virtual media
- IPMI
- SNMP
- Common information model (CIM)
- Redfish
- Browser-based login

Specifications

Table 9-1 iBMC specifications

Feature	Description
Management interface	Integrates with any standard management system through the following interfaces or protocols: <ul style="list-style-type: none">• IPMI• CLI• HTTPS• SNMP• Redfish
Fault detection	Detects and accurately locates faults in hardware, for example, an FRU.

Feature	Description
System watchdog	Supports BIOS POST, OS watchdog, and automatic system reset after fault timeout. Users can enable or disable these features individually.
Boot device configuration	Supports out-of-band configuration for boot devices.
Alarm management	Supports alarm management and reports alarms using the SNMP trap, Simple Mail Transfer Protocol (SMTP), and syslog service to ensure 24/7 operating.
Integrated virtual KVM	Provides remote maintenance measures and VNC service for troubleshooting.
Integrated virtual media	Virtualizes local media devices, images, USB keys, and folders into media devices on a remote server, simplifying OS installation. (The virtual DVD drive supports a maximum transmission rate of 8 MB/s.)
WebUI	Provides a user-friendly graphical user interface (GUI), simplifying user configuration and query operations.
Fault reproduction	Reproduces faults to help diagnose them quickly.
Screen snapshots and screen videos	Allows users to view screenshots and videos without login, facilitating routine preventive maintenance inspection (PMI).
Black Box	Allows users to enable or disable the black box function and download black box data.
DNS/LDAP	Supports domain management and directory services, significantly simplifying network and configuration management.
Dual-image backup	If iBMC software fails, it starts again from a backup image.
Asset management	Supports intelligent asset management.
Intelligent power management	Uses power capping to increase deployment density, and uses dynamic energy saving to reduce operating expenditure.
IPv6	Supports IPv6 to ensure sufficient IP addresses.
Network Controller Sideband Interface (NC-SI)	Supports NC-SI, allowing access the iBMC through the service network port.

10 Certifications

Country/Region	Certification	Standards
China	RoHS	SJ/T 11363-2006 SJ/T 11364-2006 GB/T 26572-2011
China	CCC	GB4943.1-2011 GB9254-2008 (Class A) GB17625.1-2012
Europe	CE	Safety: EN 60950-1:2006+A11:2009+A1:2010+A12: 2011 EN 62368-1:2014+A11:2017 EMC: EN 55032:2012/AC:2013 CISPR 32:2012 EN 55032:2015/AC:2016 CISPR 32:2015 EN 55035:2017 CISPR 35:2016 ETSI EN 300 386 V1.6.1:2012 ETSI EN 300 386 V2.1.1:2016 EN 61000-3-2:2014 EN 61000-3-3:2013 RoHS: 2011/65/EU&(EU) 2015/863, EN 50581: 2012 ErP: 2009/125/EC (ErP Directive) Commission Regulation (EU) 2019/424

Country/Region	Certification	Standards
America	FCC	FCC CFR47 Part 15:2005 Class A
Canada	IC	ICES-003:2004 Class A
Australia	C-tick	AS/NZS CISPR 22:2009
Japan	VCCI	VCCI 32-1
Saudi	SASO	IEC 60950-1: 2005 (2nd Edition) + A1:2009 EN 60950-1:2006+A11:2009+A1:2010 + A12:2011
Nigeria	SONCAP	IEC 60950-1: 2005 (2nd Edition) + A1:2009 EN 60950-1:2006+A11:2009+A1:2010 + A12:2011
Kuwait	Kucas	IEC 60950-1: 2005 (2nd Edition) + A1:2009 EN 60950-1:2006+A11:2009+A1:2010 + A12:2011

A Appendix

A.1 Product SN

The serial number (SN) on the slide-out label plate uniquely identifies a device. The SN is required when you contact Huawei technical support.

Figure A-1 SN example



Table A-1 SN description

Callout No.	Description
1	SN ID (two characters), which is 21 .
2	Material identification code (8 characters), that is, the processing code.
3	Vendor code (two characters). 10 indicates Huawei, and other values indicate outsourcing vendors.

Callout No.	Description
4	Year and month (two characters). <ul style="list-style-type: none"> The first character indicates the year. <ul style="list-style-type: none"> Digits 1 to 9 indicate years 2001 to 2009, respectively. Letters A to H indicate years 2010 to 2017, respectively. Letters J to N indicate years 2018 to 2022, respectively. Letters P to Y indicate years 2023 to 2032, respectively. <p>NOTE The years from 2010 are represented by uppercase letters excluding I, O, and Z because the three letters are similar to digits 1, 0, and 2.</p> <ul style="list-style-type: none"> The second character indicates the month. <ul style="list-style-type: none"> Digits 1 to 9 indicate January to September, respectively. Letters A to C indicate October to December, respectively.
5	Sequence number (six characters).
6	RoHS compliance (one character). Y indicates RoHS compliant.
7	Internal model, that is, product name.

A.2 Operating Temperature Limitations

Table A-2 Operating temperature limitations

Configuration	Max. 30°C (86°F)	Max. 35°C (95°F)	Max. 40°C (104°F)	Max. 45°C (113°F)
8 x 2.5" SAS/SATA drive configuration	<ul style="list-style-type: none"> All options supported 	<ul style="list-style-type: none"> All options supported 	<ul style="list-style-type: none"> Options supported: processors of up to 165 W Options not supported: GPU cards 	<ul style="list-style-type: none"> Options supported: processors of up to 140 W Options not supported: <ul style="list-style-type: none"> PCIe SSD cards NVMe drives GPU cards

Configuration	Max. 30°C (86°F)	Max. 35°C (95°F)	Max. 40°C (104°F)	Max. 45°C (113°F)
24 x 2.5" SAS/SATA drive configuration	<ul style="list-style-type: none"> • All options supported 	<ul style="list-style-type: none"> • All options supported 	<ul style="list-style-type: none"> • Options supported: processors of up to 165 W • Options not supported: <ul style="list-style-type: none"> - PCIe SSD cards - NVMe SSDs - GPU cards 	<ul style="list-style-type: none"> • Not supported
24 x 2.5" (16 x SAS/SATA + 8 x NVMe) drive configuration	<ul style="list-style-type: none"> • All options supported 	<ul style="list-style-type: none"> • All options supported 	<ul style="list-style-type: none"> • Options supported: processors of up to 140 W • Options not supported: <ul style="list-style-type: none"> • PCIe SSD cards • NVMe drives • GPU cards 	<ul style="list-style-type: none"> • Not supported
24 x 2.5" NVMe drive configuration	<ul style="list-style-type: none"> • Options supported: processors of up to 165 W 	<ul style="list-style-type: none"> • Not supported 	<ul style="list-style-type: none"> • Not supported 	<ul style="list-style-type: none"> • Not supported

Configuration	Max. 30°C (86°F)	Max. 35°C (95°F)	Max. 40°C (104°F)	Max. 45°C (113°F)
25 x 2.5" SAS/SATA drive configuration	<ul style="list-style-type: none"> All options supported 	<ul style="list-style-type: none"> All options supported 	<ul style="list-style-type: none"> Options supported: processors of up to 165 W Options not supported: PCIe SSD cards NVMe drives GPU cards 	<ul style="list-style-type: none"> Not supported

 **NOTE**

- If a single fan is faulty, the maximum operating temperature is 5°C (9°F) lower than the rated value.
- If P4/T4 GPU cards are configured:
 - All configurations except 24 x 2.5" NVMe drive configuration are supported.
 - If a P4/T4 GPU card is installed in slot 5 or 10, the maximum operating temperature supported is 30°C (86°F).
 - If a P4/T4 GPU card is installed in slot 1, the maximum operating temperature supported is 35°C (95°F).

A.3 Nameplate

Certified Model	Usage Restrictions
H24H-05	Global
H24H-05-I20	India only

A.4 RAS Features

The server supports a variety of Reliability, Availability, and Serviceability (RAS) features. You can configure these features for better RAS.

For details about how to configure RAS features, see [Huawei Server Purley Platform BIOS Parameter Reference](#).

Table A-3 RAS features

Module	Feature	Description
CPU	Corrected Machine Check Interrupt	Corrects error-triggered interruption.
DIMM	Failed DIMM Isolation	Identifies a faulty DIMM and isolates it from others before it is replaced.
	Memory Thermal Throttling	Automatically adjusts DIMM temperatures to avoid damage due to overheating.
	Rank Sparing	Allocates some memory ranks as backup ranks to prevent the system from crashing due to uncorrectable errors.
	Memory Address Parity Protection	Detects memory command and address errors.
	Memory Demand and Patrol Scrubbing	Corrects errors upon detection. If these errors are not corrected promptly, uncorrectable errors may occur.
	Memory Mirroring	Improves system reliability.
	Single Device Data Correction	Provides a single-device multi-bit error correction capability to improve memory reliability.
	Device Tagging	Degrades and rectifies DIMM device faults to improve DIMM availability.
	Data Scrambling	Optimizes data stream distribution and reduces the error possibility to improve the reliability of data streams in the memory and the capability to detect address errors.
PCIe	PCIe Advanced Error Reporting	Improves server serviceability.
UPI	Intel UPI Link Level Retry	Provides a retry mechanism upon errors to improve UPI reliability.
	Intel UPI Protocol Protection via CRC	Provides cyclic redundancy check (CRC) protection for UPI packets to improve system reliability.
System	Core Disable for Fault Resilient Boot (FRB)	Isolates a faulty CPU core during startup to improve system reliability and availability.

Module	Feature	Description
	Corrupt Data Containment Mode	Identifies the memory storage unit that contains corrupted data to minimize the impact on the running programs and improve system reliability.
	Socket disable for Fault Resilient Boot (FRB)	Isolates a faulty socket during the BIOS startup process to improve system reliability.
	Architected Error Records	With the enhanced machine check architecture (eMCA) feature, the BIOS collects error information from hardware registers in compliance with UEFI specifications, sends the error information to the OS over the APEI of the Advanced Configuration and Power Interface (ACPI), and locates the error unit, improving system availability.
	Error Injection Support	Injects errors to verify various RAS features.
	Machine Check Architecture	Provides software recovery for uncorrectable errors to improve system availability.
	eMCA: Gen2	Improves system availability.
	OOB access to MCA registers	The OBB system accesses MCA registers by using the Platform Environment Control Interface (PECI). If a fatal error occurs in the system, the out-of-band system collects onsite data to facilitate fault analysis and locating and improve system serviceability.
	BIOS Abstraction Layer for Error Handling	The BIOS processes errors and reports the error information to the OS and the server in compliance with specifications to improve system serviceability.
	BIOS-based Predictive Failure Analysis (PFA)	The BIOS provides physical unit information for DIMM errors, and the OS traces and predicts errors, and isolates error memory pages.

A.5 Sensor List

Sensor	Description	Component
Inlet Temp	Air inlet temperature	Left mounting ear
Outlet Temp	Air outlet temperature	Component in position U60 on the mainboard.
PCH Temp	PCH bridge temperature	Component in position U4014 on the mainboard.
CPU <i>N</i> Core Rem	CPU core temperature	CPU. <i>N</i> indicates the CPU number. The value ranges from 1 to 4 .
CPU <i>N</i> DTS	CPU DTS value	
Cpu <i>N</i> Margin	CPU1 Margin temperature	
CPU <i>N</i> Prochot	CPU Prochot	
CPU <i>N</i> VDDQ Temp	CPU VDDQ temperature	CPU 1: Components in positions U4333 and U4339 on the mainboard. CPU 2: Components in positions U4443 and U4447 on the mainboard. CPU 3: Components in positions U4351 and U4408 on the mainboard. CPU 4: Components in positions U4411 and U4414 on the mainboard. <i>N</i> indicates the CPU number. The value ranges from 1 to 4 .

Sensor	Description	Component
CPU/ <i>N</i> VRD Temp	CPU VRD temperature	CPU 1: Component in position U4316 on the mainboard. CPU 2: Component in position U4430 on the mainboard. CPU 3: Component in position U4370 on the mainboard. CPU 4: Component in position U4401 on the mainboard. <i>N</i> indicates the CPU number. The value ranges from 1 to 4 .
CPU/ <i>N</i> MEM Temp	CPU DIMM temperature	DIMMs of CPU/ <i>N</i> . <i>N</i> indicates the CPU number. The value ranges from 1 to 4 .
SSD Disk/ <i>N</i> Temp	SSD temperature	SSD. <i>N</i> indicates the physical drive slot number.
FAN/ <i>N</i> F Speed	Fan speed sensor	Fan module. <i>N</i> indicates the fan module number. The value ranges from 1 to 4 .
FAN/ <i>N</i> R Speed		
Power	Server input power	Total PSU power.
Power/ <i>N</i>	PSU input power	PSU. <i>N</i> indicates the PSU number. The value is 1 or 2 .
CPU/ <i>N</i> Status	CPU status	CPU. <i>N</i> indicates the CPU number. The value ranges from 1 to 4 .
CPU/ <i>N</i> Memory	DIMM status	DIMMs of CPU/ <i>N</i> . <i>N</i> indicates the DIMM number. The value ranges from 1 to 4 .
PSU/ <i>N</i> Fan Status	PSU fan status	PSU. <i>N</i> indicates the PSU number. The value is 1 or 2 .
PSU/ <i>N</i> Temp Status	PSU presence	
PSU/ <i>N</i> Status	PSU status	
Power Button	Power button status	Right mounting ear

Sensor	Description	Component
UID Button	UID button status	
DISK <i>N</i>	Drive status	Drive. <i>N</i> indicates the physical drive slot number.
FAN <i>N</i> F Presence	Fan presence	Fan module. <i>N</i> indicates the fan module number. The value ranges from 1 to 4 .
FAN <i>N</i> R Presence		
FAN <i>N</i> F Status	Fan status	
FAN <i>N</i> R Status		
RTC Battery	RTC battery status. An alarm is generated when the voltage is lower than 1 V.	CMOS battery
DIMM <i>N</i>	DIMM status	DIMM. <i>N</i> indicates the DIMM slot number.
PCH Status	PCH chip fault diagnosis health status	Component in position U4014 on the mainboard.
LCD Presence	LCD presence	LCD
LCD Status	LCD health status	
PS Redundancy	Redundancy failure due to PSU removal	PSU. <i>N</i> indicates the PSU number. The value is 1 or 2 .
PS <i>N</i> Inlet Temp	PSU air inlet temperature	
SYS 3.3V	Mainboard 3.3 V voltage	N/A <i>N</i> indicates the number of the component.
SYS 5V	Mainboard 5.0 V voltage	
SYS 12V_1	Mainboard 12.0 V voltage (the first output 12 V voltage detection for soft-start (CPU1 +PCIe Slot))	
SYS 12V_2	Mainboard 12.0 V voltage (the second output 12 V voltage detection for soft-start (CPU2 + CPU3))	

Sensor	Description	Component
SYS 12V_3	Mainboard 12.0 V voltage (the third output 12 V voltage detection for soft-start (CPU4 + fan module))	
SYS 12V_4	Mainboard 12.0 V voltage (the fourth output 12 V output voltage detection for soft-start (drive backplane module))	
SYS 12V_5	Mainboard 12.0 V voltage (the fourth output 12 V output voltage detection for soft-start (drive backplane module))	
Standby 5V	Mainboard standby 5.0 V voltage	
Standby 3.3V	Mainboard standby 3.3 V voltage	
Standby 1.8V	Mainboard standby 1.8 V voltage	
Standby 1.5V	Mainboard standby 1.5 V voltage	
CPU/VCore	1.8 V CPU voltage	
CPU/DDR VDDQ	CPU DIMM voltage	
CPU/DDR VDDQ2		
CPU/VSA	CPU VSA voltage	
CPU/VCCIO	CPU VCCIO voltage	
PCH VPVNN	PCH PVNN voltage	
PCH PRIM 1V05	PCH 1.05 V voltage	
SSD/Temp	ES3000 V3 temperature	
PwrOk Sig. Drop	Voltage dip status	
ACPI State	ACPI status	
SysFWProgress	Software process and system startup errors	
SysRestart	System restart causes	

Sensor	Description	Component
Boot Error	Boot error	
Watchdog2	Watchdog	
Mngmnt Health	Management subsystem health status	
Riser1 Card	Entity presence	
SAS Cable	Entity presence	
PCIe RAID \backslash Temp	LSI SAS3508 RAID controller card temperature	
PCIe RAID \backslash Temp	Avago SAS3004 RAID controller card temperature	
M2 Temp(PCIe \backslash M)	Maximum temperature of all M.2 drives of the RAID controller card	
PCIe Status	PCIe status	
PwrOn TimeOut	Power-on timeout	
PwrCap Status	Power capping status	
HDD Backplane	Drive backplane entity presence	
HDD BP Status	Drive backplane health status	
Port \backslash Link Down (N 1. 2. 3. 4)	Network port link status	
CPU \backslash UPI Link (N 1. 2. 3.4)	CPU UPI link fault diagnosis health status	
System Notice	Hot restart reminder and fault diagnosis program information collection	
System Error	System suspension or restart. Check the background logs	
BMC Boot Up	BMC startup events	
SEL Status	SEL full or clearing events	
Op. Log Full	Operation log full or clearing events	

Sensor	Description	Component
Sec. Log Full	Security log full or clearing events	
CPU Usage	CPU usage	
Memory Usage	Memory usage	
PCIe/N Card BBU	BBU fault or low voltage on a plug-in PCIe RAID controller card	
BMC Time Hopping	Time hopping	
NTP Sync Failed	NTP synchronization failure and recovery events	
Host Loss	System monitoring software (BMA) link loss detection	
GPU/N Temp	GPU temperature	
PCIe/N Inlet Temp	SDI card air inlet temperature	
PCIe/N Cpu Temp	SDI card CPU temperature	
PCIe/N OP Temp	PCIe card optical module temperature	
PCIe/N NIC Temp	PCIe card chip temperature	
PS/N VIN	Input voltage	

B Glossary

B.1 A-E

B

baseboard management controller (BMC)	The BMC complies with the Intelligent Platform Management Interface (IPMI). It collects, processes, and stores sensor signals, and monitors the operating status of components. The BMC provides the hardware status and alarm information about the managed objects to the upper-level management system, so that the management system can manage the objects.
--	--

E

ejector lever	A part on the panel of a device used to facilitate installation or removal of the device.
Ethernet	A baseband local area network (LAN) architecture developed by Xerox Corporation by partnering with Intel and DEC. Ethernet uses the Carrier Sense Multiple Access/Collision Detection (CSMA/CD) access method and allows data transfer over various cables at 10 Mbit/s. The Ethernet specification is the basis for the IEEE 802.3 standard.

B.2 F-J

G

Gigabit Ethernet (GE)	An extension and enhancement of traditional shared media Ethernet standards. It is compatible with 10M and 100M Ethernet and complies with IEEE 802.3z standards.
------------------------------	---

H

hot swap	Replacing or adding components without stopping or shutting down the system.
-----------------	--

B.3 K-O

K

KVM	A hardware device that provides public keyboard, video and mouse (KVM).
------------	---

B.4 P-T

P

panel	An external component (including but not limited to ejector levers, indicators, and ports) on the front or rear of the server. It seals the front and rear of the chassis to ensure optimal ventilation and electromagnetic compatibility (EMC).
Peripheral Component Interconnect Express (PCIe)	A computer bus PCI, which uses the existing PCI programming concepts and communication standards, but builds a faster serial communication system. Intel is the main sponsor for PCIe. PCIe is used only for internal interconnection. A PCI system can be transformed to a PCIe one by modifying the physical layer instead of software. PCIe delivers a faster speed and can replace almost all AGP and PCI buses.

R

redundancy	A mechanism that allows a backup device to automatically take over services from a faulty device to ensure uninterrupted running of the system.
redundant array of independent disks (RAID)	A storage technology that combines multiple physical drives into a logical unit for the purposes of data redundancy and performance improvement.

S

server	A special computer that provides services for clients over a network.
system event log (SEL)	A non-volatile area and interfaces used to store system events for later fault diagnosis and system recovery.

B.5 U-Z

U

U	A unit defined in International Electrotechnical Commission (IEC) 60297-1 to measure the height of a cabinet or chassis. 1 U = 44.45 mm
UltraPath Interconnect (UPI)	A point-to-point processor interconnect developed by Intel.

C Acronyms and Abbreviations

C.1 A-E

A

AC	alternating current
AES	Advanced Encryption Standard New Instruction Set
ARP	Address Resolution Protocol
AVX	Advanced Vector Extensions

B

BBU	backup battery unit
BIOS	Basic Input/Output System
BMC	baseboard management controller

C

CD	calendar day
CE	Conformite Europeenne
CIM	Common Information Model
CLI	command-line interface

D

DC	direct current
DDR3	Double Data Rate 3
DDR4	Double Data Rate 4
DDDC	double device data correction
DEMT	Dynamic Energy Management Technology
DIMM	dual in-line memory module
DRAM	dynamic random-access memory
DVD	digital video disc

E

ECC	error checking and correcting
ECMA	European Computer Manufacturer Association
EDB	Execute Disable Bit
EN	European Efficiency
ERP	enterprise resource planning
ETS	European Telecommunication Standards

C.2 F-J

F

FB-DIMM	Fully Buffered DIMM
FC	Fiber Channel
FCC	Federal Communications Commission
FCoE	Fibre Channel over Ethernet
FTP	File Transfer Protocol

G

GE	Gigabit Ethernet
-----------	------------------

GPIO	General Purpose Input/Output
GPU	graphics processing unit

H

HA	high availability
HDD	hard disk drive
HPC	high-performance computing
HTTP	Hypertext Transfer Protocol
HTTPS	Hypertext Transfer Protocol Secure

I

iBMC	intelligent baseboard management controller
IC	Industry Canada
ICMP	Internet Control Message Protocol
IDC	Internet Data Center
IEC	International Electrotechnical Commission
IEEE	Institute of Electrical and Electronics Engineers
IGMP	Internet Group Message Protocol
IOPS	input/output operations per second
IP	Internet Protocol
IPC	intelligent power capability
IPMB	Intelligent Platform Management Bus
IPMI	Intelligent Platform Management Interface

C.3 K-O

K

KVM	keyboard, video, and mouse
------------	----------------------------

L

LC	Lucent connector
LRDIMM	load-reduced dual in-line memory module
LED	light emitting diode
LOM	LAN on motherboard

M

MAC	media access control
MMC	module management controller

N

NBD	next business day
NC-SI	Network Controller Sideband Interface

C.4 P-T**P**

PCIe	Peripheral Component Interconnect Express
PDU	power distribution unit
PHY	physical layer
PMBUS	power management bus
POK	power OK
PWM	pulse-width modulation
PXE	Preboot Execution Environment

Q

QPI	Quick Path Interconnect
------------	-------------------------

R

RAID	redundant array of independent disks
RAS	reliability, availability and serviceability
RDIMM	registered dual in-line memory module
REACH	Registration Evaluation and Authorization of Chemicals
RJ45	registered jack 45
RoHS	Restriction of the Use of Certain Hazardous Substances in Electrical and Electronic Equipment

S

SAS	Serial Attached Small Computer System Interface
SATA	Serial Advanced Technology Attachment
SCM	supply chain management
SDDC	single device data correction
SERDES	serializer/deserializer
SGMII	serial gigabit media independent interface
SMI	serial management interface
SMTP	Simple Mail Transfer Protocol
SNMP	Simple Network Management Protocol
SOL	serial over LAN
SONCAP	Standards Organization of Nigeria-Conformity Assessment Program
SSD	solid-state drive
SSE	Streaming SIMD Extensions

T

TACH	tachometer signal
TBT	Turbo Boost Technology
TCG	Trusted Computing Group
TCM	trusted cryptography module
TCO	total cost of ownership

TDP	thermal design power
TELNET	Telecommunication Network Protocol
TET	Trusted Execution Technology
TFM	TransFlash module
TFTP	Trivial File Transfer Protocol
TOE	TCP offload engine
TPM	trusted platform module

C.5 U-Z

U

UDIMM	unbuffered dual in-line memory module
UEFI	Unified Extensible Firmware Interface
UID	unit identification light
UL	Underwriter Laboratories Inc.
USB	Universal Serial Bus

V

VCCI	Voluntary Control Council for Interference by Information Technology Equipment
VGA	Video Graphics Array
VLAN	virtual local area network
VRD	voltage regulator-down

W

WEEE	waste electrical and electronic equipment
WSMAN	Web Service Management