

E3NX-FA

Smart Fiber Amplifier Units

EtherCAT



High performance Fiber amplifiers
with unmatched stability
and resolution

A new level of Fiber sensing performance

N-Smart

Presence

Detection

Measurement

Simpler and More Dependable

The N-Smart Lineup of Next-generation Fiber Sensors and Laser Sensors will quickly solve your problems and therefore increase equipment operation rates and minimize downtime with optimum cost performance.

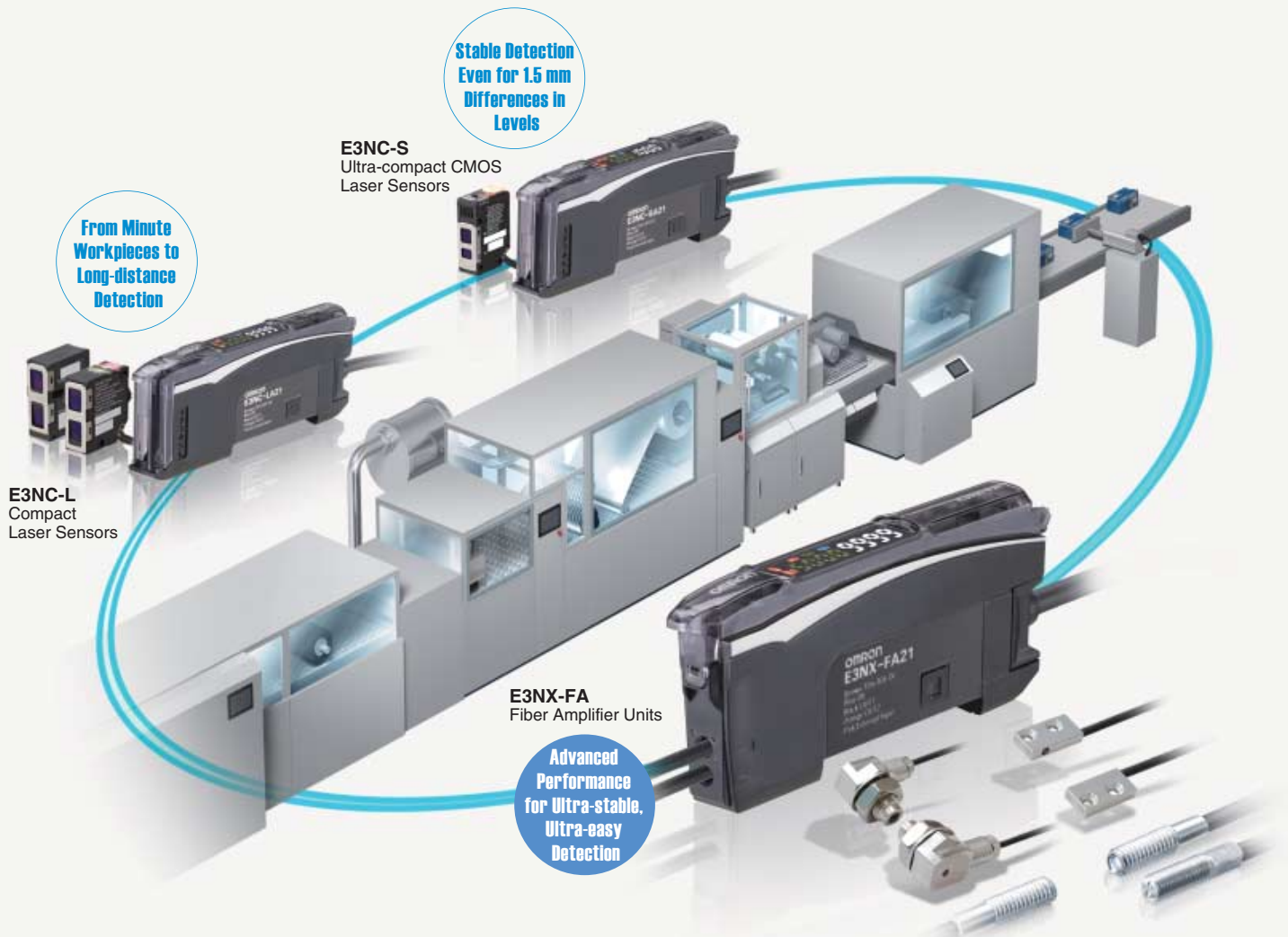

Ultra-stable

Advanced Basic Performance

Expanded Application Response Capabilities

We've expanded the range of applications in which stable detection is possible by improving two basic performance specifications, the sensing distance and the minimum sensing object.

Best Basic Performance in the World*1

1.5 Times the Sensing Distance*2

6 m

For E32-LT11 Fiber Unit with a fiber length of 3.5 m

1/10th the Minimum Sensing Object*2

0.3 μm dia.

Typical example of actual measurements with E32-D11R Fiber Unit

Improved Basic Performance

N-Smart Technology

The "GIGA RAY 2S" high-efficiency coupling element achieves a clear signal and wide dynamic range and it is joined by the low-noise "Smart Noise Reduction" light reception algorithm and the high-speed, high-precision "N-Core".

These three technologies improve the basic performance as is evident in the high signal-to-noise ratio (the backbone of stable detection) that is 2.5 times that of conventional models*2.

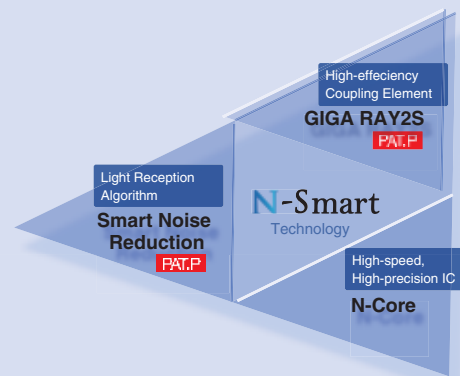

Industry First*1

Highly Visible White Display Characters

Clearly Readable Even from a Distance

The high-contrast white on black display increases display visibility.

The values are clearly readable even from a distance.

The display also lowers the load on users' eyes.



*1. OMRON Investigation in November 2012

*2. Compared to E3X-HD.

Ultra-easy

Advanced Smart Tuning

Achieve Easy Detection in Many Applications

Consistent Settings for All Users **Smart Tuning Settings**

Just press the **S**TUNE button once with a workpiece and once without a workpiece to automatically set the optimum incident level and threshold.

Consistent settings are achieved for all users with this ultra-easy procedure.



Automatic Setting of Optimum Values

Threshold + Incident Level

5000 9999

Set to the intermediate value between the incident levels with and without a workpiece.

Incident level adjustment with and without a workpiece

Dynamic Range Increased by a Factor of 40,000

Automatic Adjustment to Optimum Incident Level **Dynamic Range Increased by a Factor of 40,000**

The dynamic range has been increased by a factor of 40,000.

The incident level is optimized to enable stable detection even for saturated or insufficient incident levels.



Excessive Incident Level
▶ Incident light reduced.

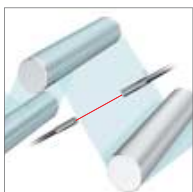

Saturation Distance: **1.2 mm**

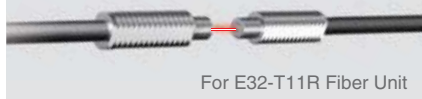

Insufficient Incident Level
▶ Incident light increased.



Point



30μs*1

Optimum Settings Achieved Even in Super-high-speed Mode

More Dependable Detection of High-speed Workpieces

The N-Core enables incident light adjustment even in 30 μs in the Super-high-speed Mode. This enables more-stable detection of faster workpieces than for conventional models.*2

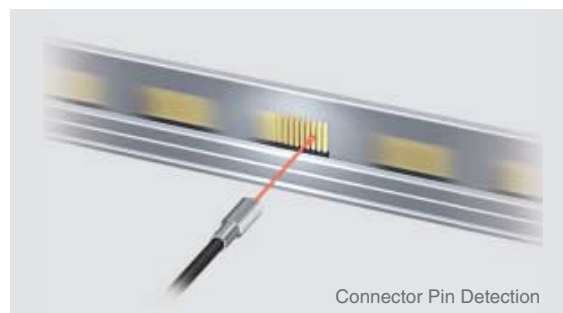

*1. Model with 1 output: 30 μs, model with 2 outputs: 32 μs. *2. E3X-HD.

Ultra-reliable

Powerful Support for Manual Settings

Easy, Dependable Manual Settings with Two Types of Visual Information

What detection mode is best? Where should the threshold be? Is stable detection really possible?

Visual status information provides the answers to these and other questions.

Visual Displays of the Passing Time and Difference in Incident Levels

Solution Viewer PAT.P

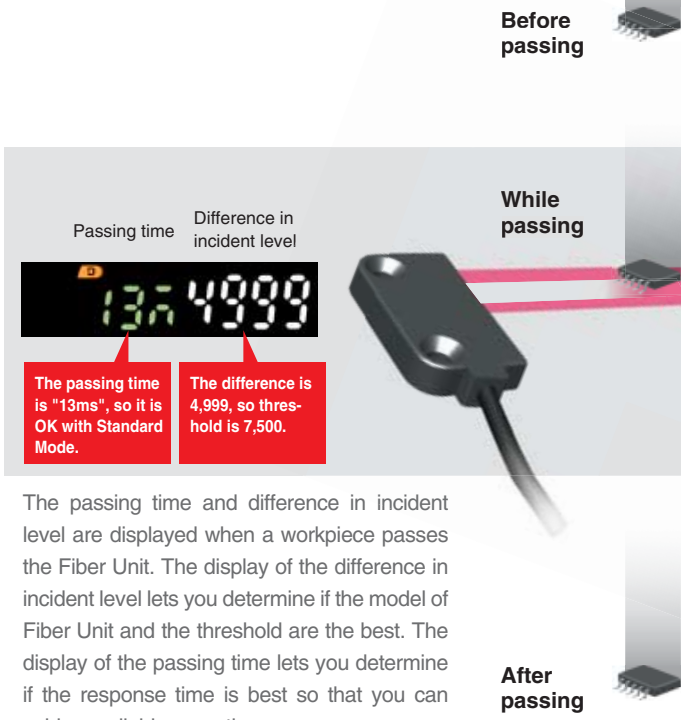

The passing time and difference in incident level are displayed when a workpiece passes the Fiber Unit. The display of the difference in incident level lets you determine if the model of Fiber Unit and the threshold are the best. The display of the passing time lets you determine if the response time is best so that you can achieve reliable operation.

Short-cut Startup in Detection Mode



Simultaneously press the **MODE** and **L/D** Keys.

Visual Information for Fast Workpieces
Change Finder PAT.P

Conventional model

E3NX-FA



Display could not keep up with the workpiece speed.



Displayed for 500 ms.

The display value for the passing workpiece can be read.



The incident level is displayed for 500 ms after the workpiece passes the Fiber Unit so that you can check the detection status even for workpieces that travel too quickly to see the changes in the display value. This lets you set a reliable threshold.

Point

Advanced DPC PAT.P
(Dynamic Power Control)

Predictive Maintenance to Reduce Downtime





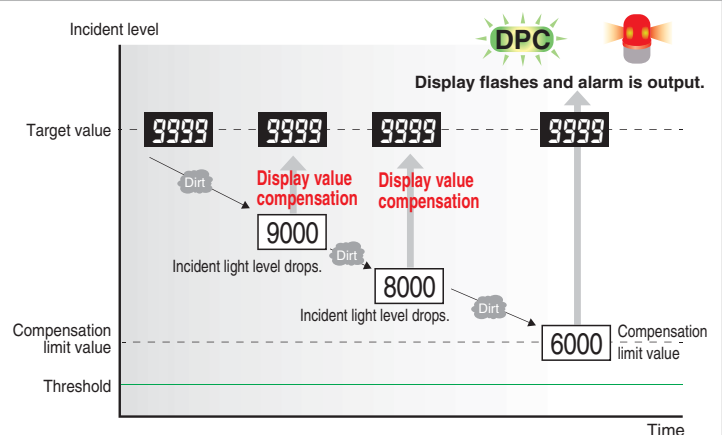

An alarm output* has been added to the DPC that automatically compensates differences in the incident level. A maintenance signal is output when the incident level drops due to dirt or vibration for use in predictive maintenance. (We recommend DPC for through-beam or retro-reflective models.)

*An alarm output is supported only on models with two outputs.



Ordering Information

Fiber Amplifier Units

Type	Connecting method	Appearance	Inputs/outputs	Model	
				NPN output	PNP output
Standard models	Pre-wired (2 m)		1 output	E3NX-FA11 2M	E3NX-FA41 2M
	Wire-saving Connector		1 output	E3NX-FA6	E3NX-FA8
Advanced models	Pre-wired (2 m)		2 outputs + 1 input	E3NX-FA21 2M	E3NX-FA51 2M
	Wire-saving Connector		1 output + 1 input	E3NX-FA7	E3NX-FA9
			2 outputs	E3NX-FA7TW	E3NX-FA9TW
	M8 Connector		1 output + 1 input	E3NX-FA24	E3NX-FA54
			2 outputs	—	E3NX-FA54TW
Model for Sensor Communications Unit *	Connector for Sensor Communications Unit		—	E3NX-FA0	

* A Sensor Communications Unit is required if you want to use the Amplifier Unit on a network.

Accessories (Sold Separately)

Wire-saving Connectors (Required for models for Wire-saving Connectors.)

Connectors are not provided with the Fiber Amplifier Unit and must be ordered separately. *Protective stickers are attached. Cable length is 2m.

Type	No. of conductors	Model	Applicable Fiber Amplifier Units
Master Connector	4	E3X-CN21	E3NX-FA7 E3NX-FA7TW
Slave Connector	2	E3X-CN22	E3NX-FA9 E3NX-FA9TW
Master Connector	3	E3X-CN11	E3NX-FA6 E3NX-FA8
Slave Connector	1	E3X-CN12	



There is no distinction between master and slave on the Amplifier Unit. Purchase the Connector and Amplifier Unit together according to the application.

Sensor I/O Connectors (Required for models for M8 Connectors.)

Connectors are not provided with the Fiber Amplifier Unit and must be ordered separately.

Size	Appearance	Cable type	Model
M8	Straight	2m	XS3F-M421-402-A
		5m	XS3F-M421-405-A
	L-shaped	2m	XS3F-M422-402-A
		5m	XS3F-M422-405-A



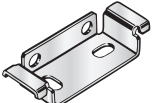

Mounting Bracket

A Mounting Bracket is not provided with the Fiber Amplifier Unit and must be ordered separately as required.

Appearance	Model	Quantity
	E39-L143	1

Related Products

Sensor Communications Units

Type	Appearance	Model
Sensor Communications Unit for EtherCAT		E3NW-ECT
Sensor Communications Unit for CompoNet *1		E3NW-CRT
Sensor Communications Unit for CC-Link *1		E3NW-CCL
Distributed Sensor Unit *2		E3NW-DS

*1. Refer to your OMRON website for details.

*2. The Distributed Sensor Unit can be connected to any of the Sensor Communications Units.

Ratings and Specifications



Item	Type	Standard models		Advanced models					Model for Sensor Communications Unit
	NPN output	E3NX-FA11	E3NX-FA6	E3NX-FA21	E3NX-FA7	E3NX-FA7TW	E3NX-FA24	---	E3NX-FA0
	PNP output	E3NX-FA41	E3NX-FA8	E3NX-FA51	E3NX-FA9	E3NX-FA9TW	E3NX-FA54	E3NX-FA54TW	
Connecting method	Pre-wired	Wire-saving Connector	Pre-wired	Wire-saving Connector		M8 Connector		Connector for Sensor Communications Unit	
Inputs/outputs	Outputs	1 output		2 outputs	1 output	2 outputs	1 output	2 outputs	—*3
	External inputs	—		1 input	1 input	—	1 input	—	
Light source (wavelength)		Red, 4-element LED (625 nm)							
Power supply voltage		10 to 30 VDC, including 10% ripple (p-p)							
Power consumption *1		At Power Supply Voltage of 24 VDC Standard Model or Model for Sensor Communications Unit: Normal mode: 960 mW max. (Current consumption: 40 mA max.), Power saving eco mode: 840 mW max. (Current consumption: 35 mA max.) Advanced Model: Normal mode: 1,080 mW max. (Current consumption: 45 mA max.), Power saving eco mode: 930 mW max. (Current consumption: 40 mA max.)							
Control outputs		Load power supply voltage: 30 VDC max., open-collector output Load current: Groups of 1 to 3 Amplifire Units: 100 mA max., Groups of 4 to 30 Amplifire Units: 20 mA max. (Residual voltage: At load current of less than 10 mA: 1 V max.) At load current of 10 to 100 mA: 2 V max.) OFF current: 0.1 mA max.							—
Response time	Super-high-speed mode (SHS) *2	Operate or reset for model with 1 output: 30 μs, with 2 outputs: 32 μs							
	High-speed mode (HS)	Operate or reset: 250 μs							
	Standard mode (Std)	Operate or reset: 1 ms							
	Giga-power mode (GI GA)	Operate or reset: 16 ms							
No. of Units for mutual interference prevention	Super-high-speed mode (SHS) *2	0							
	High-speed mode (HS)	10							
	Standard mode (Std)	10							
	Giga-power mode (GI GA)	10							
Functions		Auto power control (APC), dynamic power control (DPC), timer, zero reset, resetting settings, eco mode, bank switching, power tuning, and hysteresis width							
Maximum connectable Units		30							

- *3. At Power Supply Voltage of 10 to 30 VDC
 Standard Model or Model for Sensor Communications Unit:
 Normal mode: 1,080 mW max. (Current consumption: 36 mA max. at 30 VDC, 108 mA max. at 10 VDC)
 Power saving eco mode: 930 mW max. (Current consumption: 31 mA max. at 30 VDC, 93 mA max. at 10 VDC)
 Advanced Model:
 Normal mode: 1,230 mW max. (Current consumption: 41 mA max. at 30 VDC, 123 mA max. at 10 VDC)
 Power saving eco mode: 1,050 mW max. (Current consumption: 35 mA max. at 30 VDC, 105 mA max. at 10 VDC)
- *4. The mutual interference prevention function is disabled if the detection mode is set to super-high-speed mode.
- *5. Two sensor outputs are allocated in the programmable logic controller PLC I/O table.
 PLC operation via Communications Unit enables reading detected values and changing settings.

* For details, refer to the Fiber Sensor Best Selection Catalog (Cat No. E418).

Dimensions

(Unit: mm)
 Tolerance class IT16 applies to dimensions in this data sheet unless otherwise specified.

Pre-wired Amplifier Units

E3NX-FA11
 E3NX-FA21
 E3NX-FA41
 E3NX-FA51

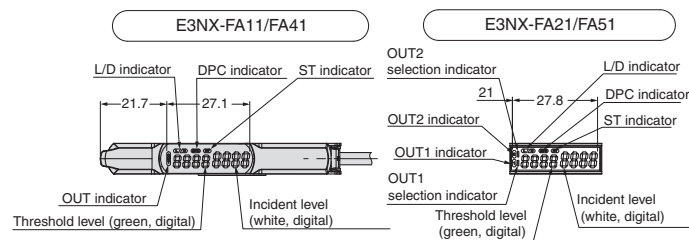

*Cable Specifications

Model	Outer diameter	No. of conductors	Others
E3NX-FA11	4.0 dia.	3	Conductor cross-section: 0.2 mm ² Insulator dia.: 0.9 mm
E3NX-FA41	4.0 dia.	3	
E3NX-FA21	4.0 dia.	5	Standard length: 2 m Minimum bending radius: 12 mm
E3NX-FA51	4.0 dia.	5	

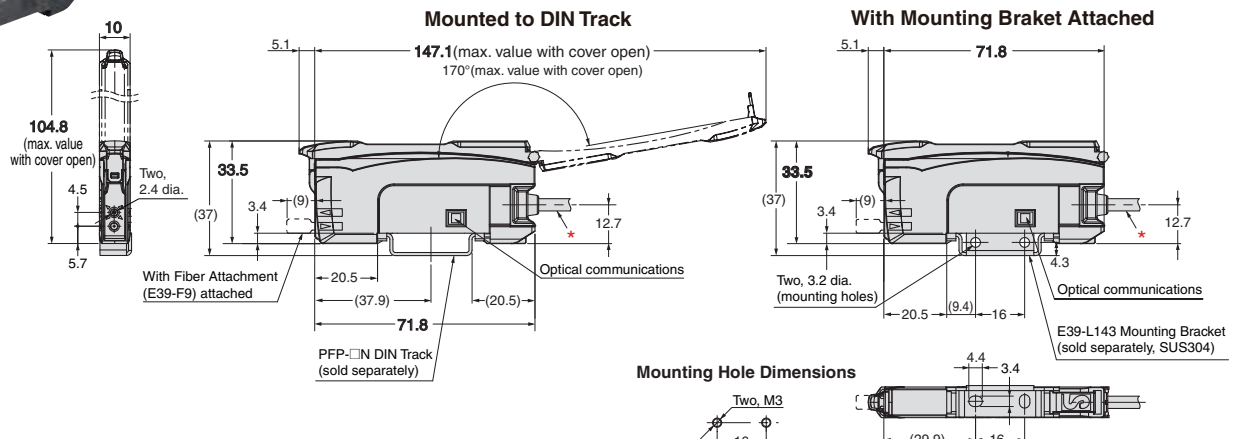

* Refer to the Fiber Sensor Best Selection Catalog (Cat No. E418) for the dimensions of models with wire-saving connectors, dimensions of models for Sensor Communications Units, and other dimensions.

The N-Smart Lineup

E3NX-FA
Fiber Amplifier Units

N-Smart Amplifier Units
Easy application with consistent operating procedures.

E3NC-S
Ultra-compact CMOS
Laser Sensors
Cat. No. E427

E3NC-L
Compact
Laser Sensors
Cat. No. E427

E3NW
Sensor
Communications Units
Cat. No. E428

N-Smart
Presence / Detection / Measurement

Applications with Many Sensors:
More convenience and even lower costs with a network.

EtherCAT

Fiber Sensor Best Selection Catalog

Refer to the Fiber Sensor Best Selection Catalog for information on Fiber Units and detailed information on the E3NX-FA.



Cat. No. E418

EtherCAT® is a registered trademark and patented technology, licensed by Beckhoff Automation GmbH, Germany.

OMRON Corporation Industrial Automation Company
Tokyo, JAPAN

Contact: www.ia.omron.com

Regional Headquarters

OMRON EUROPE B.V.
Sensor Business Unit
Carl-Benz-Str. 4, D-71154 Nufringen, Germany
Tel: (49) 7032-811-0/Fax: (49) 7032-811-199

OMRON ELECTRONICS LLC
One Commerce Drive Schaumburg,
IL 60173-5302 U.S.A.
Tel: (1) 847-843-7900/Fax: (1) 847-843-7787

OMRON ASIA PACIFIC PTE. LTD.
No. 438A Alexandra Road # 05-05/08 (Lobby 2),
Alexandra Technopark,
Singapore 119967
Tel: (65) 6835-3011/Fax: (65) 6835-2711

OMRON (CHINA) CO., LTD.
Room 2211, Bank of China Tower,
200 Yin Cheng Zhong Road,
PuDong New Area, Shanghai, 200120, China
Tel: (86) 21-5037-2222/Fax: (86) 21-5037-2200

Authorized Distributor:

© OMRON Corporation 2012 All Rights Reserved.
In the interest of product improvement,
specifications are subject to change without notice.

Cat. No. E426-E1-01

Printed in Japan
1212 (1212) (W)