

Vision Sensor FH/FZ5 Series Vision System

User's Manual for Communications Settings

FH-1□□□
FH-1□□□-□□
FH-3□□□
FH-3□□□-□□
FH-L□□□
FH-L□□□-□□

FZ5-6□□
FZ5-6□□-□□
FZ5-8□□
FZ5-8□□-□□
FZ5-11□□
FZ5-11□□-□□
FZ5-12□□
FZ5-12□□-□□
FZ5-L35□
FZ5-L35□-□□



Introduction

Thank you for purchasing the FH/FZ5.

This manual provides information regarding functions, performance and operating methods that are required for using the FH/FZ5.

When using the FH/FZ5, be sure to observe the following:

- The FH/FZ5 must be operated by personnel knowledgeable in electrical engineering.
- To ensure correct use, please read this manual thoroughly to deepen your understanding of the product.
- Please keep this manual in a safe place so that it can be referred to whenever necessary.

NOTE

- All rights reserved. No part of this publication may be reproduced, stored in a retrieval system, or transmitted, in any form, or by any means, mechanical, electronic, photocopying, recording, or otherwise, without the prior written permission of OMRON.
- No patent liability is assumed with respect to the use of the information contained herein. Moreover, because OMRON is constantly striving to improve its high-quality products, the information contained in this manual is subject to change without notice. Every precaution has been taken in the preparation of this manual. Nevertheless, OMRON assumes no responsibility for errors or omissions. Neither is any liability assumed for damages resulting from the use of the information contained in this publication.

Trademarks

- Sysmac and SYSMAC are trademarks or registered trademarks of OMRON Corporation in Japan and other countries for OMRON factory automation products.
- This software is based in part on the work of the Independent JPEG Group.
- Microsoft, Windows, Windows Vista, Excel, and Visual Basic are either registered trademarks or trademarks of Microsoft Corporation in the United States and other countries.
- EtherCAT® is registered trademark and patented technology, licensed by Beckhoff Automation GmbH, Germany.
- ODVA, CIP, CompoNet, DeviceNet, and EtherNet/IP are trademarks of ODVA.
- The SD and SDHC logos are trademarks of SD-3C, LLC. 
- MELSEC is a registered trademarks of Mitsubishi Electric Corporation.

Other company names and product names in this document are the trademarks or registered trademarks of their respective companies.

Copyrights

Microsoft product screen shots reprinted with permission from Microsoft Corporation.

FH/FZ5 Manual Configuration

The following table gives the manual configuration of the FH/FZ5.

Name of Manual	Cat. No.	Model	Purpose	Contents
Vision System FH Instruction Sheet	9607479-9	FH-1□□□ FH-1□□□-□□ FH-3□□□ FH-3□□□-□□	To confirm the safety and usage precautions of the Vision System FH series Sensor Controller.	Describes the definitions of basic terms, meaning of signal words, and precautions for correct use of FH series in the manual.
Vision System FH-L Instruction Sheet	9606631-1	FH-L□□□ FH-L□□□-□□	To confirm the safety and usage precautions of the Vision System FH-Lite series Sensor Controller.	Describes the definitions of basic terms, meaning of signal words, and precautions for correct use of FH-L series in the manual.
Vision System FZ5 Instruction Sheet	9524422-4	FZ5-6□□ FZ5-6□□-□□ FZ5-11□□ FZ5-11□□-□□	To confirm the setup procedures, safety and usage precautions of the Vision System FZ5-600, FZ5-1100 series Sensor Controller, including I/O setup and wiring.	Describes the definitions of basic terms, meaning of signal words, and precautions for correct use of FZ5-600, FZ5-1100 series in the manual.
Vision System FZ5 Instruction Sheet	9308317-7	FZ5-8□□ FZ5-8□□-□□ FZ5-12□□ FZ5-12□□-□□	To confirm the setup procedures, safety and usage precautions of the Vision System FZ5-800, FZ5-1200 series Sensor Controller, including I/O setup and wiring.	Describes the definitions of basic terms, meaning of signal words, and precautions for correct use of FZ5-800, FZ5-1200 series in the manual.
Vision System FZ5-L Instruction Sheet	9910002-2	FZ5-L35□ FZ5-L35□-□□	To confirm the setup procedures, safety and usage precautions of the Vision System FZ5-L Series Sensor Controller, including I/O setup and wiring.	Describes the definitions of basic terms, meaning of signal words, and precautions for correct use of FZ5-L series in the manual.

Name of Manual	Cat. No.	Model	Purpose	Contents
Vision System FH/FZ5 Series User's Manual	Z365		When User want to know how to setup the Sensor Controller of the Vision System FH/FZ5 series.	Describes the soft functions, setup, and operations to use Sensor Controller of the Vision System FH/FZ5 series.
Vision System FH/FZ5 series Hardware Setup Manual	Z366	FH-1□□□ FH-1□□□-□□ FH-3□□□ FH-3□□□-□□ FH-L□□□ FH-L□□□-□□	When User want to know about the Hard-ware specifications or to setup the Sensor Controller of the Vision System FH/FZ5 series.	Describes FH/FZ5 series specifications, dimensions, part names, I/O information, installation information, and wiring information.
Vision System FH/FZ5 series Macro Customize Functions Programming Manual	Z367	FZ5-L35□ FZ5-L35□-□□ FZ5-6□□	When User operate or programming using Macro Customize functions.	Describes the functions, settings, and operations for using Macro Customize function of the FH/FH5-series.
Vision System FH/FZ5 series Processing Item Function Reference Manual	Z341	FZ5-6□□-□□ FZ5-8□□ FZ5-8□□-□□ FZ5-11□□	When User confirm the details of each processing items at the create the measurement flow or operate it.	Describes the software functions, settings, and operations for using FH/FH5-series.
Vision System FH/FZ5 Series User's Manual for Communications Settings	Z342	FZ5-11□□-□□ FZ5-12□□ FZ5-12□□-□□	When User confirm the setting of communication functions.	Describes the functions, settings, and communications methods for communicating between FH/FH5 series. The following communication protocol are described. Parallel, PLC Link, EtherNet/IP, EtherCAT, and Non-procedure
Vision System FH Series Operation Manual for Sysmac Studio	Z343	FH-1□□□ FH-1□□□-□□ FH-3□□□ FH-3□□□-□□	When User connect to NJ series via EtherCAT communication.	Describes the operating procedures for setting up and operating FH series Vision Sensors from the Sysmac Studio FH Tools.

Conventions Used in This Manual

Symbols

The symbols used in this manual have the following meanings.

IMPORTANT

Indicates relevant operational precautions that must be followed.

Note

Indicates operation-related suggestions from OMRON.

Use of Quotation Marks and Brackets

In this manual, menus and other items are indicated as follows.

[] Menu Indicates the menu names or processing items shown in the menu bar.

“ ” Item name Indicates the item names displayed on the screen.

Terms and Conditions Agreement

Warranty, Limitations of Liability

● Warranties

Exclusive Warranty

Omron's exclusive warranty is that the Products will be free from defects in materials and workmanship for a period of twelve months from the date of sale by Omron (or such other period expressed in writing by Omron). Omron disclaims all other warranties, express or implied.

Limitations

OMRON MAKES NO WARRANTY OR REPRESENTATION, EXPRESS OR IMPLIED, ABOUT NON-INFRINGEMENT, MERCHANTABILITY OR FITNESS FOR A PARTICULAR PURPOSE OF THE PRODUCTS. BUYER ACKNOWLEDGES THAT IT ALONE HAS DETERMINED THAT THE PRODUCTS WILL SUITABLY MEET THE REQUIREMENTS OF THEIR INTENDED USE.

Omron further disclaims all warranties and responsibility of any type for claims or expenses based on infringement by the Products or otherwise of any intellectual property right.

Buyer Remedy

Omron's sole obligation hereunder shall be, at Omron's election, to (i) replace (in the form originally shipped with Buyer responsible for labor charges for removal or replacement thereof) the non-complying Product, (ii) repair the non-complying Product, or (iii) repay or credit Buyer an amount equal to the purchase price of the non-complying Product; provided that in no event shall Omron be responsible for warranty, repair, indemnity or any other claims or expenses regarding the Products unless Omron's analysis confirms that the Products were properly handled, stored, installed and maintained and not subject to contamination, abuse, misuse or inappropriate modification. Return of any Products by Buyer must be approved in writing by Omron before shipment. Omron Companies shall not be liable for the suitability or unsuitability or the results from the use of Products in combination with any electrical or electronic components, circuits, system assemblies or any other materials or substances or environments. Any advice, recommendations or information given orally or in writing, are not to be construed as an amendment or addition to the above warranty.

See <http://www.omron.com/global/> or contact your Omron representative for published information.

● Limitation on Liability; Etc

OMRON COMPANIES SHALL NOT BE LIABLE FOR SPECIAL, INDIRECT, INCIDENTAL, OR CONSEQUENTIAL DAMAGES, LOSS OF PROFITS OR PRODUCTION OR COMMERCIAL LOSS IN ANY WAY CONNECTED WITH THE PRODUCTS, WHETHER SUCH CLAIM IS BASED IN CONTRACT, WARRANTY, NEGLIGENCE OR STRICT LIABILITY.

Further, in no event shall liability of Omron Companies exceed the individual price of the Product on which liability is asserted.

Application Considerations Warranties

Suitability of Use

Omron Companies shall not be responsible for conformity with any standards, codes or regulations which apply to the combination of the Product in the Buyer's application or use of the Product. At Buyer's request, Omron will provide applicable third party certification documents identifying ratings and limitations of use which apply to the Product. This information by itself is not sufficient for a complete determination of the suitability of the Product in combination with the end product, machine, system, or other application or use. Buyer shall be solely responsible for determining appropriateness of the particular Product with respect to Buyer's application, product or system. Buyer shall take application responsibility in all cases.

NEVER USE THE PRODUCT FOR AN APPLICATION INVOLVING SERIOUS RISK TO LIFE OR PROPERTY WITHOUT ENSURING THAT THE SYSTEM AS A WHOLE HAS BEEN DESIGNED TO ADDRESS THE RISKS, AND THAT THE OMRON PRODUCT(S) IS PROPERLY RATED AND INSTALLED FOR THE INTENDED USE WITHIN THE OVERALL EQUIPMENT OR SYSTEM.

Programmable Products

Omron Companies shall not be responsible for the user's programming of a programmable Product, or any consequence thereof.

Disclaimers

Performance Data

Data presented in Omron Company websites, catalogs and other materials is provided as a guide for the user in determining suitability and does not constitute a warranty. It may represent the result of Omron's test conditions, and the user must correlate it to actual application requirements. Actual performance is subject to the Omron's Warranty and Limitations of Liability.

Change in Specifications

Product specifications and accessories may be changed at any time based on improvements and other reasons. It is our practice to change part numbers when published ratings or features are changed, or when significant construction changes are made. However, some specifications of the Product may be changed without any notice. When in doubt, special part numbers may be assigned to fix or establish key specifications for your application. Please consult with your Omron's representative at any time to confirm actual specifications of purchased Product.

Errors and Omissions

Information presented by Omron Companies has been checked and is believed to be accurate; however, no responsibility is assumed for clerical, typographical or proofreading errors or omissions.

Safety Precautions

For details on Safety Precautions, refer to *Safety Precautions* in the *Vision System FH/FZ5 Series User's Manual* (Cat. No. Z365).

Precautions for Safe Use

For details on Precautions for Safe Use, refer to *Precautions for Safe Use* in the *Vision System FH/FZ5 Series User's Manual* (Cat. No. Z365).

Precautions for Correct Use

For details on Precautions for Correct Use, refer to *Precautions for Correct Use* in the *Vision System FH/FZ5 Series User's Manual* (Cat. No. Z365).

Regulations and Standards

For details on Regulations and Standards, refer to *Regulations and Standards* in the *Vision System FH/FZ5 Series User's Manual* (Cat. No. Z365).

MEMO

Contents

FH/FZ5 Manual Configuration	1
Conventions Used in This Manual	2
Terms and Conditions Agreement	3
Safety Precautions	5
Precautions for Safe Use	5
Precautions for Correct Use	5
Regulations and Standards	5
1. Overview	11
Introduction	12
Confirming the System Configuration	13
System Configuration	13
Communicating with an External Device	14
Basic Control Operations of the Sensor Controller	14
Communication between the Sensor Controller and an External Device	16
Control Methods for the Sensor Controller	17
Communication Protocols for Communication with the Sensor Controller	19
Saving Sensor Controller Data to an External Device	20
Control Methods Using an External Device	22
Control with Control Signals and Status Signals	22
Command/Response Method	25
Data Output after Measurements	26
Setting Procedures for Communications	35
Communications Setup Procedures	35
Communications Protocols and Communications Modules	36
Differences in Specifications Based on the Communications Protocol	37
List of Supported Signals by Communications Protocol	37
Restrictions when Using Different Communication Protocols Simultaneously	39
Communication protocol restrictions by operation mode	39
Models That Are Compatible with the Communications Protocols	40
2. Methods for Connecting and Communicating with External Devices	43
EtherCAT Connections (FH-1000 series/FH-3000 series only)	44
Introduction to EtherCAT	44
Structure of CAN Application Protocol over EtherCAT (CoE)	47
EtherCAT Slave Information Files (ESI Files)	48
Transitions of Communications States	49
Process Data Objects (PDOs)	50
Service Data Objects (SDOs)	53
Communications between an EtherCAT Master and Slaves	54
FH-series Vision Sensor Communications Method When Connected to EtherCAT	55
Communications Settings	60
Communications Module Settings (Startup Settings)	62
Communications Specifications Settings	63
Output Data Settings (Processing Item Registration)	66
EtherCAT Network Configuration Settings	69
Communications Test	70
I/O Ports by Area (PDO Mapping) and Memory Assignments	71
I/O Signals	76

Measurement Results That You Can Output with Fieldbus Data Output	80
Command List	81
Measurement Trigger Input	84
Command Response Processing	85
Data Output	88
Time Charts	90
EtherCAT Troubleshooting	94
Sysmac Error Status	96
Sysmac Device Features	110
Object Dictionary	112
Communicating with PLC Link	162
Communications Processing Flow	162
Communications Setup Procedures	164
Communications Module Settings (Startup Settings)	164
Communications Specifications Settings	166
Output Data Settings (Processing Item Registration)	184
Testing Communications	189
Memory Allocation	192
I/O Signals	195
Output Items	198
Command List	199
Command Response Processing	202
Data Output	205
Time Charts	207
PLC Link Troubleshooting	210
Communicating with EtherNet/IP	213
Introduction to EtherNet/IP	213
Data Exchange with EtherNet/IP	214
EtherNet/IP Communications	217
Communications Processing Flow	218
Communications Setup Procedures	220
Communications Module Settings (Startup Settings)	221
Communications Specifications Settings	222
Tag Data Link Setting Methods	228
Output Data Settings (Processing Item Registration)	232
Testing Communications	236
Memory Allocation	238
I/O Signals	247
Output Items	250
Command List	251
Command Response Processing	255
Data Output	258
Time Charts	260
Communicating with the Sensor Controller with EtherNet/IP Message Communications	264
Command Setting Example	267
EtherNet/IP Troubleshooting	267
Non-procedure Communications	269
Communications Processing Flow	269
Communications Setup Procedures	270
Communications Module Settings (Startup Settings)	271
Communications Specifications Settings	272
Output Data Settings (Processing Item Registration)	279

Testing Communications	285
Output Items	288
Command Formats	289
Command List	292
Output Format	296
Non-procedure Communications Troubleshooting	298
Parallel Communications	299
Communications Processing Flow	299
Communications Setup Procedures	301
Communications Module Settings (Startup Settings)	302
Communications Specifications Settings	303
Output Data Settings (Processing Item Registration)	310
Testing Communications	318
I/O Signals	320
Output Items	330
Command Formats	332
Time Charts	336
Parallel Troubleshooting	347
3. Appendices	349
Command Control	350
Parameter Notation Examples for Command Control	350
Details of Commands Used in EtherCAT Communication	354
Command List	355
Command Details for PLC Link, EtherNet/IP, and EtherCAT	361
Non-procedure Command Details	426
Manual Revision History	520

Overview

This section provides a basic overview of the communications specifications and Sensor Controller control methods. This information is required before performing communications between the FH/FZ5 and an external device.

Introduction.....	12
Confirming the System Configuration.....	13
Communicating with an External Device	14
Control Methods Using an External Device	22
Setting Procedures for Communications.....	35
Differences in Specifications Based on the Communications Protocol.....	37

Introduction

This section provides a basic overview of the communications specifications and Sensor Controller control methods. This information is required before performing communications between the FH/FZ5 and an external device.

Confirming the System Configuration (Refer to ► [Confirming the System Configuration \(p.13\)](#))

This section describes the external device configuration that is required to perform measurement processing with the FH/FZ5.



Communicating with an External Device

This section describes the basic operations of the Sensor Controller, how the Sensor Controller works, and the specifications for communications between the Sensor Controller and an external device. The following information is provided.

Basic Flow of Communications and Signals (Refer to ► [Basic Control Operations of the Sensor Controller \(p.14\)](#))

- Process from Starting Measurements at the Sensor Controller to Data Output (Reference: [Communication between the Sensor Controller and an External Device \(p.16\)](#))
- Sensor Controller Control Methods (Control Signals, Commands, etc.) (Refer to ► [Control Methods for the Sensor Controller \(p.17\)](#))
- Types of Communications Protocols for Communicating with the Sensor Controller (Refer to ► [Communication Protocols for Communication with the Sensor Controller \(p.19\)](#))
- Moving Data between the Sensor Controller and an External Device (Refer to ► [Saving Sensor Controller Data to an External Device \(p.20\)](#))



Control Methods Using an External Device

This section describes the methods that you can use to control the Sensor Controller from an external device.

Control with Control Signals and Status Signals (Refer to ► [Control with Control Signals and Status Signals \(p.22\)](#))

Command/Response Method (Refer to ► [Command/Response Method \(p.25\)](#))

Data Output after Measurements (Refer to ► [Data Output after Measurements \(p.26\)](#))



Setting Procedures for Communications (Refer to ► [Setting Procedures for Communications \(p.35\)](#))

This section describes the procedures that are required to set up communications before starting communications between the Sensor Controller and an external device.



Differences in Specifications Based on the Communications Protocol (Refer to ► [Communications Protocols and Communications Modules \(p.36\)](#))

This section explains the types and differences of communication protocols that are used for communication with the Sensor Controller.

Confirming the System Configuration

The FH/FZ5 are Vision Systems that perform measurement processing through a Sensor Controller on measurement objects that are imaged by a Camera.

In a system configuration that is connected to a PLC, computer, or other external device, measurement commands can be received from and measurement results can be output to the external device.

System Configuration

An overview of the FH/FZ5 series system configuration is given below.

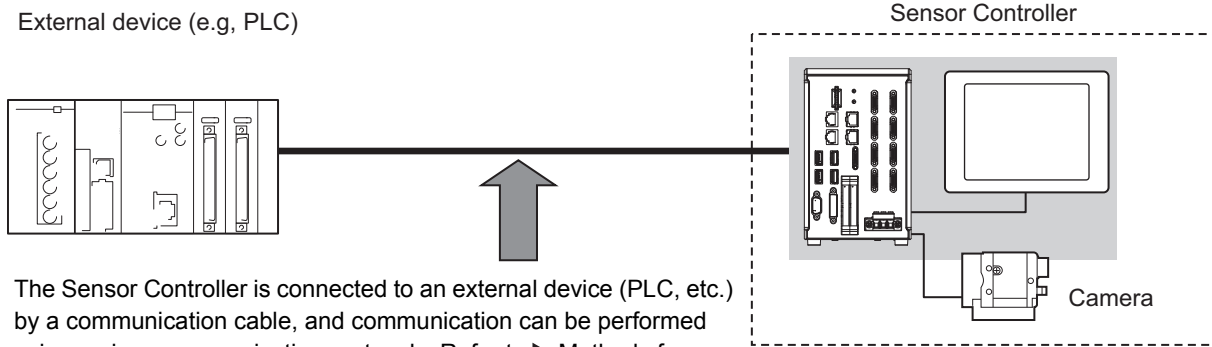

The Sensor Controller is connected to an external device (PLC, etc.) by a communication cable, and communication can be performed using various communication protocols. Refer to ► Methods for Connecting and Communicating with External Devices (p.43) for information on the different communications protocols.

An LCD monitor (BOX type only) for operation and monitoring and a camera are connected to the Sensor Controller unit.

For details, refer to the ► *Vision System FH/FZ5 Series User's Manual* (Cat. No. Z365) and the *Instruction Manual* that is provided with each individual device.

Communications protocol	Communications cable
Parallel	Parallel I/O cable
PLC Link	Ethernet cable
	RS-232C cable
EtherNet/IP	Ethernet cable
EtherCAT (FH-1000 series/ FH-3000 series only)	Ethernet cable
Non-procedure	Ethernet cable
	RS-232C cable

Communicating with an External Device

This section gives the communications specifications, describes the control methods that you can use for communications, and describes the settings that are required before starting communications with an external device.

Basic Control Operations of the Sensor Controller

The following figure shows basic communications between an external device and the Sensor Controller and the flow of signals and data.

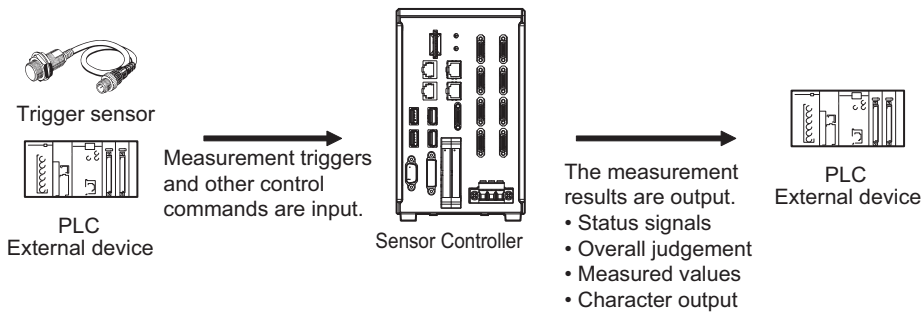

The following methods can be used to exchange data between an external device and the Sensor Controller.

Commands That Can Be Input to the Sensor Controller from an External Device

Type		Description
Control commands	Control signals (input signals)	A measurement is executed when a measurement trigger (i.e., an ON STEP signal) is input. For information on control signals, refer to ► Control with Control Signals and Status Signals (p.22).
	Communications command input	You can send commands to perform measurements, change scene groups, or perform other tasks. The communications commands depend on the communications protocol that you use. Refer to the section for each communications protocol for details.

Data Output to an External Device from the Sensor Controller

Type	Description
Status signals	When the Sensor Controller confirms a control signal or communications command input and begins measurement processing, the status of the Sensor is reported to the external device through status signals (e.g., a BUSY signal). For information on status signals, refer to ► Control with Control Signals and Status Signals (p.22).
Overall judgement	NG is output whenever there is one or more NGs in the judgement results for multiple processing items.*1 The overall judgement can be output through the OR signal or through the TJG output parameter. *1: This behavior can be changed in the settings. For information on the OR signal, refer to ► Control with Control Signals and Status Signals (p.22). For information on the TJG output parameter.
Measured values	The measured values from processing items can be output. The output items must be processing items for output and registered as output data (data 0 to data 7). Refer to ► Settings Required for Data Output (p.29) for details. You can also use commands to obtain results after a measurement is performed.

Type	Description
Character output (PLC Link or non-procedure communications only)	You can output character strings and numbers that are read by processing items such as Character Inspection, Barcode, or 2DCode. Refer to ► Items that Can Be Output as Output Data (p.28) for details. You can also use commands to obtain results after a measurement is performed.

Note

You can also use the FTP server to obtain logged image files and logged data files saved in the FH/FZ5 (or in external memory) from a web browser or FTP client.

Communication between the Sensor Controller and an External Device

Communication between the Sensor Controller and external device takes place as shown below. The following figure shows the flow when a communications command is used to start a measurement and then output data.

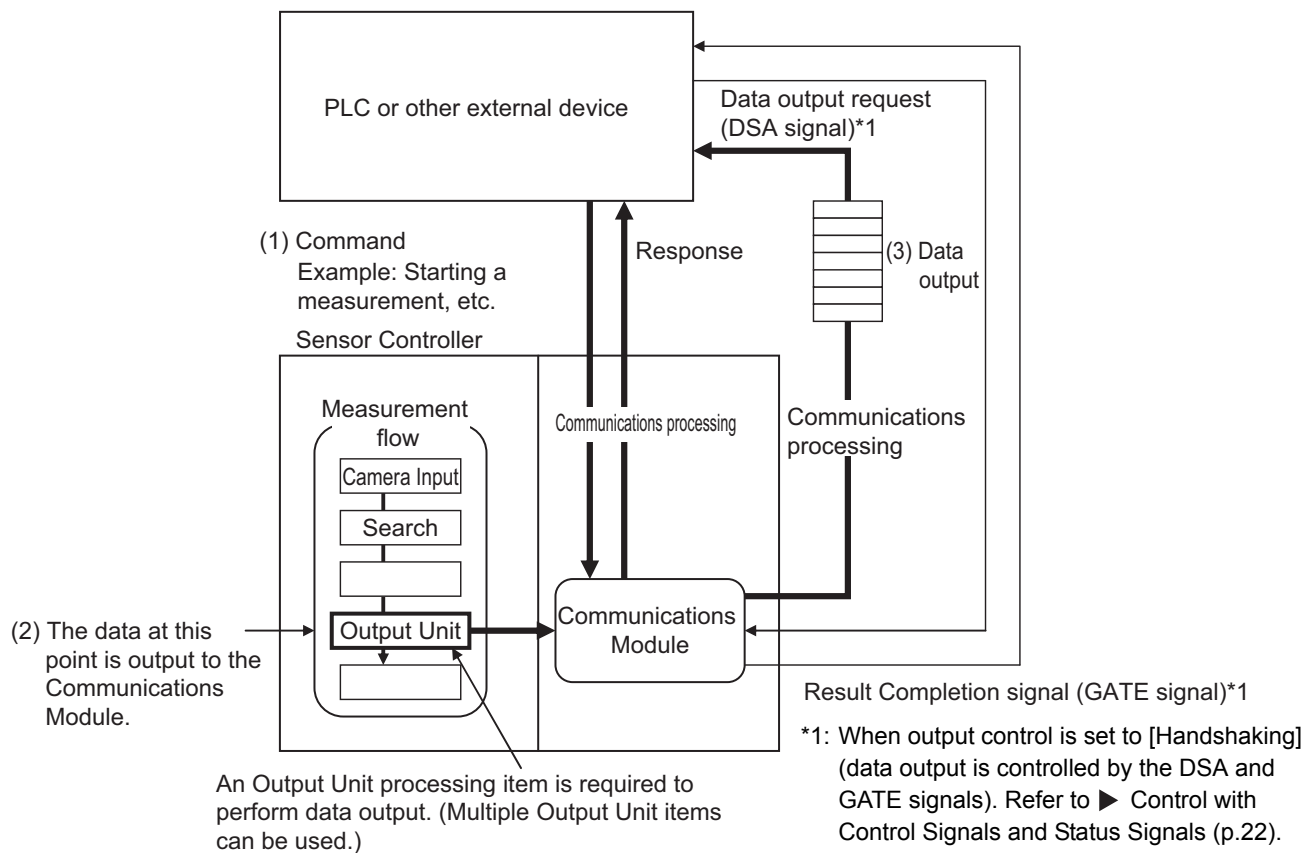

- (1) When the Sensor Controller receives a command from a PLC or other external device, it executes the command and returns a response.
- (2) The data obtained after the measurement is performed is output via the Communications Module by the Output Unit (an abbreviation for Results Output Unit) processing item in the measurement flow.
- (3) The measurement data is output when the Output Unit is executed, not when the measurement is actually finished.(*2)

*2: If handshaking is used for output control, the measurement data will remain in the Communications Module in a standby state until a data output request (DSA signal) is received from an external device. Refer to ► Data Output Control with Handshaking (p.32).

IMPORTANT

To output data, you must place an Output Unit processing item in the measurement flow.

You can place multiple Output Unit processing items in the measurement flow. Refer to ► Settings Required for Data Output (p.29).

Control Methods for the Sensor Controller

There are three methods that you can use to control the Sensor Controller from a PLC or other external device. They are described in this section.

For details on each control method, refer to their corresponding section.

Control Methods

Method	Overview	Trigger type or area	Signals or area used
Control signals and status signals	Operation is controlled by the ON/OFF status of the Measurement Trigger Signal (STEP) and Command Request Bit (EXE).	ON/OFF status of the control signals and status signals	Control signals and status signals
Control with commands and responses	Control is performed by sending control commands. The execution results of the command can be confirmed in the response from the Sensor Controller.	The control command code is stored in the I/O memory of the PLC and then the Request Bit is turned ON.	PLC I/O memory (Command Area and Response Area)
Data output after measurements	After a measurement is performed, the previously specified measurement data is output automatically.	Not required. (Output is performed automatically after measurement.)	PLC I/O memory (Data Output Area)

1 Control with Control Signals and Status Signals (Refer to ► Control with Control Signals and Status Signals (p.22))

Control and status confirmation for the Sensor Controller is performed with the ON/OFF status of the control and status signals.

This method is best suited for basic operations such as measurement triggers or to check the operating status of the Sensor Controller.

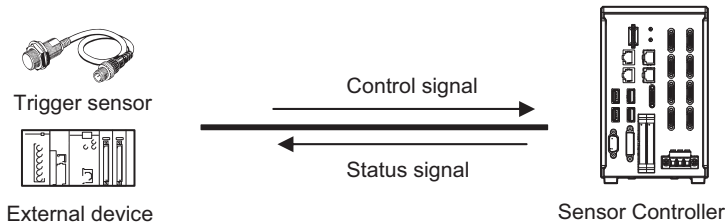

2 Command/Response Method (Refer to ► Command/Response Method (p.25))

Control is performed by storing the control command and the response to that command in the I/O memory of a PLC.

This method is best suited to send multiple commands to the Sensor Controller without using PLC communications instructions.

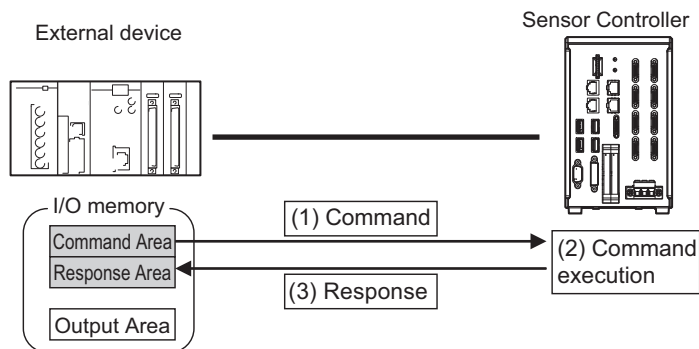

3 Data Output after Measurements (Refer to ► Data Output after Measurements (p.26))

After a measurement is executed, the measurement data specified for output is automatically output to the specified words in the I/O memory of the PLC.

This allows you to output measurement results from the Sensor Controller to the PLC automatically without having to send data requests from the PLC.

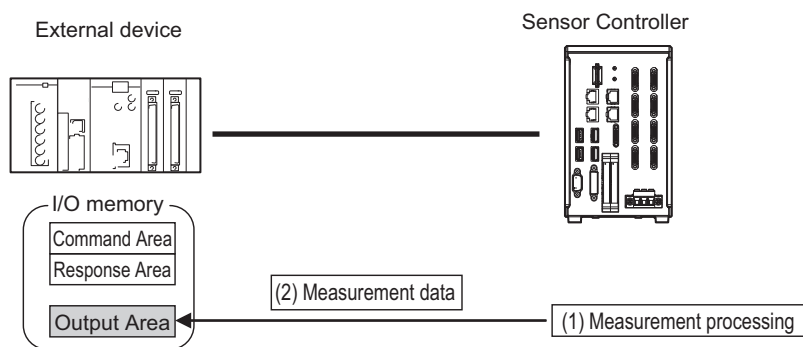

Communication Protocols for Communication with the Sensor Controller

The Sensor Controller can be controlled from a PLC, computer, or other external device using a variety of communication protocols.

The communication protocols that can be used to control the Sensor Controller from an external device are described below.

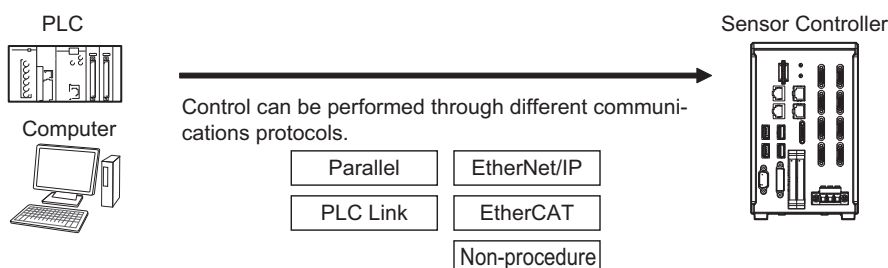

Applicable Communications Protocols

The communication protocols of each communication method that can be used with the Sensor Controller are as follows:

OK: Supported, ---: Not supported.

Communi- cations method	Communi- cations protocol	Overview	Communications cable type		
			Parallel I/O	Ethernet	RS-232C/ 422*2
Contact inputs	Parallel	Data is exchanged between an external device and the Sensor Controller through combinations of ON/OFF signals from multiple physical contacts.	OK	---	---
Data sharing	PLC Link	This is OMRON's communications protocol for Vision System. The control signals, Command Area/Response Area, and area to store measurement data are assigned in the I/O memory of the PLC, and data is exchanged cyclically to share data between the PLC and the Vision System.	---	OK	OK
	EtherNet/IP	This is an open communications protocol. Tag data links are used for communication with the Sensor Controller. On the PLC, structure variables are created that correspond to the control signals, command/response data, and measurement data. These variables are then used as tags to input and output data through tag data links to exchange data between the PLC and the Sensor Controller.*1	---	OK	---
	EtherCAT (FH-1000 series/FH- 3000 series only)	This is an open communications protocol. PDO (process data object) communications are used to communicate with the Sensor Controller. I/O ports that correspond to the control signals, command/response data, and measurement data are prepared in advance, and the variables assigned to those I/O ports are used to input and output data via PDO communications to exchange data between the PLC and the Sensor Controller.	---	OK	---

OK: Supported, ---: Not supported.

Communi- cations method	Communi- cations protocol	Overview	Communications cable type		
			Parallel I/O	Ethernet	RS-232C/ 422*2
Frame transmission	Non- procedure	Command frames are sent to the Sensor Controller and response frames are received from the Sensor Controller without the use of any specific protocol. Data can be exchanged between the PLC, computer, or other external device and the Sensor Controller by sending and receiving ASCII or binary format data.	---	OK	OK

*1: When connected to a CJ-series PLC, specify the areas in the I/O memory.

*2: FH-1000, FH-3000, and FH-L series are able to connect via only RS-232C.

Saving Sensor Controller Data to an External Device

In addition to sending and receiving data via a communication protocol, you can also save Sensor Controller data to an external device using the methods described below.

For details, refer to the ► *Vision System FH/FZ5 Series User's Manual* (Cat. No. Z365).

Connecting the FH/FZ5 as an External Drive

In addition to the Sensor Controller's built-in RAM disk, you can directly save various types of data such as scene data, scene group data, logged data, and logged images to the external media below.

- External Memory (Refer to ► *Using External Memory Devices* in the *Vision System FH/FZ5 Series User's Manual* (Cat. No. Z365).)
Data can be saved directly to a USB memory stick or SD Memory Card inserted into the slot on the Sensor Controller.
- Network Drive (Refer to ► *Shared folder on a computer connected to the network* in the *Vision System FH/FZ5 Series User's Manual* (Cat. No. Z365).)
You can save data directly to a shared folder on a computer connected via Ethernet.

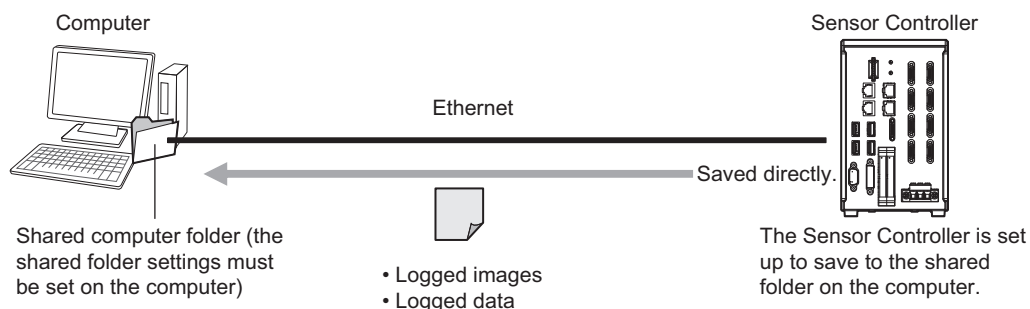

- Data Transfer (FTP Server) (Refer to ► *Saving Data to an External Device* in the *Vision System FH/FZ5 Series User's Manual* (Cat. No. Z365).)

You can move logged image files and other data saved in the Sensor Controller's RAM disk or a USB memory stick to a computer via Ethernet.

The computer must provide FTP client to access the FH/FZ5.

The computer cannot be accessed directly from the Sensor Controller.

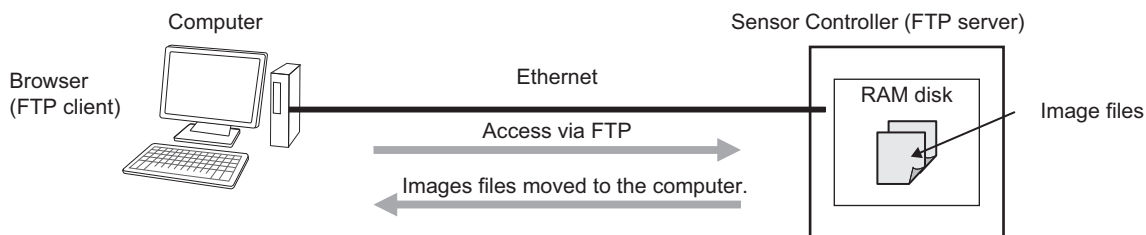

This enables you to move logged images off of the Sensor Controller's RAM disk before it becomes full.

- Remote Operation over a Network (Refer to ► *Remotely Operating the Controller (Remote Operation)* in the *Vision System FH/FZ5 Series User's Manual* (Cat. No. Z365).)

If more than one Sensor Controller is connected via Ethernet, a computer (the FH/FZ5 Tool) connected to the same Ethernet network can be used to operate and monitor all the Sensor Controllers at once.

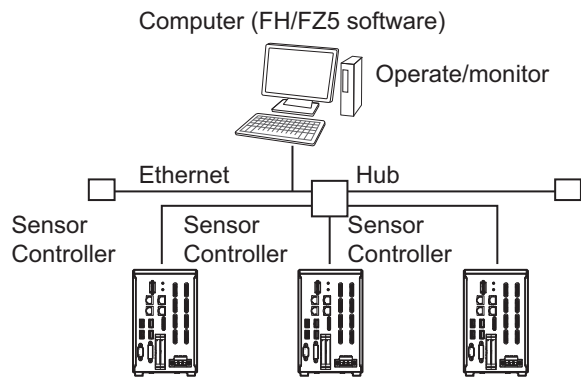

Control Methods Using an External Device

This section describes the methods that you can use to control the Sensor Controller from a PLC or other external device.

Control with Control Signals and Status Signals

Control and status confirmation for the Sensor Controller is performed with the ON/OFF status of the control and status signals.

Measurement triggers and other commands are input as control signals from the PLC.

The operating status of the Sensor, judgement results, and other status information can be confirmed through status signals sent from the Sensor Controller.

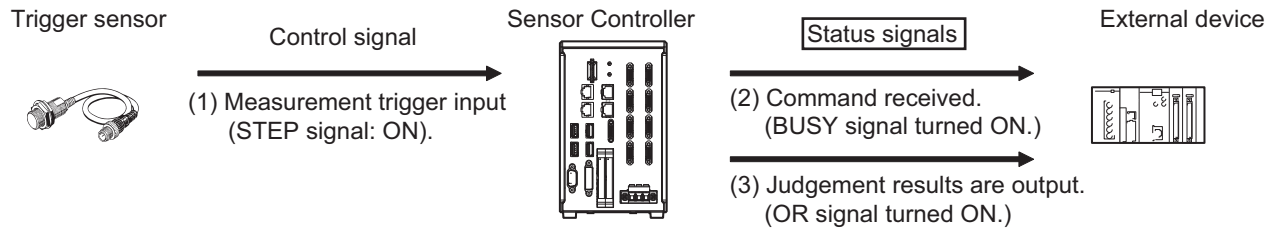

- (1) The external device turns ON the STEP signal to input a measurement trigger.
- (2) When the Sensor Controller confirms that the STEP signal is ON, it outputs the BUSY signal to the external device and begins a measurement.
- (3) When the Sensor Controller finishes the measurement, it outputs the judgement results on the OR signal.

Control Signals and Status Signals

The signals that the Sensor Controller can input and output as control signals and status signals are described in the following tables.

Input Signals (PLC to Sensor Controller)

Signal	Signal name	Function
EXE Command Request	Control Command Execution Signal	Turn ON this signal (from the PLC) to send a command to the FH/FZ5.
Trigger	Measure Bit	Turn ON this signal to execute measurements.
STEP	Measure Bit	Turn ON this signal to execute measurements.
DSA (Used only for handshaking output control.) Result Set Request	Data Output Request Signal	Use this signal (from the PLC) during handshaking to request from the FH/FZ5 the external output of the data output results from the execution of the measurement flow.
ERCLR Error Clear	Error Clear Bit	Turn ON this signal to clear the ERR signal from the Sensor Controller.
XEXE Flow Command Request	Flow Command Request Bit	Turn ON this signal to execute a command during execution of PLC Link, fieldbus, or parallel flow control.
DI (DI0 to DI7)	Command Input Signals	These signals are used to input commands from a parallel interface.

Signal	Signal name	Function
ENCTRIG	Encoder Trigger Input (Phase A, Phase B, or Phase Z)	This is the encoder input signal. This signal is only used when you use an encoder trigger.

Output Signals (Sensor Controller to PLC)

Signal	Signal name	Function
BUSY	Busy Signal	This signal tells when new commands and other external inputs cannot be acknowledged during processing of other external inputs. Just because this signal is ON does not necessarily mean that a command is being executed. To check whether a command is being executed, access the Command Completion (FLG) signal.
FLG Command Completion	Control Command Completion Signal	The FH/FZ5 uses this signal to tell the user (PLC) that command execution has been completed.
GATE Result Notification	Data Output Completion Signal	This signal tells the timing to load the output data to the User (PLC). Data output is enabled when this signal is ON.*1
READY Trigger Ready	Camera Image Input Enabled Signal	This signal indicates when the STEP (Measurement Trigger) signal or the Trigger signal can be input.*2 When using the multi-input function, the succeeding STEP or Trigger signals are accepted only after this signal turns ON.
OR Overall Judgment	Overall Judgement Output Signal	This signal gives the results of the overall judgement.*3
DO (DO0 to DO15)	Data Output Signals	These signals are used to output parallel data and parallel judgements through a parallel interface.
XFLG Flow Command Completion	Flow Command Completion Bit	This signal tells when execution of a command that was executed during execution of PLC Link or fieldbus flow control has been completed.
XBUSY Flow Command Busy	Measurement Command Busy Bit	This signal tells when a command that was input during execution of PLC Link or fieldbus flow control is being executed.
XWAIT Flow Command Wait	Measurement Command Wait Bit	This signal tells when input of a command can be acknowledged during execution of PLC Link or fieldbus flow control.
Trigger ACK	Trigger Signal Acknowledged Bit	The FH/FZ5 uses this signal to acknowledge reception of a Trigger signal.
Command Ready	Command Execution Ready Bit	This signal tells when control command can be executed.
ERR Error Status	Error Signal	The FH/FZ5 provides notification with this signal when it detects the following errors. Refer to ► <i>Error Messages and Troubleshooting</i> in the <i>Vision System FH/FZ5 Series User's Manual</i> (Cat. No. Z365). <ul style="list-style-type: none"> • Camera connection error • Battery error • Fan error • System error • Communications timeout • STEP input during measurement <p>The ERR signal does not turn OFF even after the error is eliminated. The signal turns OFF only when the error status is cleared by a control command.</p>

Signal	Signal name	Function
RUN	Measurement Mode Signal	This is a notification signal indicating the FH/FZ5 Sensor Controller is in Run mode (In a measurement capable state with [RUN signal output] checked in the Layout settings for the currently displayed line).
Run Mode		
ACK	Command Completion Flag	This signal tells when execution of the DI command has been completed.
SHTOUT	Exposure Completion Signal	This signal tells when Camera exposure has been completed.
STGOUT	Strobe Trigger Output	This is the trigger signal for the strobe.

- *1: This signal is linked to the Output Unit processing items in the measurement flow. It is not associated with the BUSY signal. It is not related to the parallel interface OR signal. Note that the operation is different when using PLC Link. See ► [Communicating with PLC Link \(p.162\)](#).
- *2: This signal is always OFF during display of a through image. If you use a Camera with Lighting Controller, the time required for the READY or Trigger Ready signal to turn OFF may increase in comparison with not using a Camera with a Lighting Controller. For details, refer to ► [Camera Image Input FH or Camera Image Input HDR](#) in the *Vision System FH/FZ5 Series Processing Items Reference Manual* (Cat. No. Z341).
- *3: The OR signal is output only when the [Output] option is selected in the Adjustment Window.

Command/Response Method

Parallel

Commands are input to the Sensor Controller by turning the DI signals (DI0 through DI7) ON and OFF. There is no direct response to these commands. Confirm whether a command was received by checking the ACK signal. With an FZ5-series Controller, you can check the BUSY status signal instead of the ACK signal. The command code is input with signals DI0 through DI6, and the command is executed by turning ON DI7.

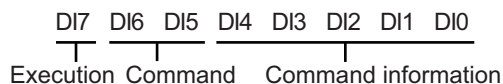

PLC Link, EtherNet/IP, or EtherCAT

Command/response control signals can be exchanged by storing control commands from the PLC to the Sensor Controller and responses from the Sensor Controller to the PLC in the I/O memory of the PLC. This enables you to send single measurement and scene switch requests to the Sensor Controller without any sequence control with communications commands from the PLC.

Memory Areas Used by the Command/Response Control Method

Command Area	You write the control commands to execute for the Sensor Controller to this area.
Response Area	You read the results of executing the control commands that were written to the Command Area from this area.

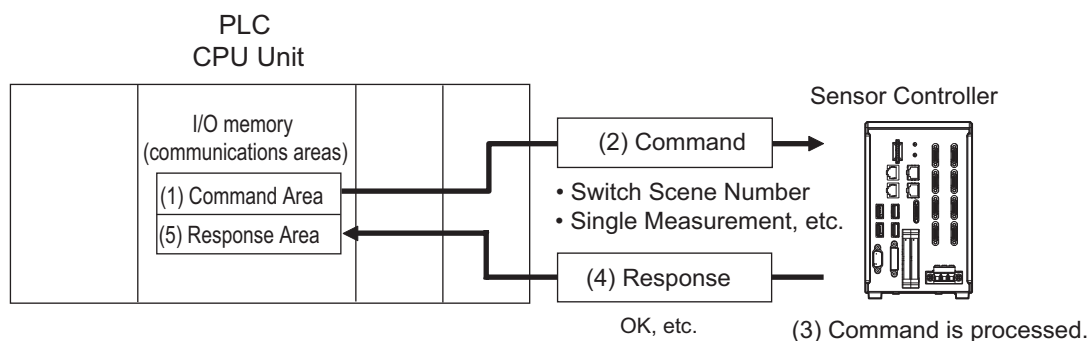

Flow of Communications between the PLC and the Sensor Controller

- (1) The PLC (the user) writes a control command to a specified PLC I/O memory area (the Command Area).
- (2) The PLC (the user) then turns ON the EXE bit to send the control command to the Sensor Controller.
- (3) The Sensor Controller executes the received control command.
- (4) The Sensor Controller returns a response to the PLC after the control command is executed.
- (5) The PLC (the user) stores the response in a specified PLC I/O memory area (the Response Area).

The available control commands depend on the communications protocol that is used.

Refer to the ► [Command List \(p.355\)](#).

Note

Command-driven character string output is not supported when using EtherNet/IP tag data link communication or EtherCAT.

To output character strings, send the commands using EtherNet/IP message communication.

Refer to the ► [Communicating with the Sensor Controller with EtherNet/IP Message Communications \(p.264\)](#)

Non-procedure Communications

Communications commands are sent to the Sensor Controller through sequence control in the PLC. An external device and the Sensor Controller communicate through non-procedure (normal) communications.

Data Output after Measurements

After a Single Measurement or Start Continuous Measurements command is executed, the Sensor Controller automatically outputs the data that corresponds to the measurements that have been specified as output items to the PLC. This allows you to easily pass measurement results data from the processing items to the PLC. You can also choose to output only when the PLC meets the conditions that are required to receive the data (i.e., when handshaking is turned ON).

The output destination for data depends on the protocol that is used to communicate between the external device and the Sensor Controller, as described below.

PLC Link, EtherNet/IP, or EtherCAT

The output data is automatically output to the following area that is specified PLC I/O memory.

Area of Memory Used for Data Output after Measurement

Data Output Area	The output data for the measurement is written to this area by the Sensor Controller after execution of the measurement.
-------------------------	--

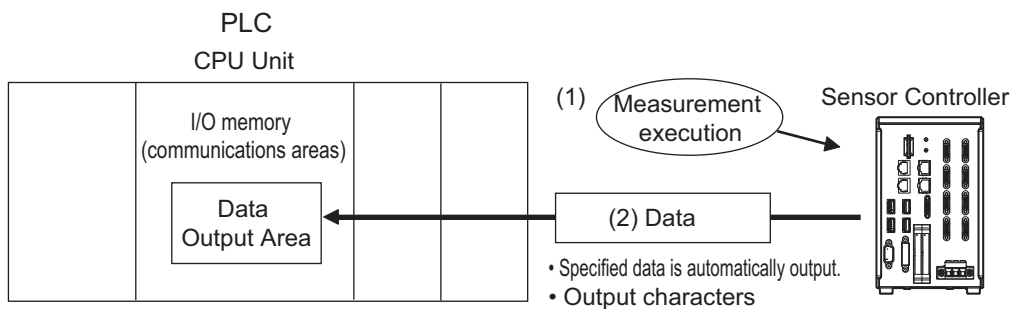

Flow of Communications between the PLC and the Sensor Controller

The data to output after measurement and the PLC I/O memory area (Data Output Area) to store that data are specified in advance. (Reference: Settings Required for Data Output (p.29).)

- (1) Measurement is executed.
- (2) After a measurement is executed, the specified measurement data is stored in the Data Output Area in the PLC.

Parallel

The output data is output to the PLC signal wires via the DO signals (DO0 to DO15).

Non-procedure Communications

The output data is output to the PLC reception buffer through non-procedure (normal) communications.

Outputting the Output Data

The measurement data is output to the external device via the Communications Module by the Data Output processing unit located in the measurement flow. Therefore, to output measurement data, you must place an Output Unit processing unit in the measurement flow. The measurement data is output when the Output Unit is executed, not when the measurement is actually finished.

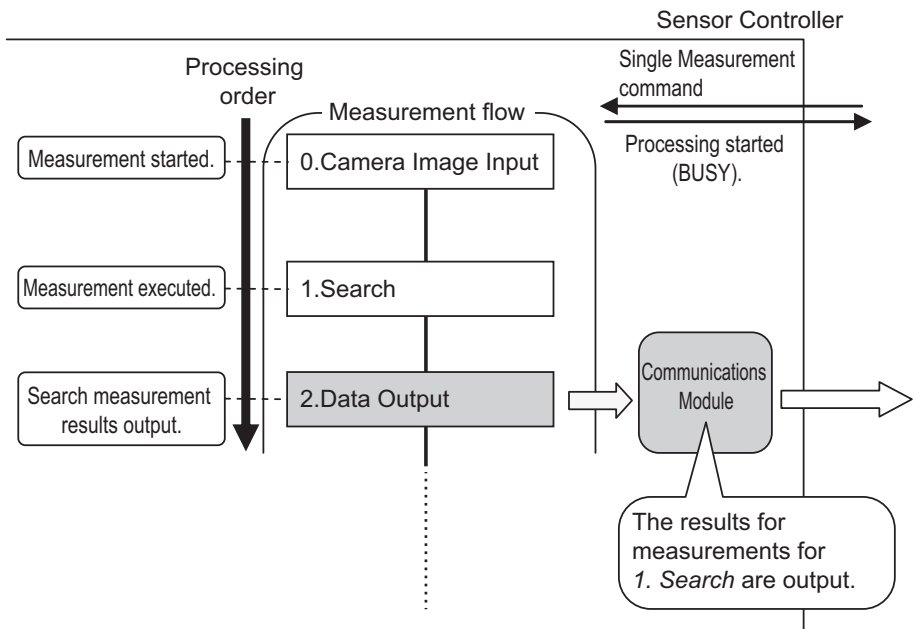

You can output character strings that were read by processing items that read characters, such as Character Inspection, Barcode, or 2DCode. (You must use PLC Link communications to do this.) Character strings are output simultaneously when the processing item is executed.

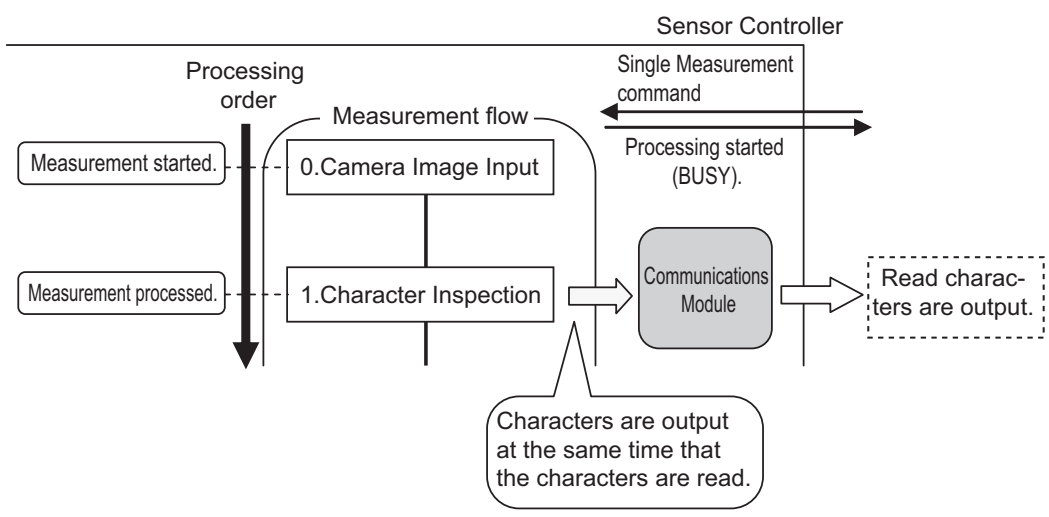

Note

Command-driven character string output is not supported when using EtherNet/IP tag data link communication or EtherCAT. To output character strings, send the commands using EtherNet/IP message communication. Refer to the ► Communicating with the Sensor Controller with EtherNet/IP Message Communications (p.264)

Measurement Data

You can output up to eight items (32 bytes) with one Output Unit processing unit.

Note

- If you need to output nine or more data items, set more than one Output Unit processing unit in the measurement flow.
Refer to ► [Outputting Multiple Measurement Data Items](#) (p.30).
 - The number of data items that can be output by one Output Unit processing unit can be increased by changing a setting when using PLC Link or EtherCAT communications, as described below.
 - PLC Link: 256 max. (1,024 bytes max.)
 - EtherCAT: 64 max. (256 bytes max.)
-

The following items can be output:

- Judgement result
- Measured parameters (correlation values, reference coordinates, etc.)
- Results calculated based on the values of the measured parameters
- Judgement results from expression results (Parallel Judgement Output)

Character Output (PLC Link Communications or Non-procedure Communications Only)

You can output the characters that were read by processing items such as Character Inspection.

- Character output is supported only for PLC Link communications or non-procedure communications.
- Maximum number of output characters are as follows.
 - Character Inspection: 32 characters
 - Barcode: 1024 characters
 - 2DCode: 652 characters
 - OCR: 128 characters (32 characters × 4 lines)
- The Read string is output as NULL(/0).

The processing items that support character output are listed below.

Refer to the descriptions for each processing item for details on the character output format.

- Character Inspection (Refer to ► [Character Inspection](#) in the *Vision System FH/FZ5 Series Processing Items Reference Manual* (Cat. No. Z341).)
- Barcode (Refer to ► [Barcode](#) in the *Vision System FH/FZ5 Series Processing Items Reference Manual* (Cat. No. Z341).)
- 2DCode (Refer to ► [2DCode](#) in the *Vision System FH/FZ5 Series Processing Items Reference Manual* (Cat. No. Z341).)
- OCR (Refer to ► [OCR](#) in the *Vision System FH/FZ5 Series Processing Items Reference Manual* (Cat. No. Z341).)

Note

Command-driven character string output is not supported when using EtherNet/IP tag data link communication or EtherCAT.

To output character strings, send the commands using EtherNet/IP message communication.

Refer to the ► [Communicating with the Sensor Controller with EtherNet/IP Message Communications](#) (p.264)

Settings Required for Data Output

Use the following procedure to set up Output Unit processing units for data output.

Measurement Data

1 Place the output data in the processing flow.

Place the processing unit for data output in the measurement flow.

Processing Units That Serve as Output Units

The processing items under [Output result] in the processing item tree in the Flow Editor serve as Output Units.

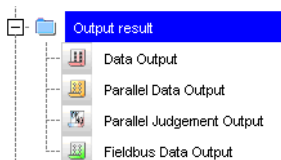

Output Unit Selection

Select the Output Units according to the communications protocol based on the combinations that are shown in the following table.

For information on communications protocols, refer to ► Communication Protocols for Communication with the Sensor Controller (p.19).

OK: Data can be output, ---: Data cannot be output.

Output unit	Communications protocol				
	Parallel	PLC Link	EtherNet/IP	EtherCAT	Non-procedure
Parallel Data Output	OK	---	---	---	---
Parallel Judgement Output	OK	---	---	---	---
Data Output	---	OK	---	---	OK
Fieldbus Data Output	---	---	OK	OK	---

2 Set the items to output.

Set the items to output as output data in the Output Units that you have placed in the measurement flow.

Refer to the descriptions for the communications protocol for the specific procedures to set the output items in the Output Units.

Character Output (PLC Link Non-procedure Communications Only)

Set the character output settings for processing items that read output characters, such as Character Inspection.

The character output operation is executed by the above processing items. In this case, it is not necessary to set an Output Unit in the measurement flow.

Refer to the descriptions for individual processing items for details on the settings required for character output.

- Character Inspection (Refer to ► *Character Inspection* in the *Vision System FH/FZ5 Series Processing Items Reference Manual* (Cat. No. Z341).)
- Barcode (Refer to ► *Barcode* in the *Vision System FH/FZ5 Series Processing Items Reference Manual* (Cat. No. Z341).)
- 2DCode (Refer to ► *2DCode* in the *Vision System FH/FZ5 Series Processing Items Reference Manual* (Cat. No. Z341).)

- OCR (Refer to ► OCR in the Vision System FH/FZ5 Series Processing Items Reference Manual (Cat. No. Z341).)

Note

Command-driven character string output is not supported when using EtherNet/IP tag data link communication or EtherCAT.

To output character strings, send the commands using EtherNet/IP message communication.

Refer to the ► Communicating with the Sensor Controller with EtherNet/IP Message Communications (p.264)

Outputting Multiple Measurement Data Items

Using Multiple Output Units for Data Output

You can register more than one Output Unit in the measurement flow.

If you want to output different types of data during measurement flow processing, or if you want to output more than nine different data items, you must register multiple Output Units in the measurement flow.

Data output is executed for each Output Unit set in the measurement flow, but the output destination for that data is the same PLC I/O memory area (the Data Output Area).

In this case, the output data that is output first will be overwritten by any output data written afterwards. Use one of the following methods if you want to save all the output data.

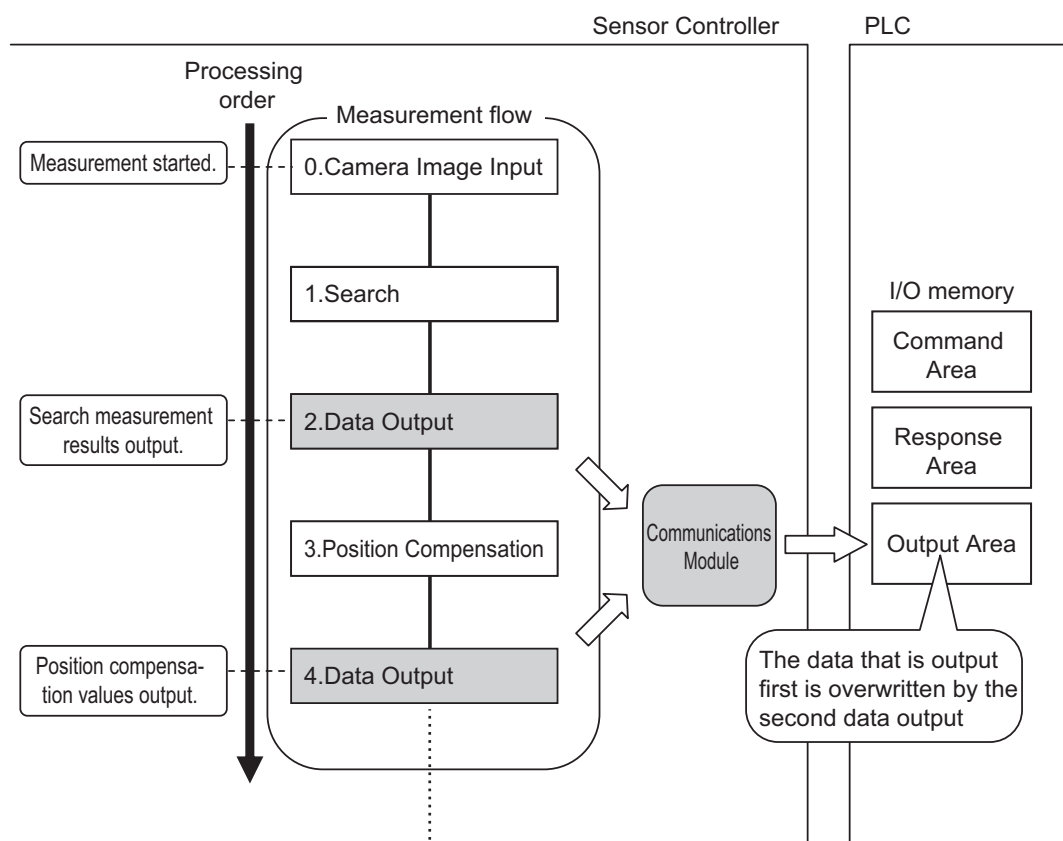

Offsets (PLC Link Communications Only)

When you use multiple Output Units to output data, you can offset the write destination of the output data for each Output Unit.

Set the [Offset] for the Data Output processing item. Refer to ► Output Data Settings (Processing Item Registration) (p.232).

Controlling Data Output with Handshaking

If handshaking is used to control data output, the timing of outputting the data is controlled by I/O signals. Each time that data is output, read the output data and move it to a different part of I/O memory in the PLC.

Refer to ► Data Output Control with Handshaking (p.32).

Note

For ASCII data output through non-procedure communications, you can append a record separator after each output data item. (The default is the delimiter.)

The following two types of output units can be used via parallel communications:

Output unit	Output data
Parallel Data Output	The measurement data is output. A maximum of eight items can be output.
Parallel Judgement Output	The judgement results are output. A maximum of 16 judgement result items can be output. The following two types of judgement results can be output: <ul style="list-style-type: none"> • Judgement results for specified processing items • Judgement results of set judgement conditions for the specified item values

Parallel Data Output Units and Parallel Judgment Output Units are output in the order they are processed in the measurement flow.

Outputting Multiple Items with Parallel Data Output

The items that are set for output data numbers 0 through 7 via parallel data output are output to the PLC reception buffer in ascending order, one data item at a time (16-bit units). Each time a data item is output, the GATE signal turns ON.*1

When this occurs, the first data item that was output to the PLC reception buffer (data 0) is overwritten by the next output data item (data 1).

Therefore, the data output to the PLC reception buffer must be saved to PLC memory each time the GATE signal turns ON for each data item.

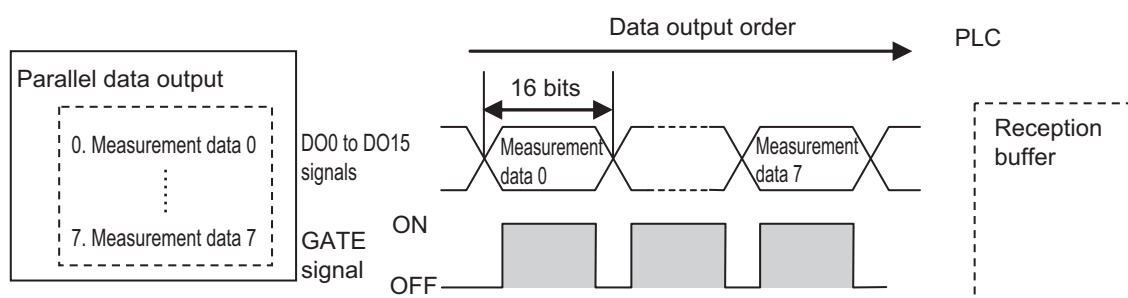

*1: The operation of the DSA signal depends on whether handshaking for output control is enabled. Reference: Data Output Control with Handshaking (p.32).

Data Output Control with Handshaking

The timing for data output can be controlled through the DSA and GATE signals.

This is useful when receiving output data from multiple Output Units, because it enables you to control the timing for transferring output data.

Requirements for Using Data Output Control with Handshaking

To use data output control, set the output control method to [Handshaking] in the communications protocol settings. For details, refer to ► *Communications Specifications Settings* for each communications protocol.

Parallel Communications: Refer to ► *Communications Specifications Settings* (p.303).

PLC Link Communications: Refer to ► *Communications Specifications Settings* (p.166).

EtherNet/IP and EtherCAT Communications: Refer to ► *Communications Specifications Settings* (p.63 or p.222).

Handshaking

If the external device does not turn ON the DSA signal, the measurement data will not be output to the external device from the Sensor Controller.

While the DSA signal is ON, the GATE signal turns ON when the measurement data is output from the Sensor Controller.

The external device receives the measurement data when the GATE signal turns ON.

Signals Used for Handshaking

Signal	Name	Description
DSA	Data Output Request Signal	This signal is sent from the external device (PLC) to the Sensor Controller to request data output.
GATE	Data Output Completion Signal	This signal is sent by the Sensor Controller to the external device (PLC) to tell the PLC when to receive the output data. This signal is sent only while the DSA signal is ON.*1

*1: If handshaking is not enabled for output control, the GATE signal will also be turned ON when data is output from the Sensor Controller. However, if handshaking is disabled for output control during PLC Link communications, the GATE signal is not even output.

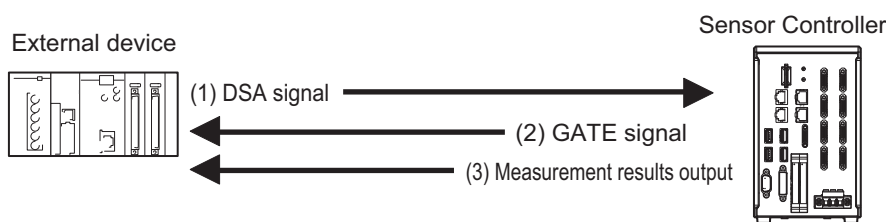

(1) The PLC turns ON the DSA signal and waits for the output data.

(2) The Sensor Controller turns ON the GATE signal when the DSA signal is ON and it is ready to output the measurement results(*1).

(3) The Sensor Controller turns ON the GATE signal and outputs the output data.

*1: This is when an Output Unit in the measurement flow is executed.

DSA Signal ON Timing

Turn ON the DSA signal when you want to receive data.

The Sensor Controller will output data when an Output Unit has been executed, there is data waiting to be output, and it detects that the DSA signal is ON.

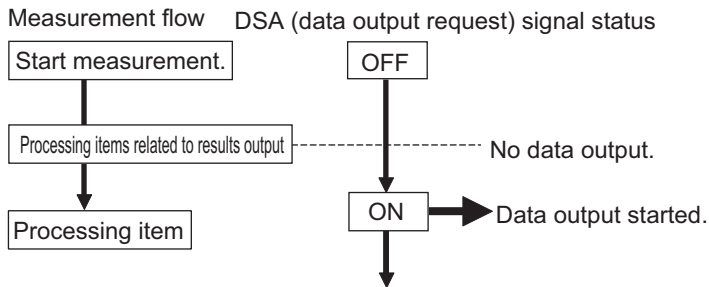

To output measurement results immediately, execute the measurement trigger and turn ON the DSA signal. The Sensor Controller does not monitor when the DSA signal changes from OFF to ON. It only checks for the ON state.

Therefore, the measurement results will be output from the Sensor Controller to the external device immediately after an Output Unit is executed and the output data must be received by the PLC at this time.

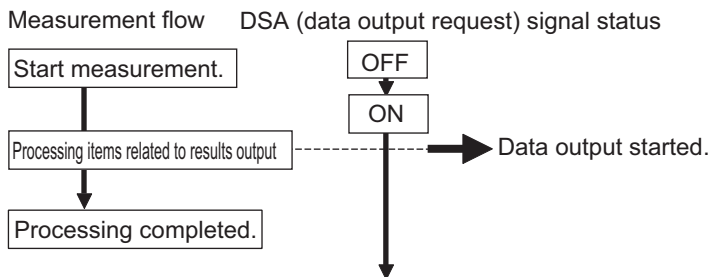

Receiving Multiple Continuous Output Data Items

When receiving multiple output data items from multiple Output Units, use the DSA and GATE signals to receive the items one at a time.

Example: PLC Link Communications with Handshaking

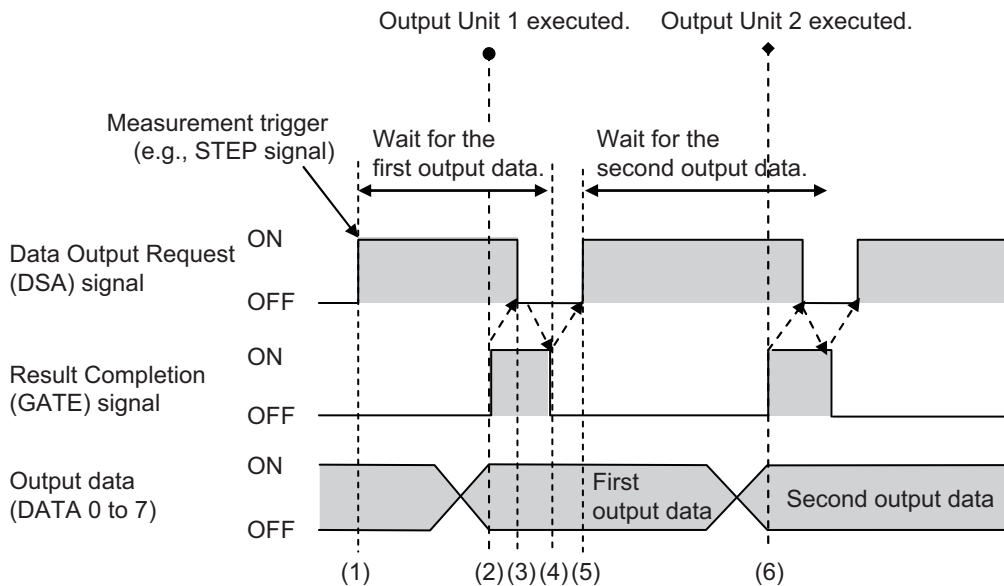

- 1** When the first data is received, the user (PLC) turns ON the measurement trigger and the DSA signal.
- 2** The Sensor Controller turns ON the GATE signal when the DSA signal is turned ON and outputs the first data.
- 3** The user (PLC) turns OFF the DSA signal again when the GATE signal turns ON. Then, the user (PLC) confirms the output data received in the PLC Data Output Area and moves the received data to another area in PLC I/O memory.
- 4** The Sensor Controller confirms that the DSA signal is OFF and automatically turns OFF the GATE signal.
- 5** The user (PLC) then turns ON the DSA signal again after the output data is received and the GATE signal is turned OFF, and waits for the second data.
- 6** When the second data is output, the second data output is received when the GATE signal is turned ON and steps 3 and 5 above are repeated.

Steps 3 through 5 above are repeated for all subsequent data output items.

Setting Procedures for Communications

This section gives an overview of the setting procedure up to the point that the Sensor Controller starts communication with the PLC or other external device, and explains the communication modules used for communication.

Note

For connection with a Touch Panel Monitor, refer to ► *Settings for Touch Panel Monitor* in the *Vision System FH/FZ5 Series User's Manual* (Cat. No. Z365).

Communications Setup Procedures

To communicate with an external device, the settings below are configured.

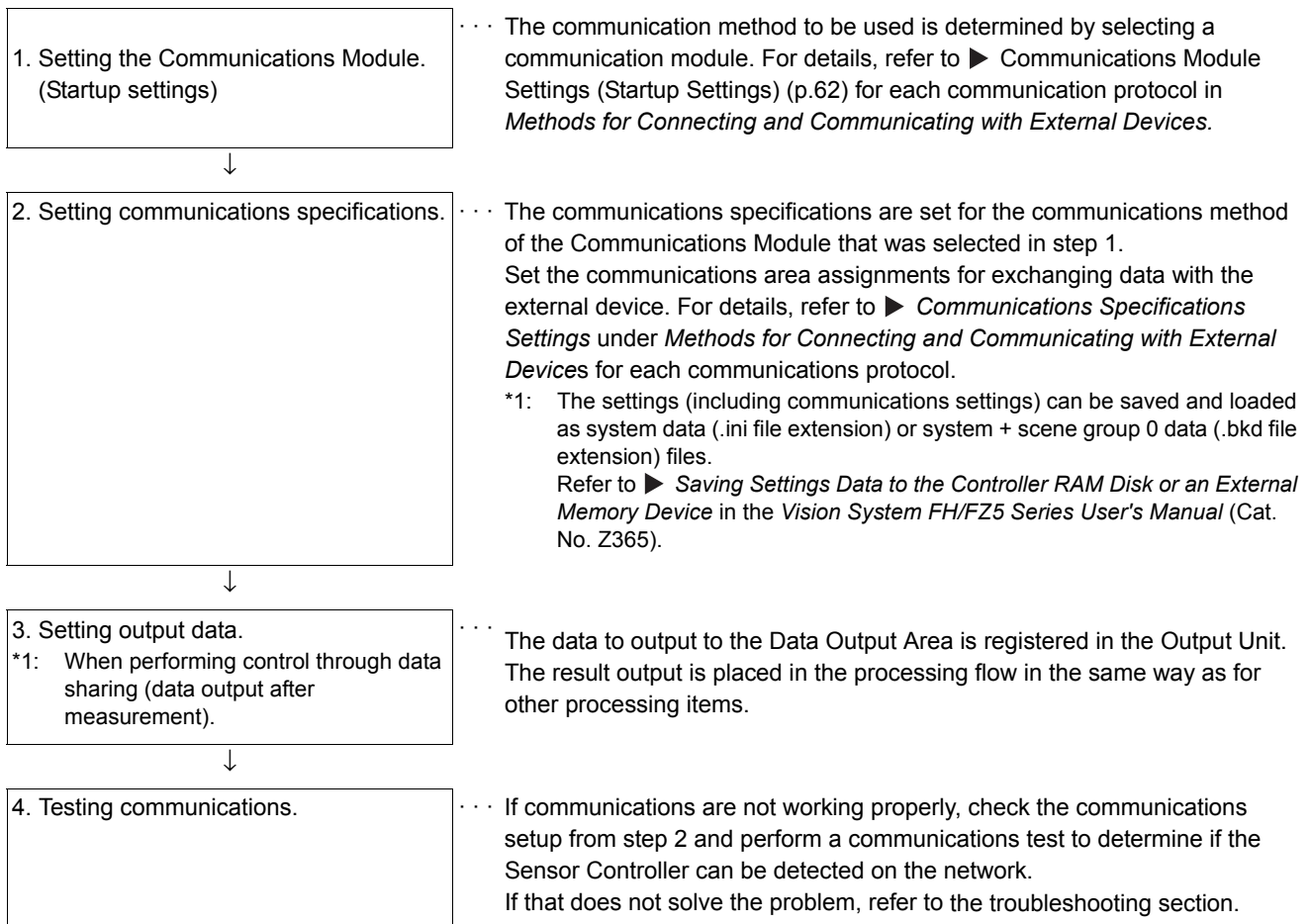

Communications Protocols and Communications Modules

A Communications Module is used to communicate between the Sensor Controller and an external device. The appropriate Communications Module must be set for the communications protocol that is used to communicate between the Sensor Controller and the external device.

Communications Module Settings

The Communications Module to use for communications is selected in the startup settings.

- 1** On the Main Window, select [Tool] – [System Settings] to open the system settings.
- 2** Select [System setting] – [Startup] – [Startup setting] on the Multiview Explorer on the left and then click the [Communication] tab.

For detailed setting procedures, refer to ► *Communications Module Settings* for each communications protocol.

IMPORTANT

After you select the Communications Module to use, save the settings to the Sensor Controller and restart the Sensor Controller.

The selected Communications Module will be enabled after the Sensor Controller restarts. You can then set up the communications.

Selecting a Communications Module

Select a Communications Module based on the communications protocol to use to communicate between the Sensor Controller and external device and the connected communications interface, as shown in the following table.

Communications protocol	Communications interface	Communications Module
Parallel	Parallel	Standard Parallel I/O
PLC Link	Ethernet	Serial (Ethernet) PLC Link (SYSMAC CS/CJ/CP/One) (UDP) PLC Link (SYSMAC CS/CJ/CP/One) (TCP) PLC Link (MELSEC QnU/Q/QnAS) (UDP) PLC Link (MELSEC QnU/Q/QnAS) (TCP) PLC Link (JEPMC MP)
	RS-232C/422	Serial (RS-232C/422) PLC Link (SYSMAC CS/CJ/CP/One) PLC Link (MELSEC QnU/Q/QnAS)
EtherNet/IP	EtherNet/IP	Fieldbus EtherNet/IP EtherCAT
EtherCAT	EtherCAT	
Non-procedure	Ethernet	Serial (Ethernet) Normal (UDP) Normal (TCP) Normal (TCP Client) Normal (UDP) (Fxxx series method)
	RS-232C/422	Serial (RS-232C/422) Normal Normal (Fxxx series method)

Differences in Specifications Based on the Communications Protocol

This section explains the types and differences of communication protocols that are used for communication with the Sensor Controller.

List of Supported Signals by Communications Protocol

Some of the control signals and status signals that can be used depend on the communications protocol as shown below.

The table below can be used to check which signals exist in each communication protocol by means of a vertical arrangement.

Note that this table does not show whether signals of one communication protocol can be used simultaneously with signals of other communication protocols.

For restrictions on communication protocols that can be used simultaneously, refer to ► Restrictions when Using Different Communication Protocols Simultaneously (p.39).

IMPORTANT

The control signals and status signals cannot be used for control in non-procedure communications.

Input Signals (PLC to Sensor Controller)

OK: Can be used, ---: Cannot be used.

Signal	Signal name	Signals for each communications protocol			
		Parallel	PLC Link	EtherNet/IP	EtherCAT
EXE	Control Command Execution Signal	---	OK	OK	---
Command Request		---	---	---	OK
Trigger	Measure Bit	---	---	---	OK
STEP	Measure Bit	OK	---	OK	---
DSA (Used only for handshaking output control.)	Data Output Request Signal	OK	OK	OK	---
Result Set Request		---	---	---	OK
ERCLR	Error Clear Bit	---	---	OK	---
Error Clear		---	---	---	OK
XEXE	Flow Command Request Bit	---	OK	OK	---
Flow Command Request		---	---	---	OK
DI (DI0 to DI7)	Command Input Signals	OK	---	---	---
ENCTRIG	Encoder Trigger Input (Phase A, Phase B, or Phase Z)	OK	---	---	---

Output Signals (Sensor Controller to PLC)

OK: Can be used, ---: Cannot be used.

Signal	Signal name	Signals for each communications protocol			
		Parallel	PLC Link	EtherNet/IP	EtherCAT
BUSY	Busy Signal	OK* ¹	OK* ¹	OK* ¹	OK* ¹
FLG	Control Command Completion Signal	---	OK	OK	---
Command Completion		---	---	---	OK
GATE	Data Output Completion Signal	OK	OK* ²	OK	---
Result Notification		---	---	---	OK
READY	Camera Image Input Enabled Signal	OK	---	---	---
Trigger Ready		---	---	---	OK
OR	Overall Judgement Output Signal	OK	---* ³	OK	---
Overall Judgment		---	---	---	OK
One-shot OR * ⁴	One-shot Overall Judgement Result Signal	OK	---	---	---
DO (DO0 to DO15)	Data Output Signals	OK	---	---	---
XFLG	Flow Command Completion Bit	---	OK	OK	---
Flow Command Completion		---	---	---	OK
XBUSY	Measurement Command Busy Bit	---	OK	OK	---
Flow Command Busy		---	---	---	OK
XWAIT	Measurement Command Wait Bit	---	OK	OK	---
Flow Command Wait		---	---	---	OK
Trigger ACK	Trigger Signal Acknowledged Bit	---	---	---	OK
Command Ready	Command Execution Ready Bit	---	---	---	OK
ERR	Error Signal	OK	---	OK	---
Error Status		---	---	---	OK
RUN	Measurement Mode Signal	OK	---	OK	---
Run Mode		---	---	---	OK
ACK	Command Completion Flag	OK	---	---	---
SHTOUT	Exposure Completion Signal	OK	---	---	OK
STGOUT	Strobe Trigger Output	OK	---	---	---

- *1: The execution of commands or other processing received through any other protocol cannot be detected.
The parallel BUSY signal can be used in all protocols.
If you use more than one protocol and need to detect command execution, use the parallel communications BUSY signal.
- *2: Data is not output when there is no handshaking for the PLC Link protocol.
- *3: The OR signal cannot be used with PLC Link communications.
- *4: The One-shot OR signal can be used only with parallel communications.

Restrictions when Using Different Communication Protocols Simultaneously

Different communication protocols can be used together on the FH/FZ5. Restrictions when using different protocols together are as follows:

- The Parallel Communications Module can be used with any other Communications Modules.
- For all Communication Modules other than the Parallel Communications Module, the following restrictions on combinations apply.
 - Ethernet and RS-232C/422 cannot be used at the same time as PLC Link for Vision Systems.
 - EtherNet/IP or EtherCAT cannot be used at the same time as PLC Link for Vision Systems.
 - All combinations of Communications Modules other than those listed above are compatible.

IMPORTANT

If control signals or commands are input simultaneously to the Sensor Controller from different Communications Modules, they may not be received correctly. Check the status signals for each Communications Module and input control signals and commands at different times for each.

Communication protocol restrictions by operation mode

The FH Series/FZ5-1100 Series Sensor controller has an Operation mode selection.

The following are the primary restrictions associated with each of the respective Operation modes.

For more information on these restrictions, refer to the following.

(Reference: ► "Setting the Operation Mode" in the "Vision System FH/FZ5 Series User's Manual (Z365)")

● Double Speed Multi-input

- To use the multi-input function, please use it in Parallel or EtherCAT which allow checking the status of the READY signal. In the case of EtherCAT, check the status of the Trigger Ready signal instead of the READY signal.
- While using the multi-input function, most of the load on the CPU is allocated to measurement processing, which may cause performance degradation (response delay, packet loss) and communication errors. Do not use EtherNet/IP communication while using the Multi-input function.
- If you continue to input the trigger at the speed which is not synchronized to the communication output speed, there is a risk of STEP not being output, or delays in measurement. Please make the trigger timing so it has no delay with the communication.

● Multi-line random-trigger mode

- In non-procedure (RS-232C/422) and PLCLink (RS232C/422) only Line 0 can be used.
- Depending on the communication protocol, settings may be required for each line.
- In the case of Parallel, there are differences in Parallel I/O function and Parallel terminal depending on the number of lines.

● Non-stop adjustment mode

- Communication commands that can be received during Nonstop data transfer are only measurement commands (Parallel / non-procedure / PLCLink) and continuous measurement commands (Parallel only).

Models That Are Compatible with the Communications Protocols

This section lists the external devices that can communicate with the FH/FZ5 for each communications protocol.

PLC Link and Non-procedure Communications

- Ethernet

OMRON

○: Can connect △: Only some models can connect ×: Cannot connect

Series	CPU Unit	Interface	
		Direct connection with CPU unit (built-in port)	Connection via Ethernet unit
SYSMAC_CJ2	CJ2H or CJ2M	△(Built-in port only.)	CJ1W-EIP21 (PLC Link only) or CJ1W-ETN21
SYSMAC_CJ1	CJ1H or CJ1G	×	CJ1W-EIP21 (PLC Link only) or CJ1W-ETN21
	CJ1M	△(Built-in port only.)	CJ1W-EIP21 (PLC Link only) or CJ1W-ETN21
SYSMAC_CS	CS1H, CS1D, or CS1G	×	CS1W-EIP21 (PLC Link only) or CS1W-ETN21
SYSMAC_CP1	CP1L	△(Built-in port only.)	---
	CP1H	×	CJ1W-EIP21 (PLC Link only) or CJ1W-ETN21
SYSMAC_One	NSJ	×	NSJW-ETN21

Mitsubishi Electric

○: Can connect △: Only some models can connect ×: Cannot connect

Series	Model name	CPU Unit	CPU name	Interface	
				Direct connection with CPU unit (built-in port)	Connection via Ethernet unit
MELSEC-QnU	Universal models	QnUDECPU	Q03UDECPU, Q04UDEHCPU, Q06UDEHCPU, Q10UDEHCPU, Q13UDEHCPU, Q20UDEHCPU, or Q26UDEHCPU	○	QJ71E71-100 QJ71E71-B2 QJ71E71-B5
		QnUDCPU	Q03UDCPU, Q04UDHCPU, Q06UDHCPU, Q10UDHCPU, Q13UDHCPU, Q20UDHCPU, or Q26UDHCPU	×	
		QnUCPU	Q00UJCPU, Q00UCPU, Q01UCPU, or Q02UCPU,	×	
	Basic models	QnCPU	Q00JCPU, Q00CPU, or Q01CPU	×	
MELSEC-Q Series	High-performance models	QCPU	Q02CPU, Q02HCPU, Q06HCPU, Q12HCPU, or Q25HCPU	×	
MELSEC-QnAS Series	---	---	Q2ASCPU, Q2ASCPU-S1, Q2ASHCPU, or Q2ASHCPU-S1	×	

- RS-232C/422

OMRON

○: Can connect △: Only some models can connect ×: Cannot connect

Series	CPU Unit	Interface	
		Direct connection with CPU unit (built-in port)	Connection via serial communication unit
SYSMAC_CJ2	CJ2H	○	CJ1W-SCU21-V1, CJ1W-SCU31-V1, CJ1W-SCU41-V1, CJ1W-SCU22, CJ1W-SCU32, or CJ1W-SCU42
	CJ2M	△ (Built-in port only.)	
SYSMAC_CJ1	CJ1H, CJ1G, or CJ1M	○	CJ1W-SCU21-V1, CJ1W-SCU31-V1, CJ1W-SCU41-V1, CJ1W-SCU22, CJ1W-SCU32, or CJ1W-SCU42
SYSMAC_CS	CS1H, CS1D, or CS1G	○	CS1W-SCB□□-V1, CS1W-SCU21-V1, or CS1W-SCU31-V1
SYSMAC_CP1	CP1E, CP1L, or CP1H	×	CP1W-CIF01
SYSMAC_One	NSJ	○	---
SYSMAC_NJ	NJ501 or NJ301	---	CJ1W-SCU22, CJ1W-SCU32, or CJ1W-SCU42

Mitsubishi Electric

○: Can connect △: Only some models can connect ×: Cannot connect

Series	Model name	CPU name	CPU Unit	Interface	
				Direct connection with CPU unit (built-in port)	Connection via serial communication unit
MELSEC-QnU	Universal models	QnUDECPU	Q03UDEHCPU, Q04UDEHCPU, Q06UDEHCPU, Q10UDEHCPU, Q13UDEHCPU, Q20UDEHCPU, or Q26UDEHCPU	×	QJ71C24N or QJ71C24N-R2
		QnUDCPU	Q03UDHCPU, Q04UDHCPU, Q06UDHCPU, Q10UDHCPU, Q13UDHCPU, Q20UDHCPU, or Q26UDHCPU	○	
		QnUCPU	Q00UJCPU, Q00UCPU, Q01UCPU, or Q02UCPU	○	
	Basic models	QnCPU	Q00JCPU, Q00CPU, or Q01CPU	○	
MELSEC-Q Series	High-performance models	QCPU	Q02CPU, Q02HCPU, Q06HCPU, Q12HCPU, or Q25HCPU	×	
MELSEC-QnAS Series	---	---	Q2ASCPU, Q2ASCPU-S1, Q2ASHCPU, or Q2ASHCPU-S1	×	A1SJ71QC24N1 or A1SJ71QC24N1-R2

• **EtherNet/IP**

○: Can connect △: Only some models can connect ×: Cannot connect

Series	CPU Unit	Interface	
		Direct connection with CPU unit (built-in port)	Connection via EtherNet/IP unit
SYSMAC NJ	NJ501 or NJ301	○	CJ1W-EIP21 (Only version 2.1 supports Sysmac NJ connection. This applies to NJ versions 1.01 and later.)
SYSMAC_CJ2	CJ2M or CJ2H	△ (Built-in port only.)	CJ1W-EIP21
SYSMAC_CJ1	CJ1H or CJ1G	×	CJ1W-EIP21
	CJ1M	△ (Built-in port only.)	CJ1W-EIP21
SYSMAC_CS	CS1H, CS1D, or CS1G	×	CS1W-EIP21

• **EtherCAT**

○: Can connect △: Only some models can connect ×: Cannot connect

Series	CPU Unit	Interface	
		Direct connection with CPU unit (built-in port)	Connection via master unit
SYSMAC NJ	NJ501 NJ301	○	---

Methods for Connecting and Communicating with External Devices

This section describes the communications specifications, data I/O methods, communications settings, communications commands, and other details for each communications protocol used to communicate between the FH/FZ5 and external devices.

EtherCAT Connections (FH-1000 series/FH-3000 series only).....	44
Communicating with PLC Link.....	162
Communicating with EtherNet/IP.....	213
Non-procedure Communications.....	269
Parallel Communications.....	299

EtherCAT Connections (FH-1000 series/FH-3000 series only)

This section explains the communication settings required for communication by EtherCAT between the Sensor Controller and an external device, communication specifications, input/output formats, and the communication timing chart.

Introduction to EtherCAT

EtherCAT (Ethernet Control Automation Technology) is a high-performance industrial network system that enables faster and more efficient communications based on Ethernet.

Each node achieves a short communications cycle time by transmitting Ethernet frames at high speed.

Although EtherCAT is a unique communications protocol, standard Ethernet technology is used for the physical layer, which means you can use Ethernet cables for wider application.

And the effectiveness of EtherCAT can be fully utilized not only in large control systems that require high processing speeds and system integrity, but also in small and medium control systems.

How EtherCAT Works

In EtherCAT communication, Ethernet frames pass through all of the slave nodes.

When a frame passes through a slave node, the slave node reads and writes the data in the area that is allocated to it in the frame in a few nanoseconds.

The Ethernet frames that are transmitted by the EtherCAT master pass through all EtherCAT slaves without stopping. The last slave returns all of the frames, which again pass through all of the slaves before returning to the EtherCAT master.

This mechanism ensures high speed and realtime data transmission.

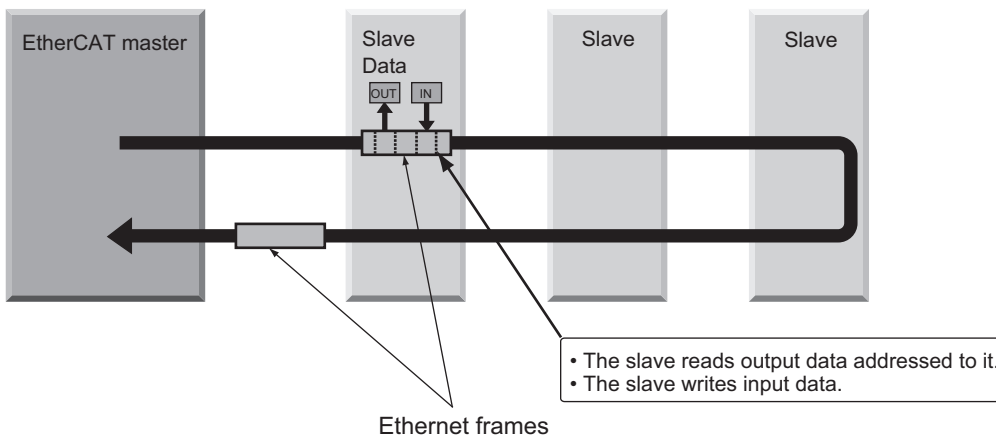

The data exchanges that are cyclically performed between the EtherCAT master and EtherCAT slaves use EtherCAT telegrams that are stored directly in the Ethernet frames. Each EtherCAT telegram consists of a telegram header (including the data length and one or more slave addresses), data, and a working counter (i.e., check bits).

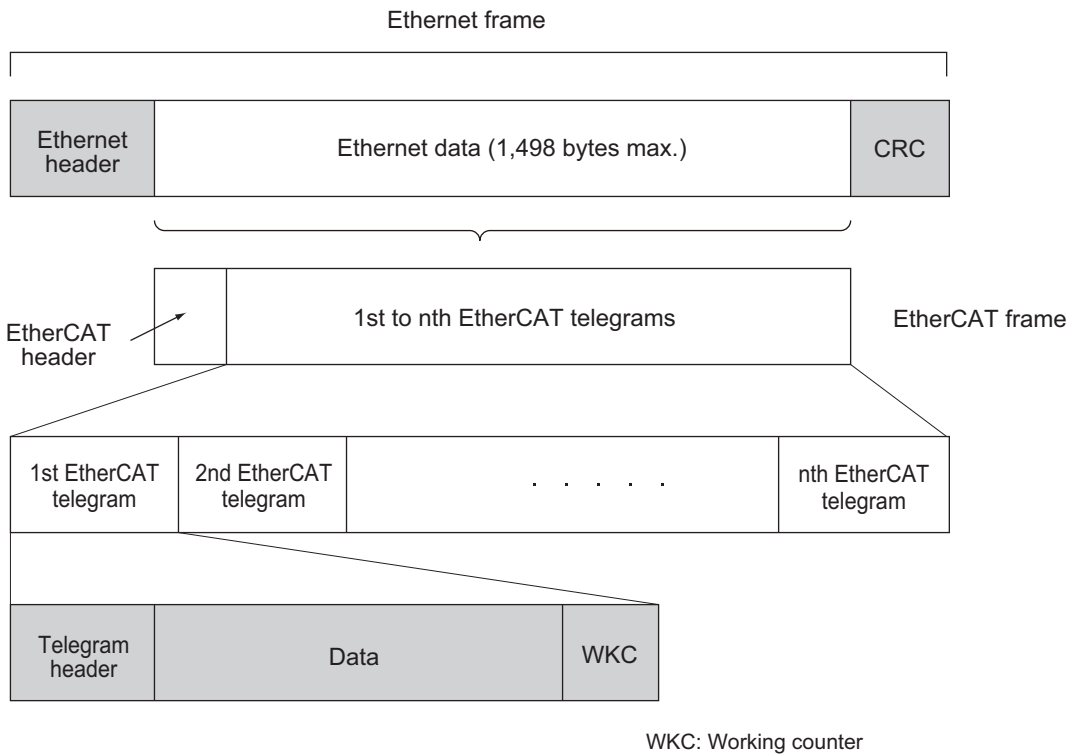

Types of EtherCAT Communications

The following 2 types of communications are available with EtherCAT.

PDO communications are executed in each EtherCAT communications cycle to refresh data continuously. SDO communications are executed between PDO communications.

Process Data Communications (PDO Communications)

The process data communication function (PDO communication) cyclically transfers process data in real-time. The EtherCAT master maps the logical process data space to the nodes to achieve cyclic communications between the EtherCAT master and slaves.

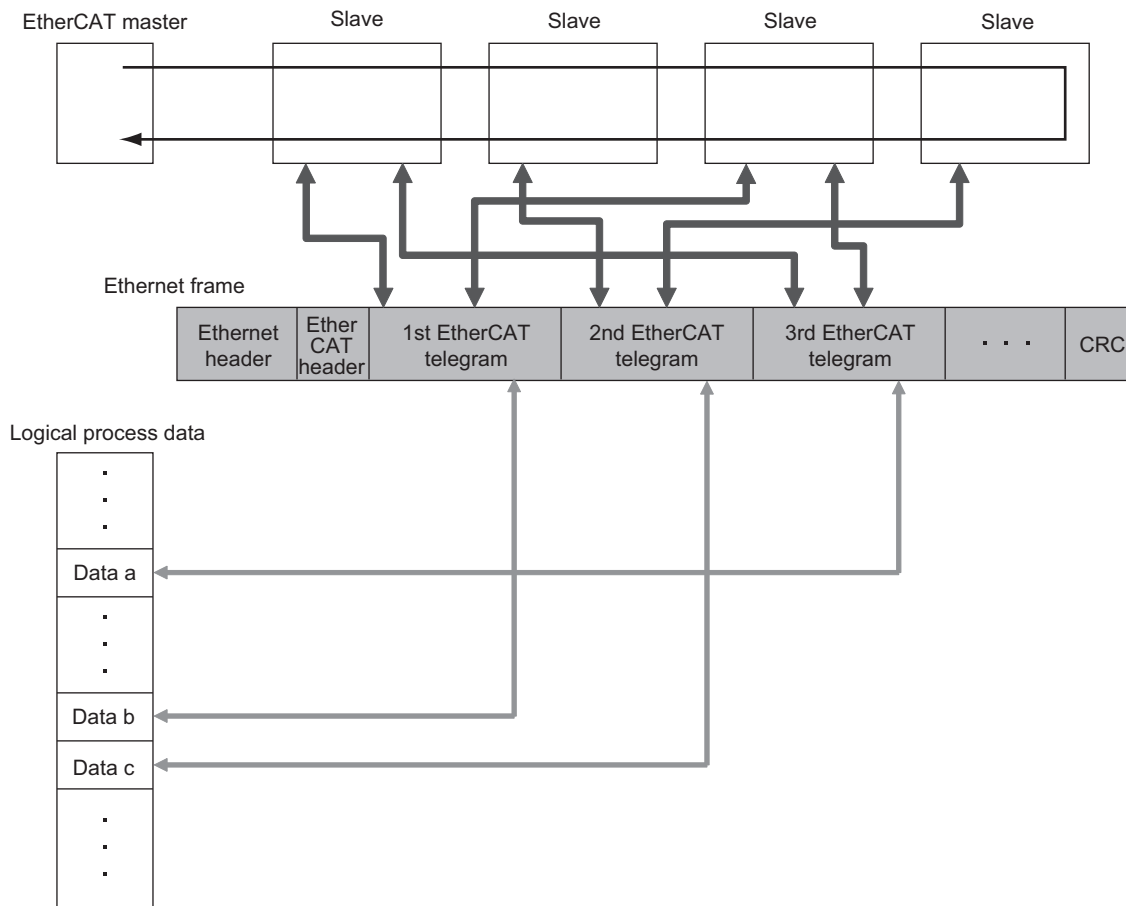

Mailbox Communications (SDO Communications)

The mailbox communication function (SDO communication) is used to perform message communication. Whenever necessary, the EtherCAT master sends a command to a slave, and then the slave returns a response to the EtherCAT master.

The mailbox communication function (SDO communication) has the following functions.

- Reading and writing process data
- Setting slaves
- Monitoring slave status

Structure of CAN Application Protocol over EtherCAT (CoE)

EtherCAT allows the use of multiple protocols for communication. The EtherCAT slave terminal uses "CAN application protocol over EtherCAT" (CoE) as the device profile for "CAN application protocol", which is an open network standard. CoE is a communication interface that is designed to provide compatibility with EtherCAT devices.

The following figure shows how the CoE is structured for an FH-series Vision Sensor.

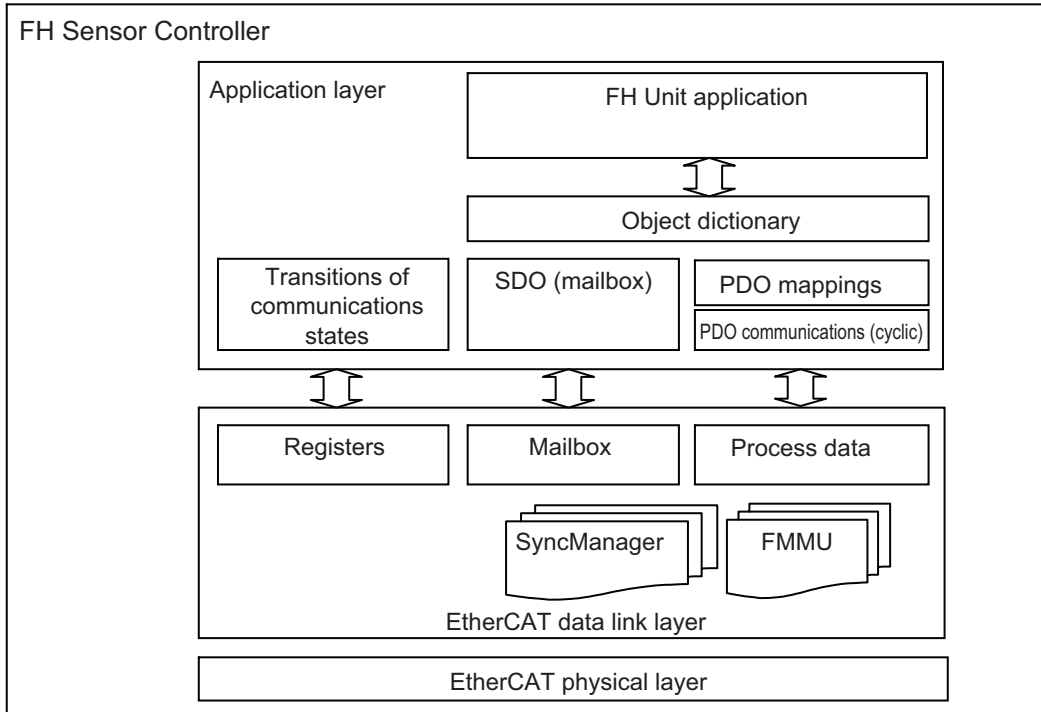

The object dictionary for the CAN application protocol is broadly divided into PDOs (process data objects) and SDOs (service data objects).

PDOs are contained in the object dictionary. The PDOs can be mapped in the object dictionary. The process data is defined by the PDO mappings. PDOs are used in PDO communications for periodic exchange of process data.

SDOs are the objects that can be read and written. SDOs are used in non-periodic SDO communications (event-driven message communications).

If you use the CoE interface to set the object dictionary for PDOs and SDOs, you can provide EtherCAT devices with the same device profiles as the CAN application protocol.

EtherCAT Slave Information Files (ESI Files)

The setting information for an EtherCAT slave is provided in an ESI file (EtherCAT slave information). The EtherCAT communications settings are defined based on the ESI files of the connected slaves and the network connection information.

You can create the network configuration information by installing ESI files into the network setup software (configuration tool).^{*1}

You can download the network configuration information to the EtherCAT master to configure the EtherCAT network.

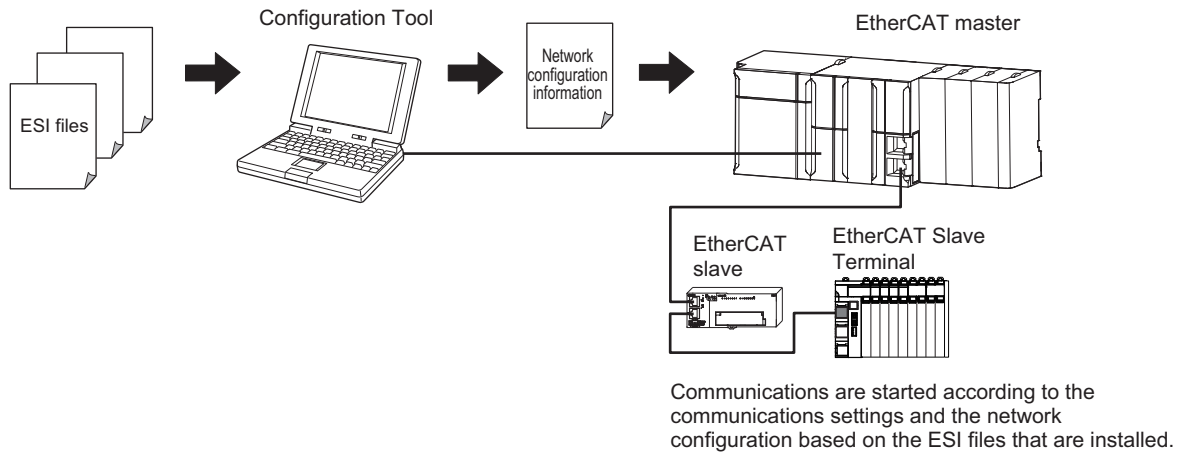

ESI files for the FH can be downloaded from the OMRON website.

*1: If you are using Sysmac Studio, it is not necessary to install the ESI files in the network setup software (configuration tool). The ESI files for OMRON EtherCAT slaves are already installed in the Sysmac Studio. You can update the Sysmac Studio to get the ESI files for the most recent models.

Transitions of Communications States

The state transition model for communications control of the EtherCAT Slave Terminals is controlled by the EtherCAT master.

The following figure shows the communications state transitions from when the power supply is turned ON.

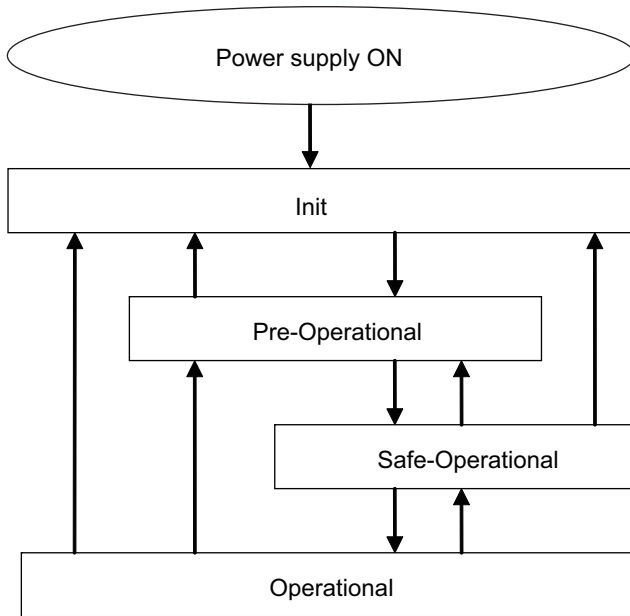

The table below shows whether or not data objects can be sent and received in each communication state.

Status	SDO communications	Sending PDOs	Receiving PDOs	Description
Init	Not possible	Not possible.	Not possible.	Communications are being initialized. Communications are not possible.
Pre-Operational	Possible.	Not possible.	Not possible.	Only SDO communications (message communications) are possible in this state. This state is entered after initialization is completed. It is used to initialize network settings.
Safe-Operational	Possible.	Possible.	Not possible.	In this state, both SDO communications (message communications) and sending PDOs are possible. Information, such as status, is sent from the Slave Terminal.
Operational	Possible.	Possible.	Possible.	This is the normal state for communications. PDO communications are used to control the I/O data.

Process Data Objects (PDOs)

This section describes the process data objects (PDO) that are used in EtherCAT communication.

Introduction

Process data objects (PDOs) are used to transfer data during cyclic communications in realtime.

There are two types of process data objects (PDOs): the RxPDOs, which are used by the EtherCAT Slave Terminal to receive data from the EtherCAT master; and the TxPDOs, which are used by the EtherCAT Slave Terminal to send data to the EtherCAT master.

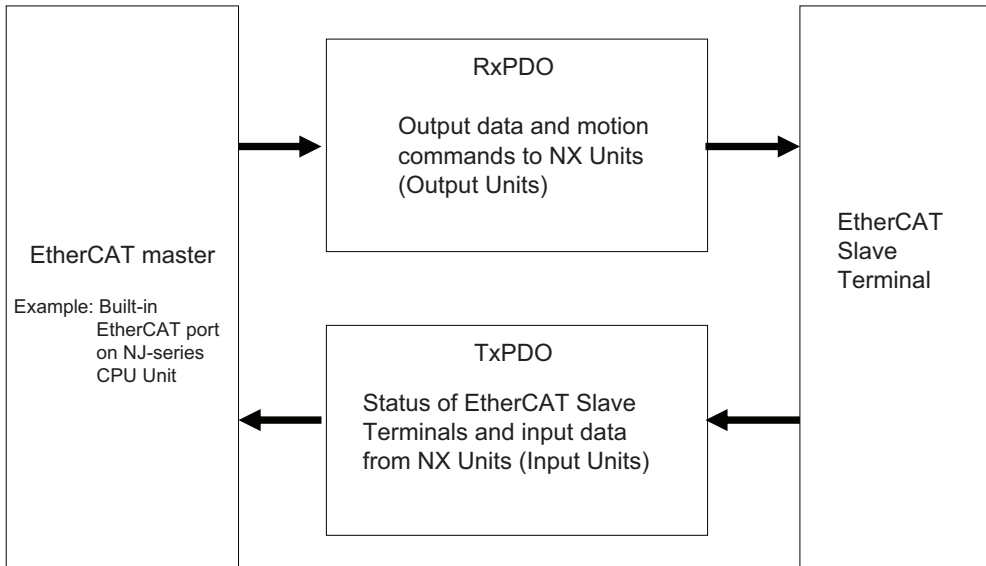

The EtherCAT application layer can hold more than one object to enable the transfer of various process data of the EtherCAT Slave Terminal.

The contents of the process data is defined in the PDO mapping objects. EtherCAT Slave Terminals support PDO mapping for I/O control.

PDO Mappings

PDO mapping objects contain the I/O data for the EtherCAT Slave Terminals. PDO mapping objects for the RxPDOs are managed in the object dictionary from indexes 1600 to 17FF hex, and for the TxPDOs from indexes 1A00 to 1BFF hex.

PDO Mapping Scheme in EtherCAT

The PDO mapping scheme in EtherCAT is described below.

Three application objects (objects A, B, and D) are allocated to the PDO (name: PDO_1) at index 1ZZZ hex. As described here, PDO mapping shows how application objects are assigned to PDOs. Indexes and subindexes are also assigned to application objects.

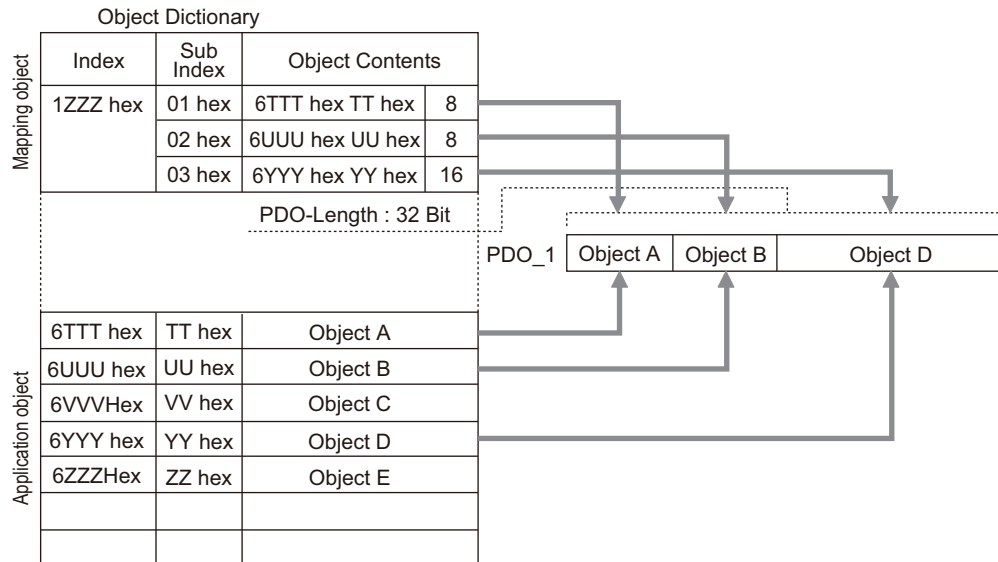

PDO Mapping with EtherCAT Slave Terminals

An EtherCAT Slave Terminal has PDOs for the FH-series Vision Sensor and each NX Unit. Application objects are assigned by default to the PDOs for each Unit.

The following diagram shows a specific example for one of the PDOs in an FH-series Vision Sensor.

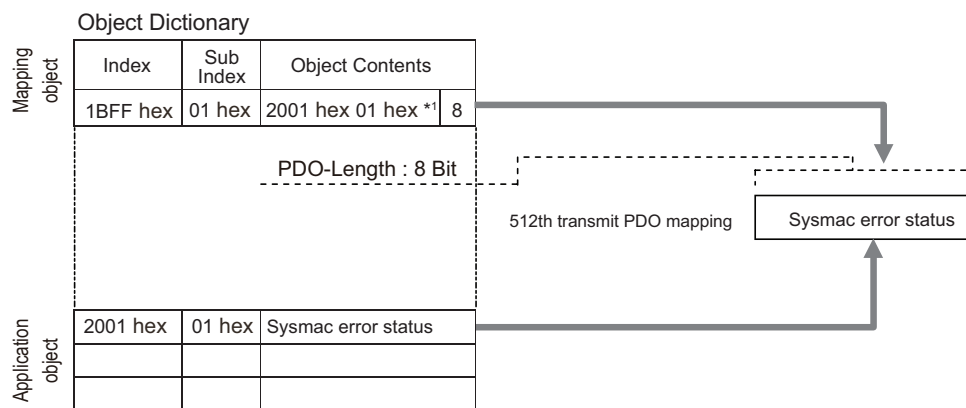

*1. This is expressed as 0x2001:01 on the Sysmac Studio.

In the previous example, a single application object is assigned to the PDO at index 1BFF hex (name: 512th transmit PDO mapping). This PDO is a TxPDO. The application object contains the Sysmac error status at index 2001 hex and subindex 01 hex.

Assigning PDOs

Scheme for Assigning PDOs to EtherCAT Slaves

You can assign more than one PDO to an EtherCAT slave.

Here, PDOs are assigned to index 1C12 hex for the RxPDO, and 1C13 hex for the TxPDO.

The following example shows how PDOs are assigned.

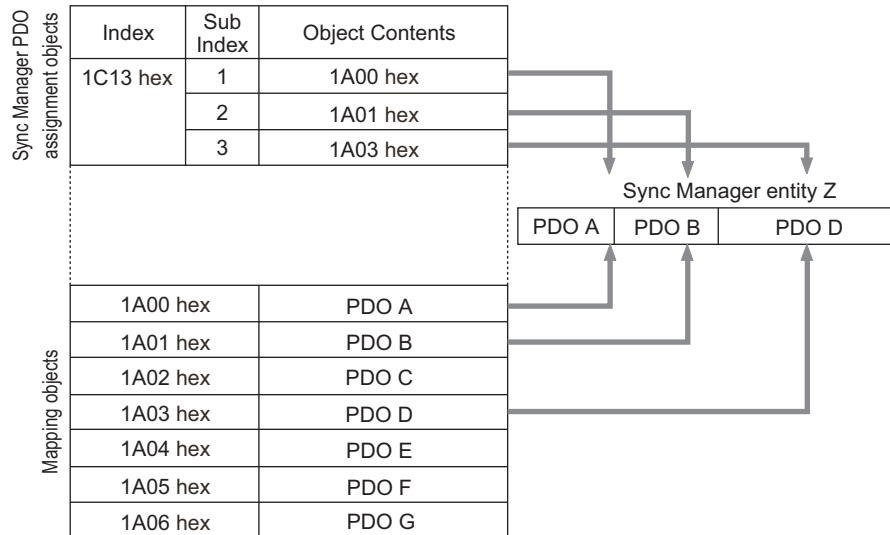

In this example, three PDOs (PDO A, PDO B, and PDO D) are assigned to index 1C13 hex (for the TxPDOs).

Similarly, a PDO (for the RxPDO) is assigned to index 1C12 hex.

These assignments determine the PDOs to use for communications between the EtherCAT master and slave.

Service Data Objects (SDOs)

This section describes the service data objects (SDO) that are used in EtherCAT communication.

Introduction

EtherCAT Slave Terminals support SDO communications.

The EtherCAT master can read and write data from and to entries in the object dictionary with SDO communications to make parameter settings and monitor status.

Refer to ► Object Dictionary Area (p.112) for the objects that you can use with SDO communications.

Abort Codes

The following table lists the abort codes for SDO communications errors.

Abort code value	Meaning
05030000 hex	Toggle bit not changed.
05040000 hex	SDO protocol timeout.
05040001 hex	Client/server command specifier not valid or unknown.
05040005 hex	Out of memory.
06010000 hex	Unsupported access to an object.
06010001 hex	Attempt to read a write-only object.
06010002 hex	Attempt to write to a read-only object.
06020000 hex	The object does not exist in the object directory.
06040041 hex	The object cannot be mapped to the PDO.
06040042 hex	Number/length of mapped objects exceeds PDO length.
06040043 hex	General parameter incompatibility.
06040047 hex	General internal incompatibility in the device.
06060000 hex	Access failed due to a hardware error.
06070010 hex	Data type does not match, length of service parameter does not match.
06070012 hex	Data type does not match, service parameter is too long.
06070013 hex	Data type does not match, service parameter is too short.
06090011 hex	Missing subindex.
06090030 hex	Value of parameter exceeded range (only for write access).
06090031 hex	Value of parameter that was written is too high.
06090032 hex	Value of parameter that was written is too low.
06090036 hex	Maximum value is less than minimum value.
08000000 hex	General error.
08000020 hex	Data cannot be transferred or stored to the application.
08000021 hex	Data cannot be transferred or stored to the application because of local control.
08000022 hex	Data cannot be transferred or stored to the application because of the present device state.
08000023 hex	Failed to dynamically create the object dictionary, or no object dictionary exists.

Communications between an EtherCAT Master and Slaves

This section describes the communications modes between the master and slaves for EtherCAT communications, and the communications modes for EtherCAT Slave Terminals.

Communications Modes for Communications between an EtherCAT Master and Slaves

Free-Run Mode (Not supported on the FH)

In free run mode, the slave processes the I/O (refreshes the I/O data) asynchronously with respect to the communications cycle of the master.

DC Mode

In DC mode, the slave processes the I/O (i.e., refreshes the I/O data) in synchronization with the communications cycle of the master. A distributed clock (DC) system whereby the master and slave share the same clock is used to synchronize EtherCAT communications. Interruptions (Sync0) are generated in the slaves at precise intervals based on this clock. Each slave executes I/O processing at this precise timing.

Communications Modes for EtherCAT Slave Terminals

The FH-series Vision Sensors support DC Mode. They do not support Free-Run Mode.

Communications Cycle

The communications cycle is determined by the setting for it in the EtherCAT master.

Refer to the ► *NJ-series CPU Unit Built-in EtherCAT Port User's Manual* (Cat. No. W505) for the communications cycles that are supported by the built-in EtherCAT ports on NJ-series CPU Units.

FH-series Vision Sensor Communications Method When Connected to EtherCAT

You can use EtherCAT communications between an EtherCAT master and Vision Sensors to control the Vision Sensors from the master with commands and responses and to output the data that results from measurements. To connect an FH-series Vision Sensor to an NJ series CPU unit by EtherCAT, use Sysmac Studio (Standard Edition) Version 1.09 or later.

The Sysmac Studio is used to register the Vision Sensors in the EtherCAT slave configuration on the [Edit Network Configuration] tab page.

Refer to ► *Section 5 Controller Configurations and Setup* in the *Sysmac Studio Version 1 Operation Manual* (Cat. No. W504) for the registration procedure.

IMPORTANT

When Sysmac Studio is used in a high load environment, such as input of measurement triggers at short intervals while connected online to an FH, there may be deviations in the measurement processing time.

Note

Up to eight FH-series Vision Sensors can be connected to an NJ-series Controller by EtherCAT.

For EtherCAT communications, the I/O ports in the following six areas in the Controller are used for communications. The I/O ports in the Sysmac Error Status Area are used only when an NJ-series CPU Unit is connected as the master.

Command/ response method	(1) I/O ports in the Command Area	You write the control commands to execute for the Vision Sensor to these I/O ports.
	(2) I/O ports in the Response Area	The FH Sensor Controller writes the results of executing the control commands that were written to the Command Area to these I/O ports.
Data output after measurements	(3) I/O ports in the Data Output Area	The FH Sensor Controller writes the measurement parameters, judgement results, and other measurement results to these I/O ports after measurements are executed.
Error status	(4) I/O ports for Sysmac Error Status Area	The FH Sensor Controller writes the error status to these I/O ports. These I/O ports function only if the Sysmac Studio and Vision Tool are used together.
User area	(5) I/O ports in the user input area	You write data that you defined for the FH Sensor Controller to these I/O ports.
	(6) I/O ports in the user output area	The FH Sensor Controller writes data that you defined for the FH Sensor Controller to these I/O ports.

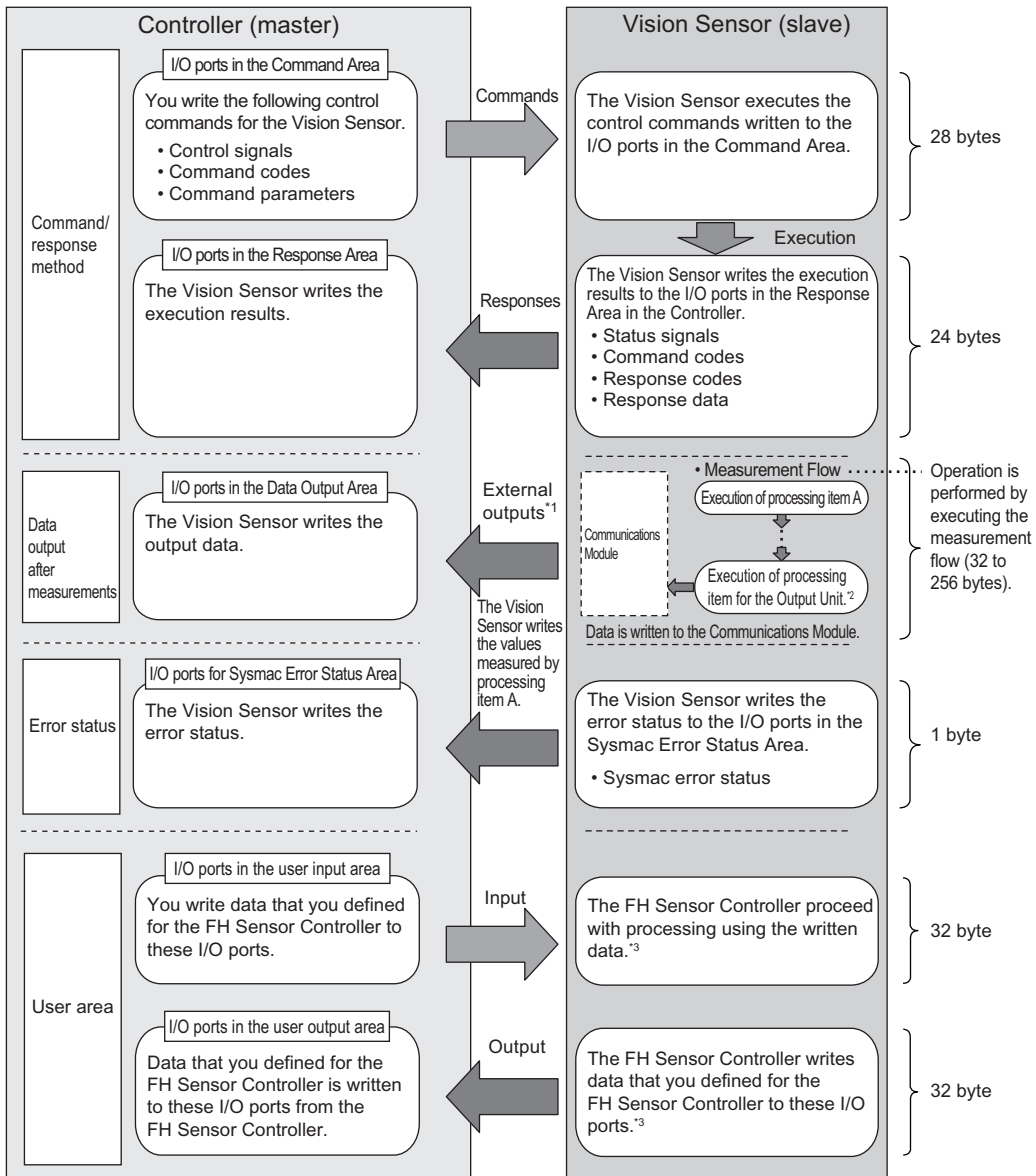

- *1: You can use output controls (handshaking) to prevent output data from being externally output from the communications buffer until the Controller (master) turns ON the Result Set Request signal to request the output data.
- *2: Refer to ► Settings Required for Data Output (p.29) for information on the Output Units that output measurement data.
- *3: Use the Macro Customization Function to input and output to the User Area.
For the Macro Customization Function, refer to ► EtherCAT communication of the IO Module List in the Vision System FH/FZ5 Macro Customize Functions Programming Manual (Cat. No. Z367).

Communications in Multi-line Random-trigger Mode

When the operation mode is multi-line random trigger mode, an FH-series Vision Sensor can be used to control up to eight lines.

When multi-line random trigger mode is used, the I/O ports (areas) for communication between the Vision Sensor and master are assigned as shown below.

Command/response method	I/O ports in the Command Area	} Assigned for each line.	
	I/O ports in the Response Area		
Data output after measurements	I/O ports in the Data Output Area		
User area	I/O ports in the User Input Area		
	I/O ports in the User Output Area		
Error status	I/O ports for Sysmac Error Status Area	 The same for all lines.

A Module (line) is assigned to each EtherCAT communications slot with the Sysmac Studio Standard Edition to allocate independent PDO communications areas for each line.

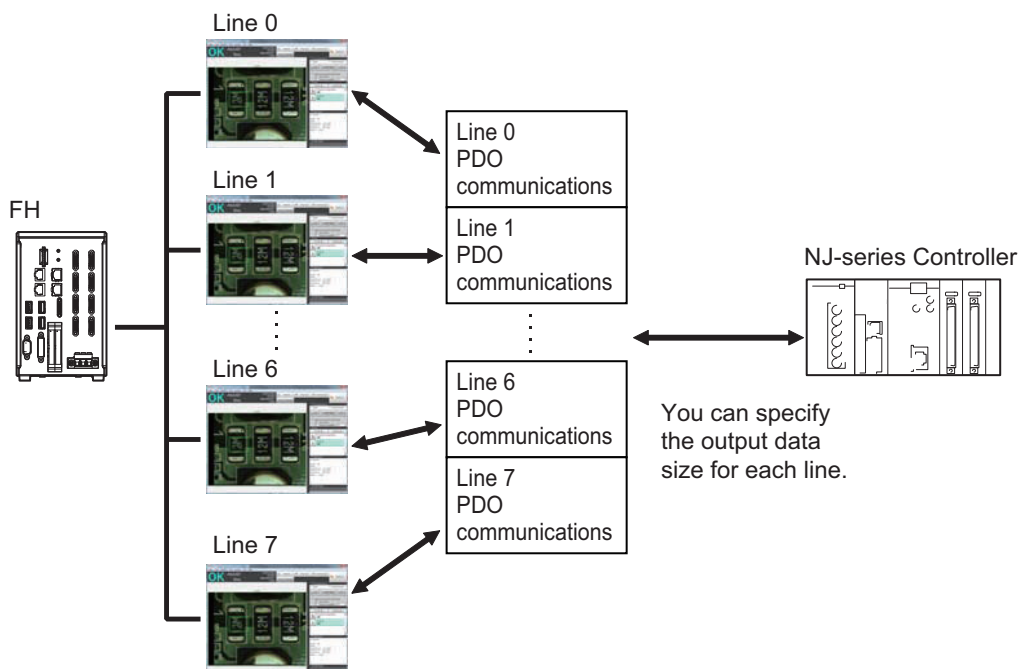

Allowable Output Data Sizes

The upper limit of the output data size will differ by number of lines in use and use of User area as shown below.

Number of lines	Don't use User area	Use User area
Line 1	Max 256 bytes	Max 256 bytes
Line 2	Max 256 bytes	Max 256 bytes
Line 3	Max 256 bytes	Max 256 bytes
Line 4	Max 256 bytes	Max 256 bytes
Line 5	Max 256 bytes	Max 128 bytes
Line 6	Max 128 bytes	Max 128 bytes
Line 7	Max 128 bytes	Max 128 bytes
Line 8	Max 128 bytes	Max 128 bytes

Minimum PDO Communications Cycle Time

Do not set the communication cycle (PDO communication cycle time) for EtherCAT communication to a value lower than the applicable minimum time given in the following table.

The minimum communication cycle (PDO communication cycle time) depends on the Data output byte size and the use of the User area differs with the Number of controlled lines, as shown below. When multi-line random trigger mode is used, the minimum communication cycle is the minimum value of the maximum byte size for each line.

If the Communication cycle (PDO Communication cycle time) is set lower than the minimum value below, an exception (AL status code: 0x0035) will occur and EtherCAT communications will be lost.

• Do not use the User area:

Number of controlled lines	Data output byte size			
	32 bytes	64 bytes	128 bytes	256 bytes
1 line	125 μ s			250 μ s
2 lines	250 μ s			
3 lines	250 μ s		500 μ s	
4 lines	500 μ s			
5 lines	500 μ s			1,000 μ s
6 lines	500 μ s		1,000 μ s	Not supported.
7 lines	500 μ s		1,000 μ s	Not supported.
8 lines	1,000 μ s			Not supported.

• Use the User area

Number of controlled lines	Data output byte size			
	32 bytes	64 bytes	128 bytes	256 bytes
1 line	125 μ s		250 μ s	
2 line	250 μ s			500 μ s
3 line	500 μ s			
4 line	500 μ s			1,000 μ s
5 line	500 μ s		1,000 μ s	Not supported.
6 line	1,000 μ s			Not supported.
7 line	1,000 μ s			Not supported.
8 line	1,000 μ s		Not supported.	

Applicable Models

- **OMRON**

○: Can connect △: Only some models can connect ---: Cannot connect

Series	CPU	Interface	
		Direct connection with CPU unit (built-in port)	Connection via master unit
SYSMAC NJ/NX	NJ501 NJ301 NJ101 NX701	○	---

- **Beckhoff**

TwinCAT PC Edition, Industrial PCs, and Embedded PCs

*1: You must obtain an ESI file for the FH-series Vision Sensor from OMRON to use a Beckhoff master.

Communications Settings

The following settings are required to use EtherCAT communications.

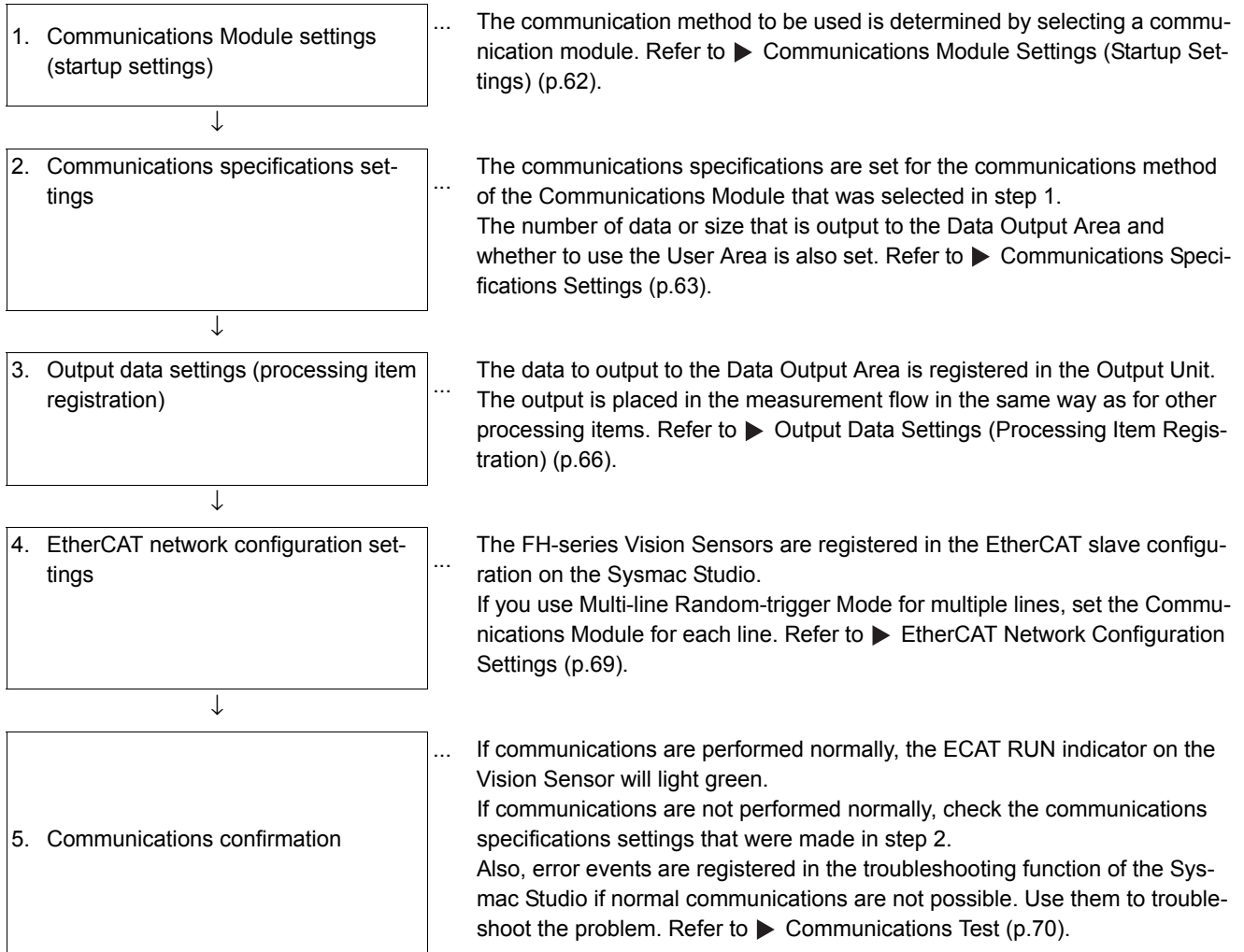

Note

Communications are set up as shown below when you use the multi-line random-trigger mode.

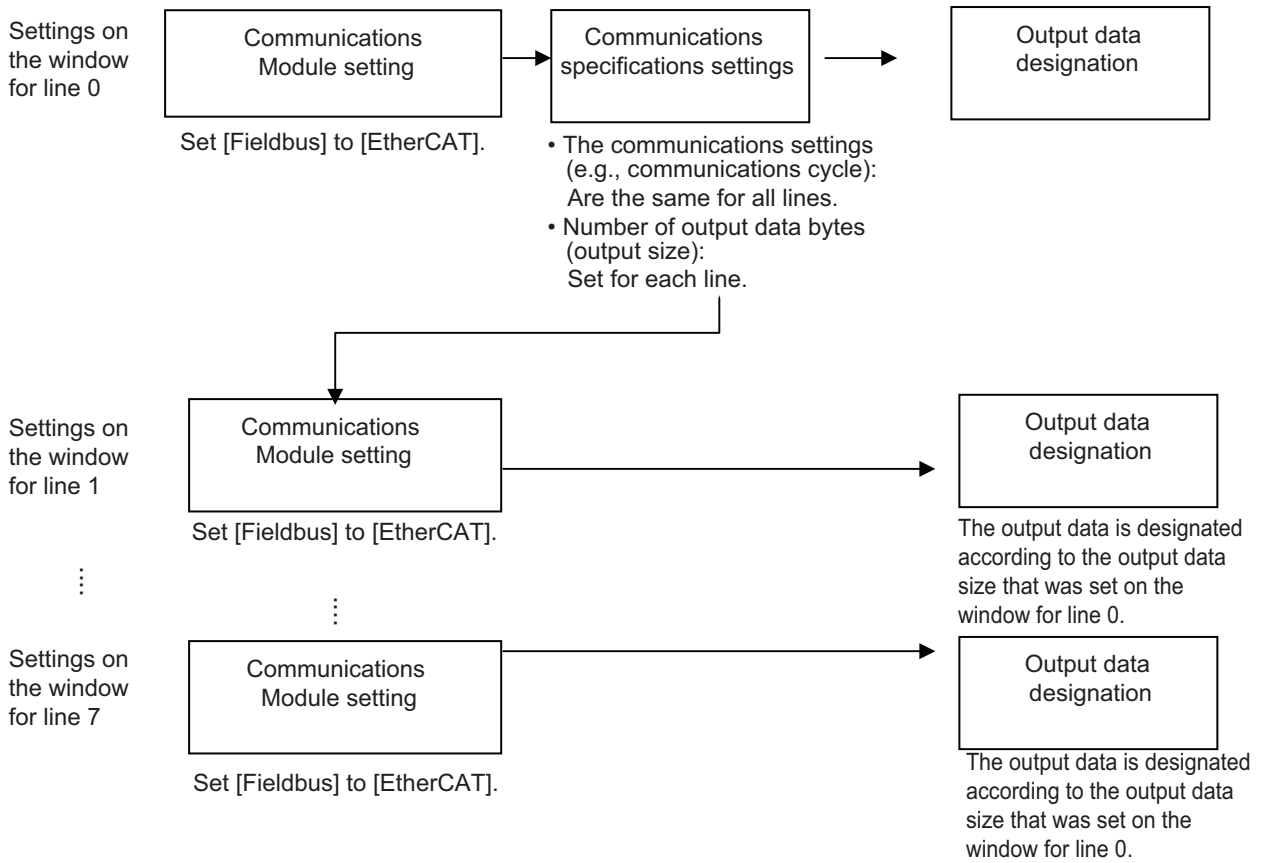

Communications Module Settings (Startup Settings)

The communication method used for communication with the Sensor Controller is selected from the communication modules.

- 1 On the Main Window, select [Tool] – [System Settings].
- 2 Select [System setting] – [Startup] – [Startup setting] on the Multiview Explorer on the left and then click the [Communication] button.

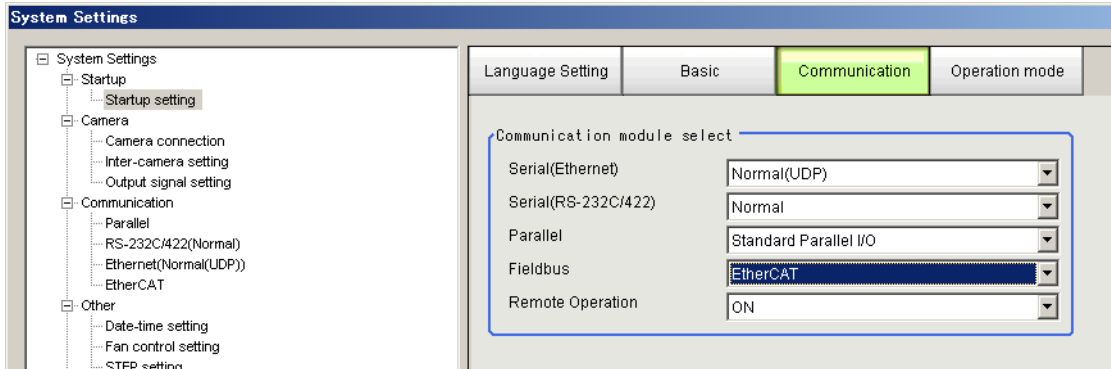

- 3 In the Communications Module Selection Area, select [EtherCAT] in the [Fieldbus] box and then click the [Apply] button.
- 4 Click the [Data save] button in the Toolbar.



- 5 On the Main Window, select [Function] – [System restart].
Click the [Apply] button in the [System Restart] dialog box to restart the Sensor Controller.
- 6 When the Sensor Controller has been restarted, operation will be performed for the default settings of the specified Communications Module.
Set the communications settings according to the PLC or other external device.

IMPORTANT

If you will use the multi-line random-trigger mode for EtherCAT communications for multiple lines, use the following procedure to set the Communications Module.

- (1) In the Communications Module settings for line 0, set the **Fieldbus** Box to *EtherCAT*, save the setting to the Vision Sensor, and then restart the system.
- (2) After the system has been restarted, set the **Fieldbus** Box to *EtherCAT* in the Communications Module settings for line 1, save the setting to the Vision Sensor, and then restart the system. Repeat this step for the rest of the lines.

Note

You can save the Communications Module settings to a file.

Use the **System data** or **System + Scene group 0 data** option for saving settings to a file.

Refer to: ► *Saving Settings Data to the Controller RAM Disk or an External Memory Device* in the *Vision System FH/FZ5 Series User's Manual* (Cat. No. Z365).

Communications Specifications Settings

You must set the data output size, output handshaking, and output controls for EtherCAT communications.

IMPORTANT

- Use the same communications specifications settings for the Sensor Controller and the external device.
- Do not input signals to EtherCAT from an external device while setting the EtherCAT system settings.
- Before you set the communications specifications, set the Communications Module to EtherCAT.

Restart the system after you save the data to the Vision Sensor.

Reference: ► Communications Module Settings (Startup Settings) (p.62)

2

Methods for Connecting and Communicating with External Devices

- 1 On the Main Window, select [Tool]– [System Settings].**
- 2 Select [System Settings] and then select [Communications] – [EtherCAT].**
The tab page for the communications settings is displayed.
- 3 Set up the following items.**

The screenshot shows the 'Setting' tab of the Communications Specifications Settings window. The settings are as follows:

Setting	Value	
Output control :	None	
Output period [ms] :	2	
Output time [ms] :	1	
Timeout [s] :	10.0	
Data output number :		
User Area		
Line0	Result Data Format 0(DINT 8)	OFF
Line1	Result Data Format 0(DINT 8)	OFF
Line2	Result Data Format 0(DINT 8)	OFF
Line3	Result Data Format 0(DINT 8)	OFF
Line4	Result Data Format 0(DINT 8)	OFF
Line5	Result Data Format 0(DINT 8)	OFF
Line6	Result Data Format 0(DINT 8)	OFF
Line7	Result Data Format 0(DINT 8)	OFF

Setting item	Set value [Factory default]	Description	
Output control	(None) Handshaking	None	This setting is used to output the measurement results asynchronously with the external device.
		Handshaking	This setting is used to output the measurement results synchronously with the external device.
Output period [ms]	2 to 5,000 cycles (2 cycles)	Set the timing for outputting the measurement results. Set the number of cyclic communications of the EtherCAT PDO communications cycle after which to output the measurement results from the Sensor Controller.	
Output time [ms]	1 to 1,000 cycles (1 cycle)	Set the time to hold the output of the measurement results. Set the number of EtherCAT PDO communications cycles to hold the output from the Sensor Controller.	
Timeout [s] (When [Output Control] is set to [Handshaking])	0.5 to 120.0 s (10.0 s)	Set the timeout time. A timeout error occurs if the external device does not perform handshaking during the set time.	
Line n Data Output number (number of data outputs for line n)	Result Data Format 0 (DINT 8) Result Data Format 1 (DINT 16) Result Data Format 2 (DINT 32) Result Data Format 3 (DINT 64) Result Data Format 4 (LREAL 4) Result Data Format 5 (LREAL 8) Result Data Format 6 (LREAL 16) Result Data Format 7 (LREAL 32) Result Data Format 8 (DINT 2 + LREAL 3) Result Data Format 9 (DINT 4 + LREAL 6) Result Data Format 10 (DINT 8 + LREAL 12) Result Data Format 11 (DINT 16 + LREAL 24)	Set number of data items to output for each line. There are two data sizes that are used for the output data: 4 bytes (DINT) and 8 bytes (LREAL). Select the output data sizes and number of outputs from the following selections.	
		Result Data Format 0 (DINT 8)	Eight 4-byte data items are output. (Total: 32 bytes)
		Result Data Format 1 (DINT 16)	Sixteen 4-byte data items are output. (Total: 64 bytes)
		Result Data Format 2 (DINT 32)	Thirty-two 4-byte data items are output. (Total: 128 bytes)
		Result Data Format 3 (DINT 64) ^{*1}	Sixty-four 4-byte data items are output. (Total: 256 bytes)
		Result Data Format 4 (LREAL 4)	Four 8-byte data items are output. (Total: 32 bytes)
		Result Data Format 5 (LREAL 8)	Eight 8-byte data items are output. (Total: 64 bytes)
		Result Data Format 6 (LREAL 16)	Sixteen 8-byte data items are output. (Total: 128 bytes)
		Result Data Format 7 (LREAL 32) ^{*1}	Thirty-two 8-byte data items are output. (Total: 256 bytes)
		Result Data Format 8 (DINT 2 + LREAL 3)	Two 4-byte data items and three 8-byte data items are output, for a total of 5 data items. (Total: 32 bytes)
		Result Data Format 9 (DINT 4 + LREAL 6)	Four 4-byte data items and six 8-byte data items are output, for a total of 10 data items. (Total: 64 bytes)
		Result Data Format 10 (DINT 8 + LREAL 12)	Eight 4-byte data items and twelve 8-byte data items are output, for a total of 20 data items. (Total: 128 bytes)
Result Data Format 11 (DINT 16 + LREAL 24) ^{*1}	Sixteen 4-byte data items and twenty-four 8-byte data items are output, for a total of 40 data items. (Total: 256 bytes)		
User area	(OFF) ON	Set whether or not to use the user area (user input area/user output area) for each line.	

*1: If you control from six to eight lines in the multi-line random-trigger mode, you cannot use the 256-byte data output sizes.

4 Click the [Apply] button.

IMPORTANT

If you change any of the [Line N Data Output Number] and [User area] settings, restart the Controller.

Note

If you use alignment, select the data type of the output data according to the application.

- DINT Data
This data type holds a single-precision floating-point number.
Coordinate values are multiplied by 1,000 and are output as integers.
Only 1/1,000 of the precision is output.
- LREAL Data
This data type holds a double-precision floating-point number.
If you use alignment, coordinate values are output as double-precision floating-point numbers.
This allows you to output the actual values to an external device.
However, processing 64-bit calculations on the NJ-series Controller or other PLC will be slower than processing 32-bit calculations.

EtherCAT Communications Settings for Multi-line Random-trigger Mode

If you will use the multi-line random-trigger mode for EtherCAT communications for multiple lines, you can set the EtherCAT communications settings only on the setting tab page for line 0.

The EtherCAT communications settings for multiple lines are given in the following table.

Setting item	Description
Output control	The same setting is used for all lines.
Output period	The same setting is used for all lines.
Output setting	Set for each line. The Fieldbus data output setting for each line depends on the Data Output Number setting. Refer to ► Output Data Settings (Processing Item Registration) (p.66).

Output Data Settings (Processing Item Registration)

Use the following procedures to set the items to output to EtherCAT and the output format.

Registering Processing Items

Register the processing items for data output in the measurement flow.

- 1 Click the [Edit flow] button in the Toolbar.
- 2 Select the [Fieldbus Data Output] processing item from the processing item tree.

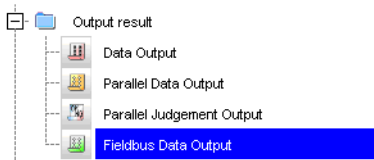

- 3 Click the [Append] button.

The [Fieldbus Data Output] processing item is appended at the bottom of the unit list (flow).

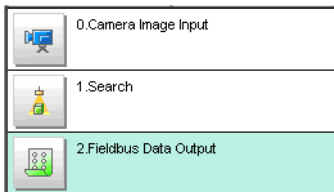

- 4 Click the [Fieldbus Output] () icon and set the data output items and data format.

Refer to the following references for details on the settings.

Reference: ► Setting the Output Data (p.68)

IMPORTANT

Fieldbus Data Output

Specify the Communication setting before setting of Fieldbus Data Output.

Note that if you change the Communication settings after setting of Fieldbus Data Output, the changed settings are not displayed on the Fieldbus Data Output setting display.

Note

-
- Depending on the Data Output Number setting for the line, you can set from 4 to 64 data items for output with one data output processing item.
Examples:
DINT16: You can register up to 16 data items.
LREAL 24: You can register up to 24 data items.
Refer to ► Communications Specifications Settings (p.63) for the number of data items that you can output for each Data Output Number setting.
If you need to output more data items than given above, use more than one Output Unit.
However, the data is output to the same destination, so if you do not control the output, the output data that was output first will be overwritten by the output data that is output after it.
Use the following method to read each set of output data.
 - Controlling Data Output with Handshaking
If handshaking is used to control data output, the timing of outputting the data is controlled by I/O signals.
Each time that data is output, read the output data and move it to a different part of I/O memory in the PLC.
Refer to ► Data Output Control with Handshaking (p.32) for more information on handshaking.
 - Data is output in the order of registration in the measurement flow, with each data output processing item executed at a different timing. (Data output is executed in the order that it is registered in the measurement flow.) Reference: ► Outputting the Output Data (p.27)
-

Setting the Output Data

Set expressions for the data to output.

Expressions are set for both 4-byte data (DINT) and 8-byte data (LREAL).

Note

The Fieldbus Data Output setting item changes according to the EtherCAT communications settings. Set the total output data size (256 bytes max.) and the number of data items to output (64 max.) in the EtherCAT communications settings in advance.

- 1 Click the Fieldbus Data Output Icon () in the measurement unit list (flow).**
- 2 The Fieldbus Data Output Window is displayed.**

The following tabs are displayed: [DINT Setting] and [LREAL Setting]. The output data numbers are displayed according to the EtherCAT communications settings.
- 3 Click the [DINT Setting] or [LREAL Setting] tab.**

The [DINT Setting] or [LREAL Setting] tab page is displayed according to the EtherCAT communications settings.
- 4 In the list, select the output data number for the expression to set.**

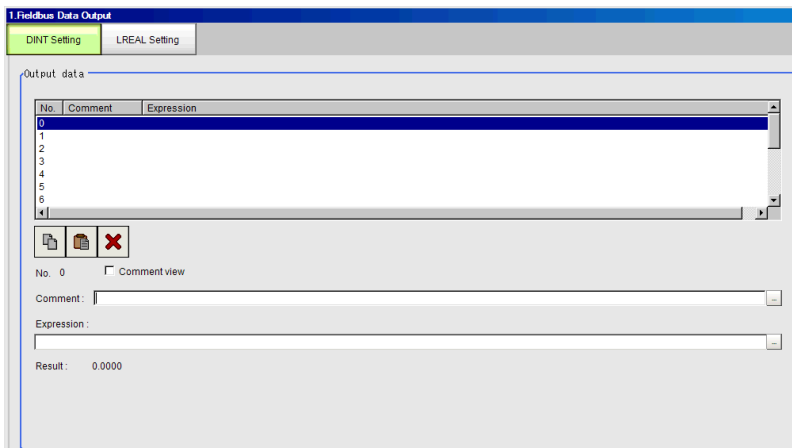

The selected output data number is displayed under the list.

- 5 Click the [...] button next to the expression box and set the expression.**

For calculation settings, refer to section of Calculation in *FH/FZ5 Processing Item Function Reference Manual* (Cat. No. Z341).



Specify the processing items, measurement results, and measurement data in the expression. You can also perform arithmetic or function calculations on the measurement data before it is output.

- 6 Click the [...] button for the [Comment] box and enter an explanation of the expression.**

The comment you enter will be displayed in the detailed results on the Main Window. For example, if you enter "Test" as the comment for expression 0, "Test" will be displayed in place of "Expression 0" in the detailed results area on the Main Window.
- 7 Repeat steps 4 and 5 to set expressions for all of the required output data numbers.**
- 8 Click the [DINT Setting] or [LREAL Setting] tab and then set expressions in the same way as for steps 3 to 5, above.**

Note

If you delete one of the expressions that is set for an output data number, 0 is output for the output data for that number.

EtherCAT Network Configuration Settings

To connect FH-series Vision Sensors to an NJ-series Controller, you must use the Sysmac Studio to register the Vision Sensors in the network configuration.

IMPORTANT

To connect FH-series Vision Sensors to an NJ/NX series Controller, you must place the Sysmac Studio online with the Vision Sensors in the EtherCAT network configuration.

Registering the Vision Sensors in the EtherCAT Slave Configuration

Register the Vision Sensors in the EtherCAT slave configuration on the [Edit Network Configuration] tab page. Refer to ► *Section 5 Controller Configurations and Setup* in the *Sysmac Studio Version 1 Operation Manual* (Cat. No. W504) for the registration procedure.

IMPORTANT

Use Sysmac Studio Standard Edition version 1.09 or higher to set up the EtherCAT connections between FH-series Vision Sensors and an NJ-series Controller.

Setting the Data Output Sizes

Use the Sysmac Studio to assign PDO communications areas for each line in the master according to the Data Output Number settings in the EtherCAT communications specifications settings. There are the following two setting methods.

Online settings

If the data output sizes are already set in the Vision Sensors, use the following procedure to make the settings in the Sysmac Studio.

- 1 Place the Sysmac Studio online with a Vision Sensor.**
- 2 Take the Vision Sensor offline. The settings from the Vision Sensor will be loaded to the Sysmac Studio.**
- 3 PDO communications areas will also be assigned in the master according to the EtherCAT communications specifications settings.**

Offline settings

To set the data output sizes on the Sysmac Studio when they are not yet set in the FH-series Vision Sensors, use the following procedure offline.

- 1 Display the window to edit the FH-series system data.**
- 2 Display the EtherCAT Settings Window and select the check boxes for the EtherCAT settings.**
- 3 Restart the FH Simulator to enable the settings.**
- 4 After the Simulator is restarted, display the EtherCAT Settings Window and set the Data Output Number for each line.**
- 5 Restart the FH Simulator to enable the settings.**

PDO communications areas will also be assigned in the master according to the EtherCAT communications specifications settings.

Note

If you change any parameter that requires that the Vision Sensor be restarted,  will be displayed by the model in the Multiview Explorer. If this icon is displayed, restart the Vision Sensor.

IMPORTANT

If six to eight lines are controlled in multi-line random trigger mode, settings where the data output size (data output number) is 256 bytes*1 cannot be used. If a 256-byte data output size is set, a warning mark will appear in Sysmac Studio.

*1: Three types: "Result Data Format 3 (DINT 64)", "Result Data Format 7 (LREAL 32)", "Result Data Format 11 (DINT 16 + LREAL 24)"

Communications Test

You can check whether the EtherCAT communications settings are correct.

If communications are performed normally, the ECAT RUN indicator on the Vision Sensor will light green.

If communication does not take place normally, check the communication specification settings.

An error log is recorded in Troubleshooting in Sysmac Studio. Use the error log to help resolve the problem.

Refer to ► Sysmac Error Status Event Code Table (p.96).

Note

For LED specifications of ECAT RUN-LED of FH series Sensor Controller, refer to *3-1 Sensor Controller in Vision System FH/FZ5 series Hardware Setup Manual (Z366)*.

I/O Ports by Area (PDO Mapping) and Memory Assignments

This section describes the I/O ports in the Command, Response, Data Output, User Area, and Sysmac Error Status Areas.

Refer to the following section for the sizes, data types, default values, and other information on the I/O ports.

Reference: ► Vision Sensor Specific Objects (p.152)

Command Area I/O Ports

Controller (Master) to Vision Sensor (Slave)

I/O port name	Signal name	Function
Control Flag	Control Signals	
Command Request	Command Request	Switches from OFF to ON when the Controller (master) instructs the sensor controller (slave) to execute the control command. (Switches from OFF to ON when setting of the control command code and parameter is completed.)
		Switched from ON back to OFF by the Controller (master) when the Command Completion signal from the Sensor Controller (slave) turns ON.
Trigger	Measurement Trigger	Switches from OFF to ON when the Controller (master) requests measurement execution.
		This signal returns to OFF when the Trigger Acknowledged signal goes ON.
Flow Command Request	Flow Command Request	Turn ON this signal to request execution of a command that was input during execution of the fieldbus flow control.
		Switched from ON back to OFF when the Flow Command Completion signal turns ON.
Error Clear	Clear Error	Switches from OFF to ON to turn OFF the Sensor Controller (slave) Error Status signal.
		Switches back to OFF when the Error Status signal from the Controller (master) turns OFF.
Result Set Request	Data Output Request *1: Used only when output handshaking is enabled.	Switches from OFF to ON when the Controller (master) requests data output. After receiving a data output request, the Sensor Controller (slave) outputs the data.
		Switches from ON back to OFF by the Controller (master) when the Result Notification signal from the Sensor Controller (slave) turns ON.
Command Code	Command code	This I/O port stores the command code.
Command Parameter 0 to 3	Command parameters	These I/O ports store the command parameters.

IMPORTANT

Command Parameter 3 cannot be used in the reserved area. Use Command Parameter 0 to 2.

Response area I/O port

Vision Sensor (Slave) to Controller (Master)

I/O port name	Signal name	Function
Vision Status Flag	Status Signals	
Command Completion	Command Completion	Switches from OFF to ON when the Sensor Controller (slave) completes execution of the control command and stores the control command code, response code, and response data. Automatically switches from ON to OFF when the Command Request signal from the Controller (master) turns from ON to OFF.
BUSY	Busy	Turns ON if execution of the control command by the Sensor Controller (slave) is not possible. Turns OFF if execution of the control command by the Sensor Controller (slave) is possible.
Trigger Ready	Trigger Ready	Turns OFF if the Sensor Controller (slave) cannot accept the measurement trigger. When the image window is set to [Through], the trigger input enabled state (Trigger Ready) signal turns OFF. Measurement is possible in this case. Turns ON if the Sensor Controller (slave) can accept the measurement trigger.
Total Judgment	Overall Judgement Output	This signal turns ON when the overall judgement is NG. This signal turns OFF when the overall judgement is OK.
Run Mode	Run Mode	Turns ON when the Sensor Controller (slave) is in Run mode. Turns OFF when the Sensor Controller (slave) is not in Run mode
Trigger Ack	Trigger Acknowledged	This signal turns ON when the Vision Sensor receives a Trigger signal. This signal automatically turns OFF when the Trigger signal turns OFF.
Command Ready	Command Ready	This signal turns ON when control command execution is possible. This signal turns OFF when control command execution is not possible.
Shutter Output	Shutter Trigger Output	This signal turns ON when the sensing elements have completed exposure. This signal turns OFF after one output period of EtherCAT communications.
Flow Command Completion	Flow Command Completion	Turns ON after the Sensor Controller (slave) echoes back the executed command code, and sets the response code and response data during Fieldbus Flow command execution. Turns OFF after checking that the Flow Command Request signal is OFF.
Flow Command Busy	Flow Command Busy	This signal is ON when a command that was input during execution of the fieldbus flow control is being executed. Turns OFF after completion of the executed command.
Flow Command Wait	Flow Command Wait	This signal is ON when a command can be input during execution of the fieldbus flow control. This signal is OFF when a command cannot be input during execution of the fieldbus flow control.
Error Status	Error Signal	Turns ON if the Sensor Controller (slave) detects an error. Turns OFF if the Sensor Controller (slave) runs normally.

I/O port name	Signal name	Function
Status Flag	Status Signal	
Result Notification	Data Output Completion	<p>Switches from OFF to ON when the Sensor Controller (slave) completes data output.</p> <ul style="list-style-type: none"> • No Handshaking This signal turns OFF after the output time that is set in the EtherCAT settings has elapsed. • Using Handshaking Automatically switches from ON to OFF by the Controller (master) when the Result Set Request signal from the Controller (master) turns from ON to OFF.
Command Code Echo Back	Command echo code	This I/O port returns the command code that was executed.
Response Code	Response code	This I/O port contains the response code of the executed command.
Response Data	Response data	This I/O port contains the response data of the executed command.
Error Code	Error Code	The event code for the Sysmac error status is stored here when an error occurs. Refer to ► Reference: Sysmac Error Status (p.96) for the event codes.

I/O Ports in the Data Output Area

Sensor Controller (Slave) to Controller (Master)

I/O port name	Signal name	Data output number	Function
DINT Result Data 0 to 63	Output data 0 to 63	1 (4 bytes) to 64 (256 bytes)	The pattern that is set for the Data Output Number setting in the communications settings is output.
LREAL Result Data 0 to 31	Output data 0 to 31	1 (8 bytes) to 32 (256 bytes)	<p>Example: If the Data Output Number is set to 32 bytes <i>DINT</i> 2 + <i>LREAL</i> 3, the I/O ports would be assigned as follows:</p> <p>DINT Result Data 0 DINT Result Data 1 LREAL Result Data 0 LREAL Result Data 1 LREAL Result Data 2</p>

I/O ports in the User Input Area

PLC (master) to FH Sensor Controller (slave)

I/O port name	Signal name	Data type	Function
User Input Area 0	User Input Area 0	DINT	In the Communication specification settings, if you select [ON] for the User area setting, you can use the User area using Macro Customize, as the input area to the Sensor Controller to freely write data to.
User Input Area 1	User Input Area 1	DINT	
User Input Area 2	User Input Area 2	DINT	
User Input Area 3	User Input Area 3	DINT	
User Input Area 4	User Input Area 4	LREAL	
User Input Area 5	User Input Area 5	LREAL	

I/O ports in the User Output Area

FH Sensor Controller (slave) to PLC (master)

I/O port name	Signal name	Data type	Function
User Output Area 0	User Output Area 0	DINT	In the Communication specification settings, if you select [ON] for the User area setting, you can use the User area using Macro Customize, as the output area to the Sensor Controller to freely write data to.
User Output Area 1	User Output Area 1	DINT	
User Output Area 2	User Output Area 2	DINT	
User Output Area 3	User Output Area 3	DINT	
User Output Area 4	User Output Area 4	LREAL	
User Output Area 5	User Output Area 5	LREAL	

I/O Ports in Sysmac Error Status Area

Vision Sensor (Slave) to Controller (Master)

The Sysmac Error Status is mapped only when connected to an NJ-series Controller.

Sysmac Studio Standard Edition version 1.09 or higher is required.

I/O port name	Signal name	Function
Sysmac Error Status	Sysmac Error Status	Gives the Sysmac error status.
Observation	Observation Error	Turns ON if an observation error occurs in the Sensor Controller (slave).
Minor Fault	Minor Fault Level Error	Turns ON if a minor fault level error occurs in the Sensor Controller (slave).

Rules for I/O port names

An I/O port name consists of the device name and controlled line number, as shown below.

If only one line is controlled, the line number is given as "Line0."

Example: Command Request Signal in the Command Area

E001_Line0_Command Request

• Device name

When the operation mode is multi-line random trigger mode, the I/O ports of the Command Area, Response Area, and Data Output Area are assigned separately for each line. The I/O ports in the Sysmac Error Status Area are shared by all lines.

Line used	I/O port	
	When the operation mode is not multi-line random trigger mode	When the operation mode is multi-line random trigger mode (Example: When the number of lines is 3)
Line 0	E001_Line0_Command_Request	E001_Line0_Command_Request
Line 1	---	E001_Line1_Command_Request
Line 2	---	E001_Line2_Command_Request

I/O Signals

The following tables list the signals that are used to control I/O for EtherCAT.

Input Signals

Signal	Signal name	Function	ON/OFF timing	
			OFF to ON	ON to OFF
Command Request	Command Execution	Turn ON this signal (from the PLC) to send a command to the Vision Sensor.	Turn ON the signal (from the PLC) to send a command to the Vision Sensor and request execution based on the command code and command parameters.	Switched from ON back to OFF by the user (PLC) when the Command Completion signal from the FH turns ON.
Result Set Request (Used only for handshaking output control.)	Data Output Request	<p>During handshaking, send this signal from the PLC to the Vision Sensor to request the external output of the data output results from the execution of the measurement flow.</p> <p>If this signal is ON when an Output Unit (Fieldbus Data Output Unit) in the measurement flow is executed, the Vision Sensor will output the data from the processing item. If multiple output units are used to output more than 256 bytes of output data, turn ON the Result Set Request signal again after the Result Notification signal for the first data output turns OFF.</p> <p>Refer to ► Time Charts (p.90).</p>	<ul style="list-style-type: none"> • Turn ON the signal (from the PLC) to externally output the data that results from measurement.*2 • This Result Set Request signal is turned ON at the same time that the Trigger signal or Command Request signal switches from OFF to ON. 	Switched from ON back to OFF by the user (PLC) when the Result Notification signal from the FH turns ON.*1
Error Clear	Error Clear	Turn ON this signal to clear the Error Status signal from the Vision Sensor.	Turn ON the signal (from the PLC) when the Error Status signal turns OFF.	Turn OFF the signal (from the PLC) when the Error Status signal turns OFF.
Flow Command Request	Flow Command Request	Turn ON this signal to execute a command during execution of the fieldbus flow control.	Turn ON this signal (from the PLC) to request execution of a command that was input during execution of the fieldbus flow control.	Switches from ON back to OFF when the Flow Command Completion signal turns ON.
Trigger	Measurement Trigger	Turn ON this signal to execute measurements.	Turn ON this signal (from the PLC) to execute measurement after checking that the Trigger Ready signal is ON.	The PLC switches this signal from ON back to OFF when it detects Trigger Ack signal ON from the FH.

*1: A timeout error will occur if the Result Set Request signals does not turn OFF within the timeout time that is set in the EtherCAT settings after the Result Notification signal turns ON. However, data will not be corrupted even if a timeout error occurs for EtherCAT. Clear the timeout error and turn ON the Result Set Request signal to output the data from when the timeout occurred.

*2: A timeout error will occur if you do not turn ON the Result Set Request from the Sensor controller (master) within 10 seconds of when the Trigger signal, or the Command Request signal are turned ON and the measurement processing is initiated.

Output Signals

Signal	Signal Name	Function	ON/OFF timing	
			OFF to ON	ON to OFF
BUSY	Busy	<p>This signal tells when commands and other external inputs cannot be acknowledged. Make sure this signal is OFF before you request a command.</p> <p>*1: During continuous measurement, the BUSY signal remains ON. The FH accepts the Command Request signal only after receiving the End Continuous Measurement command.</p> <p>Note:</p> <ul style="list-style-type: none"> The execution of commands or other processing received through any other protocol cannot be detected. (Example: This signal remains OFF during measurements for a parallel communications Trigger signal.) If you use more than one protocol and need to detect command execution, use the parallel communications BUSY signal. ON of this signal does not indicate that the command is being executed. To check whether the command is being executed, check the status of the Command Completion signal. 	The Vision Sensor turns ON this signal when it receives a command from the user (PLC). (The signal turns ON after the Command Request signal turns ON.)	The signal turns OFF when command execution is completed.
Command Completion	Command Execution Completion	The Vision Sensor uses this signal to tell the user (PLC) that command execution has been completed.	The signal turns ON when the Vision Sensor completes execution of a received command.	Turns OFF when the user (PLC) switches the Command Request signal from ON to OFF.

Signal	Signal Name	Function	ON/OFF timing	
			OFF to ON	ON to OFF
Result Notification	Data Output Completion	<p>This signal tells the timing to load the output data to the User (PLC). This signal is ON: means that the data is output from Sensor Controller. Read the data (from the PLC) when this signal turns ON.</p>	<ul style="list-style-type: none"> • No Handshaking The signal turns ON after the Vision Sensor executes the Output Unit (Fieldbus Data Output Unit) in the measurement flow and preparations for data output have been completed. • Handshaking During execution*2 of the Profibus Data Output unit in the measurement flow by the FH, the signal turns ON when the data is ready to be output and the Result Set Request signal is ON. <p>*2: This occurs when the Output Unit is executed as the measurement flow is executed in order from the top. It does not occur when execution of a measurement is completed.</p>	<ul style="list-style-type: none"> • No Handshaking: The signal turns OFF after the output time that is set in the EtherCAT settings has elapsed. • Handshaking: This signal turns OFF when the user (PLC) switches the Result Set Request signal from ON to OFF.
Error Status	Error Signal	<p>The FH Sensor Controller provides notification with this signal when it detects the following errors. Refer to: ► <i>Error Messages and Troubleshooting</i> in the <i>Vision System FH/FZ5 Series User's Manual</i> (Cat. No. Z365).</p>	<p>This signal turns ON when the FH Sensor Controller detects an error.</p>	<p>This signal turns OFF when the error is eliminated and the user (PLC) performs another measurement or clears the error (i.e., turns ON the Error Clear signal).</p>
Run Mode	Run Signal	<p>This signal tells when the Sensor Controller is in Run Mode.</p>	<p>This is a notification signal indicating the FH Sensor Controller is in [RUN signal output] (In a measurement capable state with [RUN LED] checked in the Layout settings for the currently displayed line).</p>	<p>The signal is OFF when the FH Sensor Controller cannot execute measurements and the [RUN signal output] is not selected in the Layout Setup on the Layout Window.</p>
Total Judgment	Overall Judgement	<p>This signal gives the results of the overall judgement.</p>	<p>The signal turns ON when the overall judgement is NG.</p>	<p>The signal turns OFF when the overall judgement is OK.</p>
Trigger ACK	Trigger Acknowledge	<p>The FH Sensor Controller uses this signal to acknowledge reception of a Trigger signal.</p>	<p>The signal turns ON when the Vision Sensor receives a Trigger signal.</p>	<p>The signal turns OFF when the user (PLC) turns OFF the Trigger signal.</p>
Command Ready	Command Execution Ready	<p>This signal tells when control command can be executed.</p>	<p>The signal turns ON when control command execution is possible.</p>	<p>The signal turns OFF when control command execution is not possible.</p>

Signal	Signal Name	Function	ON/OFF timing	
			OFF to ON	ON to OFF
Trigger Ready	Trigger Input ready	<p>This signal tells when the Cameras that are assigned to the Trigger signals can execute measurements.</p> <p>*1: If you use a Camera with Lighting Controller, the time required for the Trigger Ready signal to turn OFF may increase in comparison with not using a Camera with a Lighting Controller. For details, refer to ▶ <i>Camera Image Input FH or Camera Image Input HDR in the Vision System FH/FZ5 Series Processing Items Reference Manual</i> (Cat. No. Z341).</p>	This signal is ON when the Cameras that are assigned to the Trigger signals can execute measurements (i.e., when a Trigger signal can be input).	This signal is OFF when even one of the Cameras that are assigned to Trigger signals cannot execute measurements (i.e., when a Trigger signal cannot be input).
Shutter Output	Shutter Trigger Output	<p>This signal tells when exposure of the sensing elements has been completed.</p> <ul style="list-style-type: none"> • If more than one Camera is connected, the signal will remain ON for the Camera with the longest exposure time. • You cannot use the Shutter Output Signal when the image mode is set for a through image. If you have registered more than one Camera Image Input processing unit in the measurement flow, the SHTOUT signal will be turned ON for each Camera Image Input processing unit individually. Therefore, use Camera Switching processing items instead of Camera Image Input processing items in the middle of the measurement flow. 	The signal is ON when the sensing elements have completed exposure.	The signal operates according to the output signal settings. After the completion of exposure, the signal turns ON after the time that is set for the Shutter Output Signal elapses and then turns OFF after the time that is set for the Shutter Output Pulse Width elapses. Refer to ▶ <i>Setting the Output Signal Specifications</i> (p.305) for information on the Shutter Output Signal settings.
Flow Command Completion	Flow Command Execution Completion	This signal tells when execution of a command that was executed during execution of the fieldbus flow control has been completed.	Turned ON after echo back, response code and response data have been set for an executed command code when the executed command has completed when executing Fieldbus flow control.	Switched from ON to OFF when the Flow Command Request signal switches from ON to OFF when executing Fieldbus flow control.
Flow Command Busy	Flow Command Executing	This signal tells when a command that was input during execution of the fieldbus flow control is being executed.	This signal is ON when a command that was input during execution of the fieldbus flow control is being executed.	Switched from ON to OFF when execution of an entered command completes when executing Fieldbus flow control.

Signal	Signal Name	Function	ON/OFF timing	
			OFF to ON	ON to OFF
Flow Command Wait	Flow Command Wait	This signal tells when input of a command can be acknowledged during execution of the fieldbus flow control.	This signal is ON when a command can be input during execution of the fieldbus flow control.	Switched from ON to OFF when the Flow Command Request signal switches from ON to OFF when executing Fieldbus flow control.

Measurement Results That You Can Output with Fieldbus Data Output

You can use the processing items that are related to outputting results to output the following data.

You can also access measured values from the Calculation or other processing units.

Measured items	Text string	Description
Judgement	JG	Judgement result
DINT data 0 to 63	DI00 to DI63	<ul style="list-style-type: none"> Results of expressions that are set for output data 0 to 63 in DINT (4-byte) format Outputs the value in the below by 1000 times as an integer type. -2147483.648 to 2147483.647
LREAL data 0 to 31	DL00 to DL31	<ul style="list-style-type: none"> Results of expressions that are set for output data 0 to 31 in LREAL (8-byte) format Outputs the values in the follows range as a Floating point. -99999999.9999 to 99999999.9999

External Reference Table for Fieldbus Data Output

By specifying a number, the following data can be referenced from control commands or processing items that have a set/get unit data function.

Number	Data name	Set/Get	Data range
0	Judgement	Get only	0: No judgement (unmeasured) 1: Judgement result OK -1: Judgement result NG
1000+10*N(N=0...63)	DINT data 0 to data 63	Get only	-99999999.9999 to 99999999.9999 ^{*1}
2000+10*N(N=0...31)	LREAL data 0 to data 31	Get only	-99999999.9999 to 99999999.9999 ^{*1}

*1: Since the response data area is DINT type, the data is acquired as an integer type and a thousand value of the following range
-2147483.648 to 2147483.647

Command List

This section describes the commands that you can use with EtherCAT.

Note

Use device variables assigned to the I/O port of the command area to specify command codes and command parameters of commands used in EtherCAT.

To specify a command code or command parameter for a device variable, refer to the following:

- ▶ Details of Commands Used in EtherCAT Communication (p.354)

Execution Commands

Command code for Command Area (hex)	Command name	Function	Reference
0010 1010	Single Measurement	Performs 1 measurement.	Reference: ▶ (p.361)
0010 1020	Start Continuous Measurements	Executes continuous measurements.	Reference: ▶ (p.361)
0010 1030	End Continuous Measurements	Ends continuous measurements.	Reference: ▶ (p.362)
0010 1040	Execute Unit Test	Executes a test measurement for the specified Unit.	Reference: ▶ (p.362)
0010 2010	Clear Measurement Values	Clears all measurement result values.	Reference: ▶ (p.363)
0010 2020	Clear Data Output Buffer	Clear the data output buffer.	Reference: ▶ (p.363)
0010 3010	Save Data in Sensor	Saves the current system data and scene groups in the Sensor.	Reference: ▶ (p.364)
0010 4010	Re-register Model	Registers the model again.	Reference: ▶ (p.365)
0010 5010	Scroll	Shifts the image display position by the specified amount.	Reference: ▶ (p.366)
0010 5020	Zoom	Zooms the image display in or out by the specified factor.	Reference: ▶ (p.366)
0010 5030	Fit	Returns the display position and display magnification to their default values.	Reference: ▶ (p.367)
0010 7010	Copy Scene Data	Copies the scene data.	Reference: ▶ (p.368)
0010 7020	Delete Scene Data	Deletes the scene data.	Reference: ▶ (p.368)
0010 7030	Store Scene Data	Stores the scene data.	Reference: ▶ (p.369)
0010 8020	Load Registered Image	Loads the specified registered image as the measurement image.	Reference: ▶ (p.370)
0010 9010	Echo	Returns an entered text string without changing it.	Reference: ▶ (p.371)
0010 B010	Return to Start of Flow	Branches to the start of the measurement flow (processing unit 0).	Reference: ▶ (p.373)
0010 F010	Restart	Restarts the Sensor Controller.	Reference: ▶ (p.374)

Commands to Get Status

Command code for Command Area (hex)	Command name	Function	Reference
0020 1000	Get Scene Number	Acquires the current scene number.	Reference: ► (p.374)
0020 2000	Get Scene Group Number	Gets the scene group number.	Reference: ► (p.375)
0020 4000	Get Layout Number	Gets the number of the layout that is currently displayed.	Reference: ► (p.376)
0020 5010	Get Display Image Unit Number	Gets the number of the Unit that is currently displayed in the specified image display window.	Reference: ► (p.376)
0020 5020	Get Display Subimage Number	Gets the subimage number for the specified image display window.	Reference: ► (p.377)
0020 5030	Get Image Display Status	Gets the image mode for the specified image display window.	Reference: ► (p.378)
0020 7010	Get Communications Input Status	Gets the input status (enabled/disabled) for the Communications Modules.	Reference: ► (p.378)
0020 7020	Get Communications Output Status	Gets the output status (enabled/disabled) to external devices.	Reference: ► (p.379)
0020 8010	Get Parallel Terminal Status	Gets the ON/OFF status of the specified parallel I/O terminal.	Reference: ► (p.380)
0020 8020	Get All Parallel Terminal Statuses	Gets the ON/OFF status of all parallel terminals except for DI terminals	Reference: ► (p.381)
0020 8030	Get All Parallel DI Terminal Statuses	Gets the ON/OFF status of all parallel DI terminals	Reference: ► (p.385)
0020 A000	Get Operation Log State	Gets the current state of the operation log.	Reference: ► (p.388)

Commands to Set Status

Command code for Command Area (hex)	Command name	Function	Reference
0030 1000	Select Scene	Changes to the specified scene number.	Reference: ► (p.390)
0030 2000	Set Scene Group	Changes to the scene group with the specified number.	Reference: ► (p.390)
0030 4000	Set Layout Number	Sets the layout number and changes the image.	Reference: ► (p.391)
0030 5010	Set Display Image Unit Number	Sets the number of the Unit to display in the specified image display window.	Reference: ► (p.392)
0030 5020	Set Display Subimage Number	Sets the number of the subimage to display in the specified image display window.	Reference: ► (p.392)
0030 5030	Set Image Display Status	Sets the image mode for the specified image display window.	Reference: ► (p.393)
0030 7010	Set Communications Input Status	Enables/disables inputs to the Communications Modules.	Reference: ► (p.394)

Command code for Command Area (hex)	Command name	Function	Reference
0030 7020	Set Communications Output Status	Enables/disables outputs to external devices.	Reference: ▶ (p.394)
0030 8010	Set Parallel Terminal Status	Sets the ON/OFF status of the specified parallel I/O terminal.	Reference: ▶ (p.395)
0030 8020	Set All Parallel Terminal Statuses	Sets the ON/OFF status of all parallel terminals, except for DO terminals	Reference: ▶ (p.395)
0030 8030	Set All Parallel DO Terminal Statuses	Sets the ON/OFF status of all parallel DO terminals	Reference: ▶ (p.397)
0030 A000	Set Operation Log State	Sets the state of the operation log.	Reference: ▶ (p.404)

Commands to Read Data

Command code for Command Area (hex)	Command name	Function	Reference
0040 1000	Get Unit Data	Gets the unit data.	Reference: ▶ (p.405)
0040 4050	Get Data Logging Conditions	Gets the conditions that are set for data logging.	Reference: ▶ (p.410)
0040 4060	Get Parallel Terminal Offset	Gets the parallel DI terminal offset data that is set.	Reference: ▶ (p.411)

Commands to Write Data

Command code for Command Area (hex)	Command name	Function	Reference
0050 1000	Set Unit Data	Sets the unit data.	Reference: ▶ (p.412)
0050 4050	Set Data Logging Conditions	Sets the data logging conditions.	Reference: ▶ (p.417)
0050 4060	Set Parallel Terminal Offset	Sets the parallel DI terminal offset data.	Reference: ▶ (p.417)

Measurement Trigger Input

The ON/OFF timing of signals related to input of the measurement trigger is indicated in the timing chart below.

Measurement Trigger Input Timing Chart

The Trigger signal is used to input a measurement trigger. One measurement is executed each time the Trigger signal turns ON.

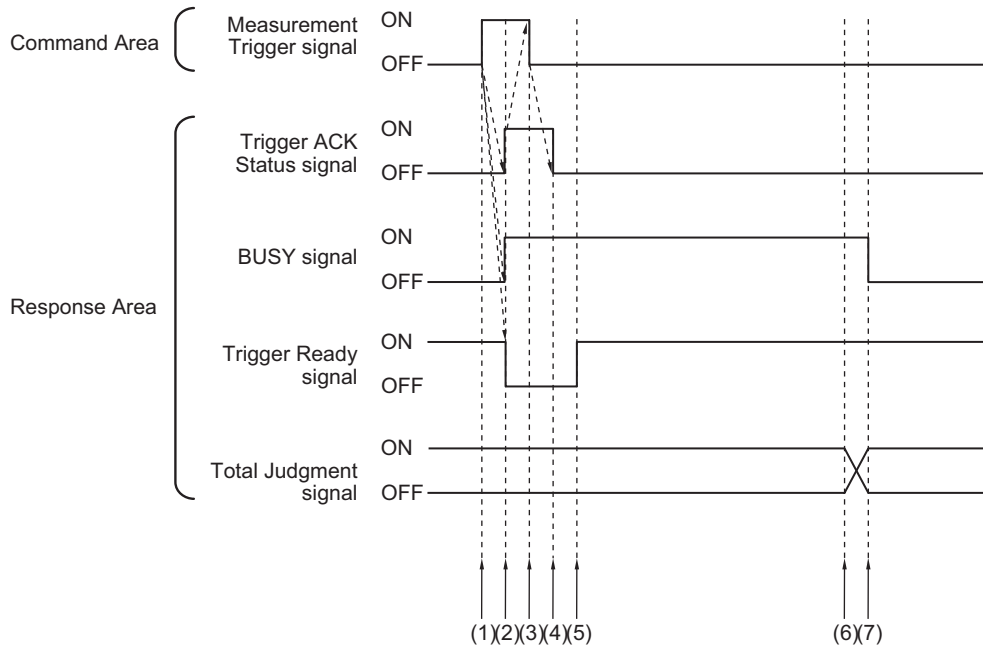

- (1) After checking the Trigger Ready signal is ON, the Controller (master) turns the Trigger signal ON.
- (2) The Sensor Controller (slave) will change the state of the following signals.
 - The BUSY signal turns ON when the measurement starts.
 - Trigger ACK signal turns ON.
 - The Trigger Ready signal turns OFF.
- (3) The controller (master) turns OFF the Trigger signal.
- (4) The Sensor Controller (slave) turns OFF the Trigger ACK signal.
- (5) The Sensor Controller (slave) turns the Trigger Ready signal ON when image input has finished and the Sensor Controller (slave) is ready for measurement trigger input.
- (6) When measurement processing has finished, the Sensor Controller (slave) turns the Total Judgment signal ON.
- (7) When measurement processing has finished, the Sensor Controller (slave) turns the Busy signal OFF.

Command Response Processing

The ON/OFF timing of related signals from command input in control command response processing is indicated in the timing chart below.

Timing Chart for Command Execution

The Command Request signal is used as the trigger for input/execution of commands from the Controller (master) for operations such as measurement execution.

After command execution, switch the Command Request signal back to OFF using the Command Completion signal = ON as the trigger.

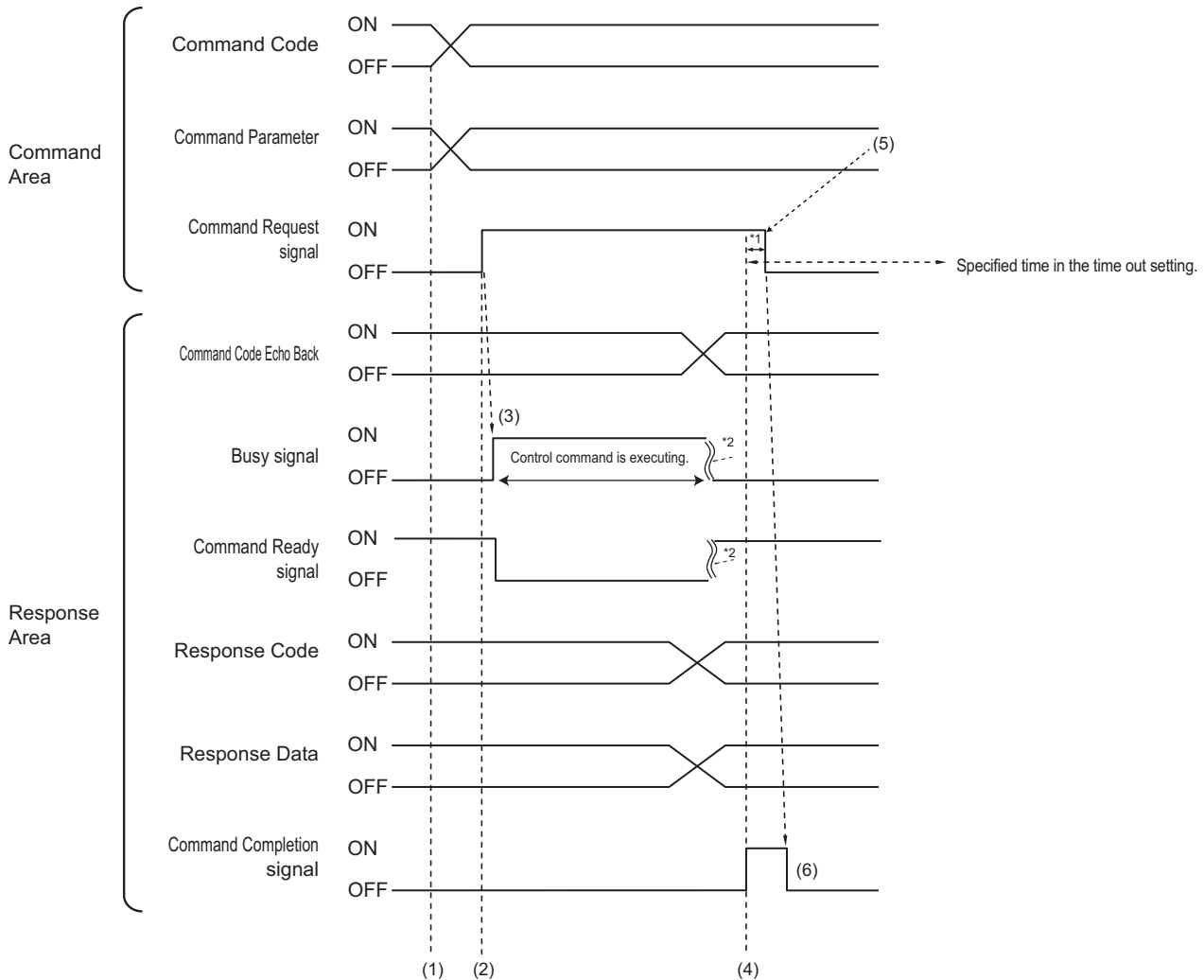

*1: A timeout error will occur if the Command Request signals does not turn OFF within 10 seconds. Then Command Completion signal and Busy signal will be forced to turn OFF.

*2: Busy signal are automatically switched from ON to OFF when command execution is completed.

- (1) The Controller (master) sets the command code and command parameters.
- (2) After checking that the Command Ready signal is ON and the Command Completion signal is OFF, the Controller (master) turns the Command Request signal ON.
- (3) The Sensor Controller (slave) turns ON the Busy signal.
- (4) The Sensor Controller (slave) sets command echo back, the response code and response data, then turns the Command Completion signal ON.
- (5) The Controller (master) turns OFF the Command Request signal.
- (6) The Controller Sensor (slave) turns OFF the Command Completion signal.

Continuous Measurement Command without Handshaking

Continuous execution is used to repeatedly execute measurements by starting the next measurement operation (image input and measurement processing) as soon as one measurement operation (image input and measurement processing) is completed.

Continuous measurements are started when the Start Continuous Measurements command is executed and ended when the End Continuous Measurements command is executed.

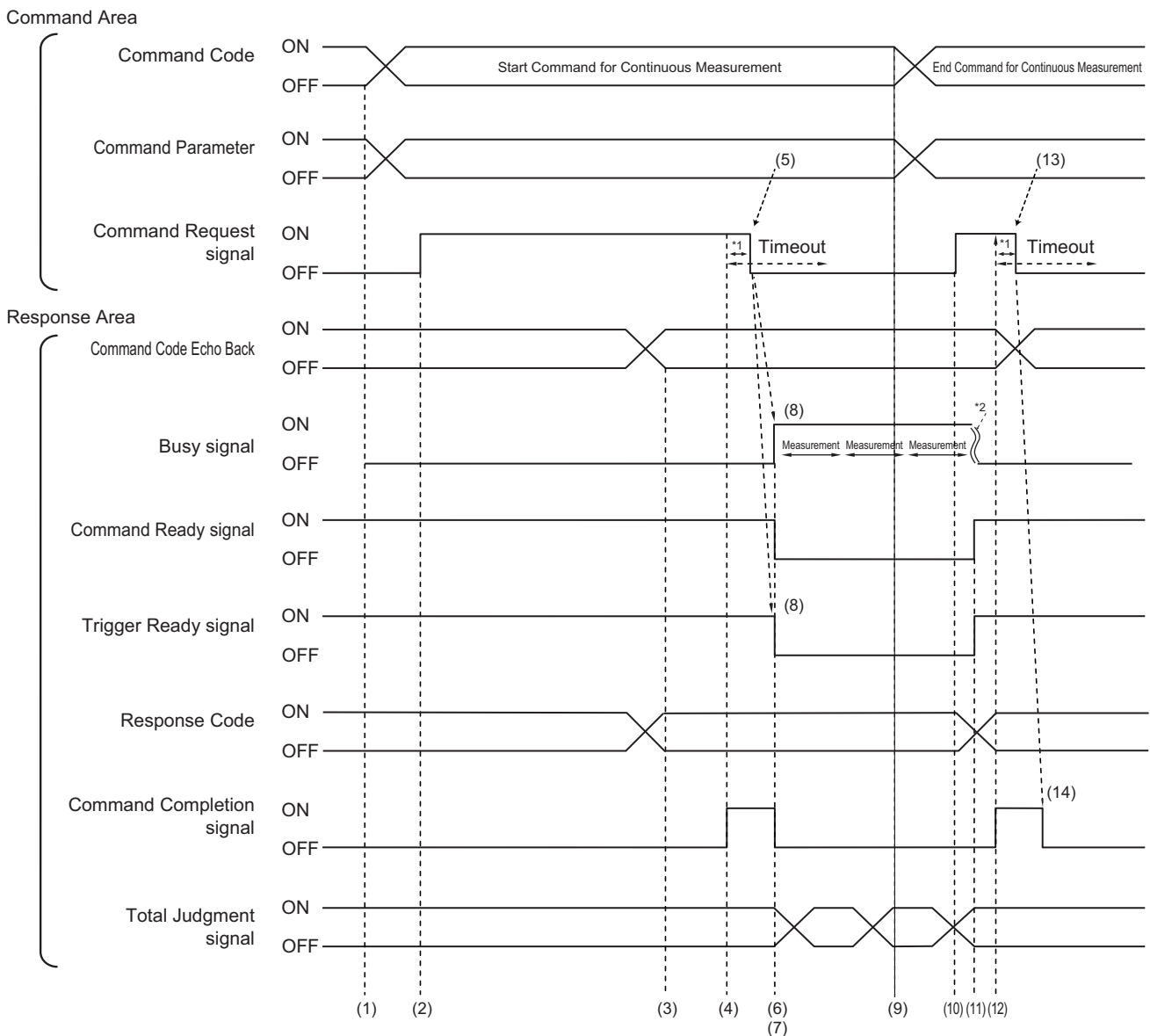

*1: A timeout error will occur if you turn off the Command Request signal within 10 seconds after the Command Completion signal is turned ON. Command Completion signal and Busy signal will be forcefully turned OFF.

*2: Busy signal are automatically switched from ON to OFF when command execution is completed.

Operation to Start Continuous Measurements

- (1) The Command code and command parameters are set by the Controller (master).
- (2) After checking that the Command Ready signal is ON and the Command Completion signal is OFF, the Controller (master) turns ON the Command Request signal.
- (3) The Sensor Controller (slave) echoes back the command code and sets the response code.
- (4) The Sensor Controller (slave) turns ON the Command Completion signal.
- (5) The controller (master) turns OFF the Command Request signal.
- (6) The Sensor Controller (slave) turns OFF the Command Completion signal.
- (7) The Sensor Controller (slave) starts continuous measurement.
- (8) The Sensor Controller (slave) turns the Busy signal ON and the Trigger Ready signal OFF.

Operation to End Continuous Measurements

- (9) The Controller (master) sets the command code for the End Continuous Measurements command when continuous measurement is being executed by the continuous measurement command.
- (10) The Controller (master) turns ON the Command Request signal.

Note

Continuous measurements are not ended in the middle of a measurement. When the End Continuous Measurements command is executed, continuous measurements are ended after the measurement that is currently being executed is completed.

• Ending Continuous Measurements

- (11) The Sensor Controller (slave) stops continuous measurement and turns off the Busy signal.
- (12) The Sensor Controller (slave) sets command code echo back and the response code, and turns the Command Completion signal ON.
- (13) The controller (master) turns OFF the Command Request signal.
- (14) The Sensor Controller (slave) turns OFF the Command Completion signal.

IMPORTANT

-
- The measurements during continuous measurements are given priority. Therefore, display of the measurement results (total judgment, images, judgment for each processing unit in the flow display, and detailed results) may sometimes not be updated.
 - When continuous measurements are ended, the measurement results from the last measurement will be displayed.
-

Data Output

The ON/OFF timing of signals related to data output after completion of measurement is indicated in the timing chart below.

No Handshaking

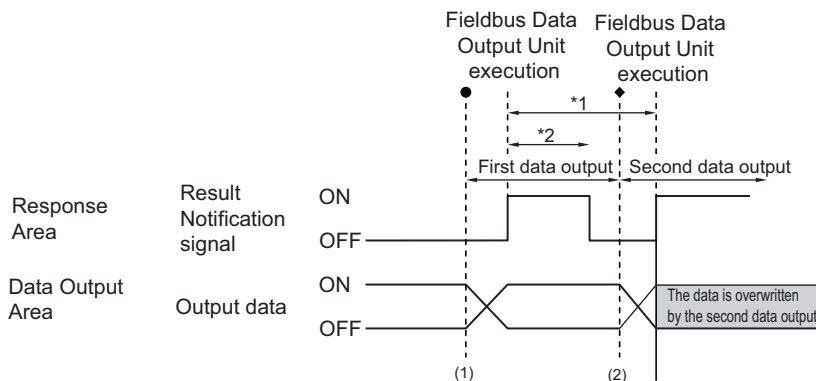

*1, *2: Data is output at the set output period*¹ and for the set output time.*² After data is output, the Result Notification signal is turned ON and the data is held for the data output time.

- (1) The Sensor Controller (slave) outputs data when the Fieldbus Data Output Unit starts execution.
- (2) Data is output every time the Fieldbus Data Output Unit or another Fieldbus Data Output Unit is executed. The previously output data is overwritten.

IMPORTANT

Set the output period in the communications settings to a time that is longer than the output time.

Using Handshaking

The Result Notification signal is switched from OFF to ON when the Controller (master) switches the Result Set Request signal from OFF to ON. At this point, the Sensor Controller (master) outputs the data(*1) that is ready to be output.

Switch the Result Set Request signal from ON back to OFF after the Controller (master) has checked that the Result Notification signal is ON and has read the data.

When there are data to be sent from multiple Fieldbus Data Output units, turn ON the Result Set Request signal again to output the next output data when the Sensor Controller (slave) turns the Result Notification signal from ON to OFF.

*1: This is the data that is prepared for output when the Output Unit is executed in the measurement flow.

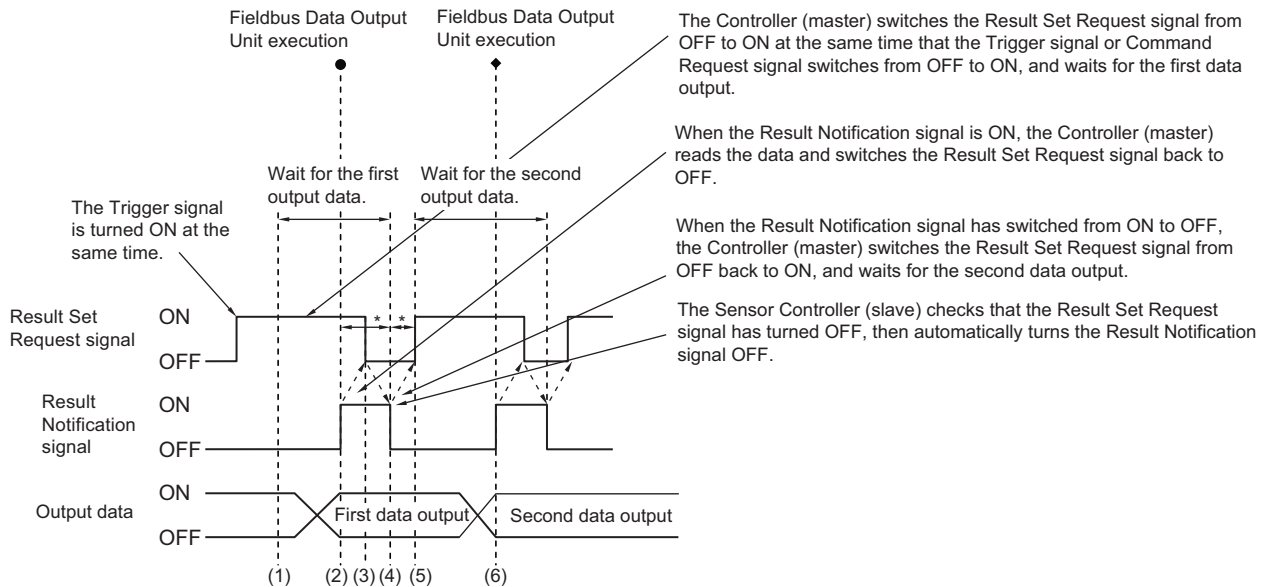

*: A timeout error will occur if any of the following states continues for longer than the timeout time that is set in the EtherCAT settings.

- If the Result Set Request signal is not turned ON after a certain time elapses from when the Output Unit is executed. (Turn ON the Result Set Request at the same time as the measurement trigger input or the command input.)
- If the Result Set Request signal is not turned OFF after a certain time elapses from when the Result Notification signal turned ON.

- (1) The Controller (master) turns ON the Result Set Request signal.
- (2) When the Fieldbus Data Output Unit in the measurement flow is executed, the Sensor Controller (slave) writes the data then turns the Result Notification signal ON.
- (3) After reading the data, the Controller (master) turns the Result Set Request signal OFF.
- (4) The Sensor Controller (slave) turns OFF the Result Notification signal.
- (5) If there are multiple Field Data Output Units in the measurement flow, the Controller (master) turns the Result Set Request signal ON, then waits for execution of the next Fieldbus Data Output Unit to be processed.
- (6) When the next Fieldbus Data Output Unit is executed, the Sensor Controller (slave) writes the data, then turns the Result Notification signal ON.
Repeat steps 3 to 6.

Time Charts

The ON/OFF timing of signals related to the sequence of operation from control command input until data output after completion of measurement is indicated in the timing chart below.

Example 1: Inputting a Measurement Trigger after Changing a Scene without Handshaking

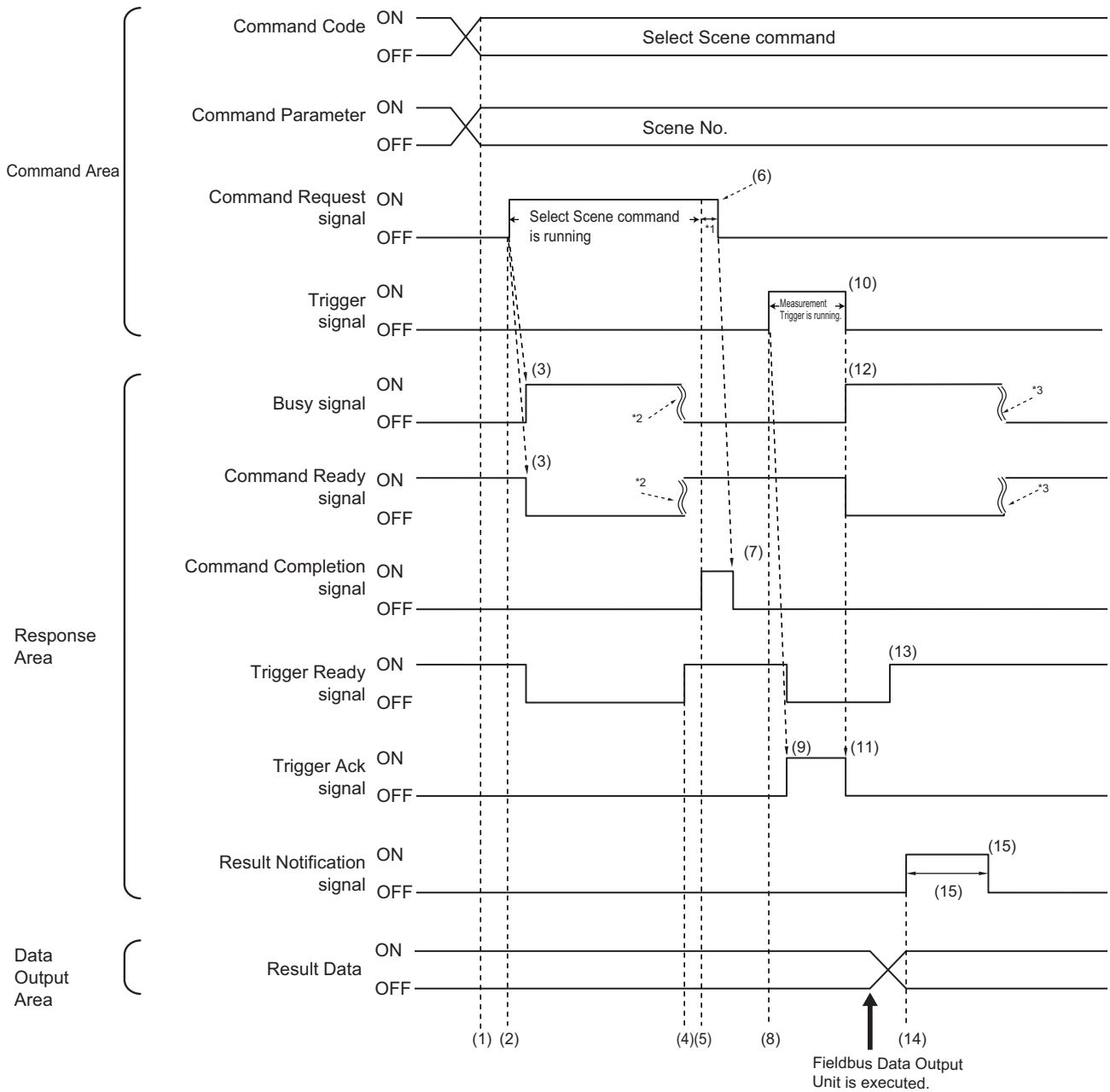

*1: A timeout error will occur if you turn off the Command Request signal from Sensor Controller (master) within 10 seconds. Then Command Completion signal and Busy (BUSY) signal will be forced to turn off.

*2: Busy (BUSY) signal is automatically switched ON from OFF when the command execution is completed.

*3: Busy (BUSY) signal is automatically switched ON from OFF when the measurement is completed.

- (1) The Controller (master) sets the command code and command parameters for the scene switching command.
- (2) After checking that the Command Ready signal is ON and the Command Completion signal is OFF, the Controller (master) turns ON the Command Request signal.
- (3) The Sensor Controller (slave) turns the Busy signal ON, turns the Command Ready signal OFF and changes the scene.
- (4) When the scene change has finished, the Sensor Controller (slave) turns the Busy signal OFF and turns the Command Ready signal ON.
- (5) The Sensor Controller (slave) turns ON the Command Completion signal.

- (6) The Controller (master) turns OFF the Command Request signal.
- (7) The Sensor Controller (slave) turns OFF the Command Completion signal.
- (8) The Controller (master) turns ON the Trigger signal.

Note

Before inputting a measurement trigger after changing the scene, first check that the Command Completion signal that was turned ON by execution of the scene change command has turned OFF, and that the Trigger Ready signal is ON.

- (9) The Sensor Controller (slave) turns ON the Trigger ACK signal, and turns OFF the Trigger Ready signal.
- (10) The Controller (master) turns the Trigger signal OFF.
- (11) The sensor controller (slave) turns OFF the Trigger ACK signal.
- (12) The Sensor Controller (slave) turns Busy signal to ON, then executes measurement processing.
- (13) When image input processing has finished and trigger input is enabled, the Sensor Controller (slave) turns the Trigger Ready signal ON.
- (14) When the Fieldbus Data Output processing unit within the measurement flow is executed, the Sensor Controller (slave) turns ON the Result Notification signal after writing the data.
- (15) When the time set for [Output time] in the EtherCAT settings has elapsed, the Sensor Controller (slave) turns the Result Notification signal OFF.

Example 2: Outputting Data with More Than One Output Unit without Handshaking

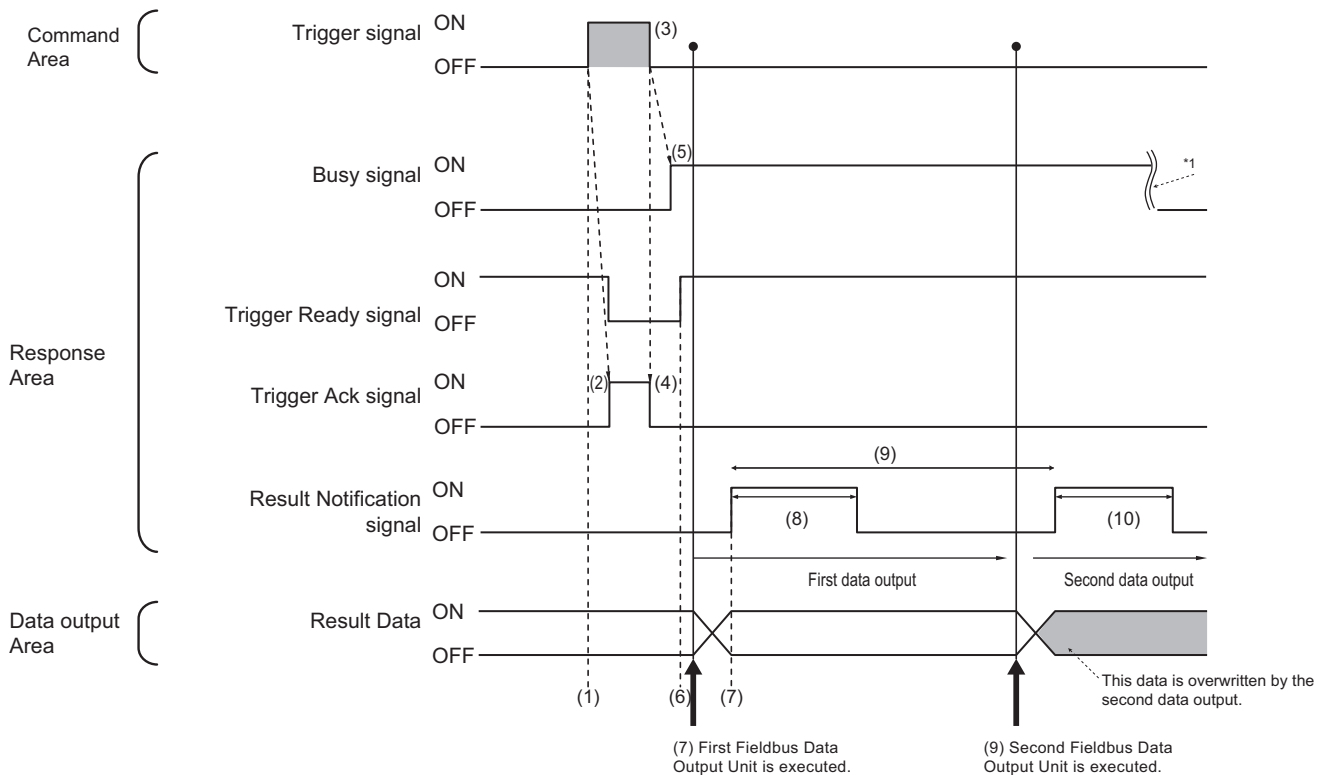

*1: Busy (BUSY) signal is automatically switched ON from OFF when the command execution is completed.

- (1) After checking that the Trigger Ready signal is ON and the Command Completion signal is OFF, the Controller (master) turns ON the Trigger signal.
- (2) The Sensor Controller (slave) turns ON the Trigger Ack signal, and turns OFF the Trigger Ready signal.
- (3) The controller (master) turns OFF the Trigger signal.
- (4) The Sensor Controller (slave) turns OFF the Trigger ACK signal.
- (5) The Sensor Controller (slave) turns the Busy signal ON and executes measurement processing.
- (6) The Sensor Controller (slave) turns the Trigger Ready signal to ON when the image input processing is completed and trigger is ready to input.
- (7) When the first Fieldbus Data Output Unit in the measurement flow is executed, the Sensor Controller (slave) writes the data, then turns the Result Notification signal ON.
- (8) When the time set for [Output time] in the EtherCAT settings has elapsed, the Sensor Controller (slave) turns the Result Notification signal OFF.
- (9) When the second Fieldbus Data Output Unit in the measurement flow is executed after the output cycle of the first Fieldbus Data Output Unit has elapsed, the Sensor Controller (slave) turns the Result Notification signal ON.
- (10) When the time set for [Output time] in the EtherCAT settings has elapsed, the Sensor Controller (slave) turns the Result Notification signal OFF.

Note**Saving All of the Measurement Results**

If you output data from more than one Data Output Unit or for repeatedly measured output data (e.g., for continuous measurements), the same Data Output Area will be overwritten.

To save all of the output data, adjust the output period and output time that are set in the EtherCAT settings so that all of the output data is output and either receive all of the output data by using the Result Notification signal or use handshaking control.

Handshaking lets you control data output by using the Result Notification signal turning ON as a trigger for the data output timing and turning ON the Result Set Request to read the output data.

Each time that data is output (from the second output on), read the output data and move it to a different part of I/O memory in the PLC.

Refer to ► Data Output Control with Handshaking (p.32) for more information on handshaking.

You can compare the received number of output data and the number of measurements for continuous measurements to check if all of the measurement results have been received.

Use the following method to check the number of measurements that was actually executed.

- Application Example

Set a calculation to count the number of measurements that are executed in the measurement flow.

If you set something like [DO+1], each time a measurement is executed (each time the measurement flow is executed), 1 will be added to DO, so the present value of DO will give you the actual number of measurements.

EtherCAT Troubleshooting

Cannot Communicate with Sensor Controller

Problem	Cause	Action
There is absolutely no data I/O.	The node address is set incorrectly.	Check the node address setting switches to see if they are set correctly.
	The devices are not connected correctly.	Make sure that the EtherCAT connectors (input and output) are connected correctly.
	The <i>Output</i> Option is not selected in the Adjustment Window.	Select the <i>Output</i> Option in the Adjustment Window.
	Incorrect Communication is set.	Verify that Communication is set to EtherCAT.
Slave Initialization Error (84230000 hex) will occur and EtherCAT communications will be lost.	PDO Mapping information is different between the FH Sensor Controller and NJ/NX series controller.	Confirm that the following parameters are the same values between the FH Sensor Controller and NJ/NX series controller. <ul style="list-style-type: none"> • the Data output byte size • the use of the User area • the Number of controlled lines
Slave Application Error (84280000 hex) will occur and EtherCAT communications will be lost.	The Communication cycle (PDO Communication cycle time) is set lower than the minimum value.	Do not set the communication cycle (PDO communication cycle time) for EtherCAT communication to a value lower than the applicable minimum time given in the following table. Refer to ► Minimum PDO Communications Cycle Time (p.58)

A Timeout Error Occurred

Problem	Cause	Action
A handshaking timeout error occurred.	The Result Set Request signal is being turned ON and OFF too slowly. The following patterns are possible. <ul style="list-style-type: none"> • The Result Set Request signal does not turn ON after a measurement is completed. • The Result Set Request signal does not turn OFF after the Result Notification signal turns ON. • The Result Set Request signal does not turn ON after the Result Notification signal turns OFF. 	After the measurement command is executed, turn the Result Set Request signal ON and OFF within the timeout time that is set in the EtherCAT communications settings. Or, increase the length of the timeout time that is set in the EtherCAT settings.

Settings are not kept

Problem	Cause	Action
Settings, such as Fieldbus Data Output Calculations, or Comments, are not being kept.	Changed the Communication settings after setting of Fieldbus Data Output.	Specify the Fieldbus Data Output settings after settings of Communication.

Note

Errors that occur in the EtherCAT system, including sensor errors, are displayed as a Sysmac error status in Sysmac Studio (Standard Edition).

Refer to ► Sysmac Error Status (p.96).

Sysmac Error Status

The Sysmac Studio Standard Version displays errors that occur in the EtherCAT system (including Sensor errors) as Sysmac error status.

Sysmac Error Status Event Code Table

This section describes Sysmac error status event codes that are related to the sensor.

Refer to the ► *NJ-series Troubleshooting Manual* (Cat. No. W503) for details on event codes.

Levels: Maj: Major fault level, Prt: Partial fault level, Min: Minor fault level, Obs: Observation, Info: Information

Event code	Event name	Meaning	Assumed cause	Level ^{*1}					Reference
				Maj	Prt	Min	Obs	Info	
08210000 hex	Fan/Power Supply Error	An error occurred in the fan or power supply.	<ul style="list-style-type: none"> A foreign object is interfering with fan operation. A suitable power supply voltage is not being used, resulting in an overvoltage or undervoltage. 			√			Reference: ► (p.101)
08220000 hex	Camera Overcurrent Detected	An overcurrent flowed to the Camera.	<ul style="list-style-type: none"> There is a short circuit inside the Camera cable or in a circuit inside the Controller. 			√			Reference: ► (p.101)
08230000 hex	Parallel I/O Overcurrent Detected	An overcurrent occurred in the parallel I/O interface.	<ul style="list-style-type: none"> A parallel I/O interface line is short-circuited. 			√			Reference: ► (p.102)
182D0000 hex	Setting Data Load Error	Loading the scene group data failed.	<ul style="list-style-type: none"> The data is corrupted because the power supply was turned OFF while saving the previous scene data. As the result of changing the operation mode, the required amount of memory increased, resulting in insufficient memory. 			√			Reference: ► (p.102)
385A0000 hex	Change in Connected Camera	The Camera that is connected is different from when data was last saved.	<ul style="list-style-type: none"> The Camera connection information in the scene data does not agree with the connection information for the Camera connected to the Controller. 			√			Reference: ► (p.103)

Event code	Event name	Meaning	Assumed cause	Level ^{*1}					Reference
				Maj	Prt	Min	Obs	Info	
38590000 hex	Camera Connection Error	The Camera connection is wrong.	<ul style="list-style-type: none"> A Camera is not connected to the Controller. The Camera cable is broken. The Camera Selection settings are not correct in the Camera Image Input and Camera Switching processing items. A Camera is not connected to the Camera port on the Controller according to the Camera Selection settings in the Camera Image Input and Camera Switching processing items. 			√			Reference: ▶ (p.104)
48020000 hex	System Error	An error occurred in the system.	<ul style="list-style-type: none"> A serious error occurred in the system in the Controller. 			√			Reference: ▶ (p.104)
58210000 hex	Output Control Timeout for Parallel I/O, PLC Link, or EtherNet/IP	A timeout occurred in data output handshaking control for measurement results.	<ul style="list-style-type: none"> The data output handshaking controls in the program (i.e., the ON/OFF timing of the Result Set Request signal) are not correct. The output control timeout time is too short in comparison with the program processing time. The parallel I/O Result Set Request or Result Notification signal is not wired correctly. 			√			Reference: ▶ (p.105)
58220000 hex	Output Control Timeout for EtherCAT	A timeout occurred in data output handshaking control for measurement results.	<ul style="list-style-type: none"> The data output handshaking controls in the program (i.e., the ON/OFF timing of the Result Set Request signal) are not correct. The output control timeout time is too short in comparison with the program processing time. 			√			Reference: ▶ (p.106)
78190000 hex	Logging Disk Write Error	Writing data to the logging disk failed.	<ul style="list-style-type: none"> A logging disk is not inserted. The available space on the logging disk is not sufficient. There is no logging folder. Security restrictions are set on the logging disk. 			√			Reference: ▶ (p.106)

Event code	Event name	Meaning	Assumed cause	Level*1					Reference
				Maj	Prt	Min	Obs	Info	
781A0000 hex	Setting Data Transfer Error	An error occurred while transferring the scene data.	<ul style="list-style-type: none"> Scene data was edited when there was little available space on the RAM disk and the operation mode was Double Speed Multi-input. The data transfer button was clicked when there was little available space on the RAM disk and the operation mode was Non-stop Adjustment Mode. 			√			Reference: ▶ (p.107)
781B0000 hex	Output Buffer Error (EtherCAT)	The data output buffer for measurement data is full.	<ul style="list-style-type: none"> Data measurements are being performed on a period that is shorter than the time that is required for data output handshake controls in the program. 			√			Reference: ▶ (p.107)
88080000 hex	PLC Link Communications Error	A PLC Link cannot be established.	<ul style="list-style-type: none"> There is a mistake in the PLC or Vision Sensor communications settings. The Ethernet or RS-232C cable is damaged. 			√			Reference: ▶ (p.108)
385B0000 hex	Lighting connection error	The lighting connection configuration is wrong.	<ul style="list-style-type: none"> The power consumption of the lighting connected to the camera mounted lighting controller is wrong. The lighting mode of the lighting connected to the camera mounted lighting controller is wrong. External power supply is not connected to camera mounted lighting controller. 			√			Reference: ▶ (p.108)
58230000 hex	Invalid Scene group at startup	Invalid Startup Scene group setting.	<ul style="list-style-type: none"> The external storage set in the scene group save destination setting is not connected at startup. Scene group Save destination directory at startup does not exist. The scene group number at startup is set outside the scope of the scene group specified by the system. 			√			Reference: ▶ (p.109)
58240000 hex	Invalid Scene No. at startup	Invalid startup Scene No. setting.	<ul style="list-style-type: none"> The scene number at startup is set larger than the range of the scene specified by the system. 			√			Reference: ▶ (p.109)

*1: Major Fault Level

- These errors prevent control operations for the entire Controller. If a major fault level error is detected, user program execution is stopped immediately and the loads for all slaves (including remote I/O) are turned OFF. You cannot reset major fault level errors from the user program, the Sysmac Studio, or an NS-series PT. To recover from a major fault level error, remove the cause of the error, and either cycle the power supply to the Controller or reset the Controller from the Sysmac Studio.

- **Partial Fault Level**
These errors prevent control operations in a certain function module in the Controller. The NJ-series CPU Unit continues to execute the user program even after a partial fault level error occurs. After you remove the cause of the error, execute one of the following to return to normal status.
 - Reset the error from the user program, the Sysmac Studio, or an NS-series PT.
 - Cycle the power supply to the Controller.
 - Reset the Controller from the Sysmac Studio.
- **Minor Fault Level**
These errors prevent part of the control operations in a certain function module in the Controller. The troubleshooting for minor fault level errors is the same as the processing for partial fault level errors.
- **Observations**
These errors do not affect the control operations of the Controller. Observations serve as warnings to the user so that the error does not develop into an error at a higher level.
- **Information**
Events that are classified as information do not indicate errors.

Checking Sysmac Error Status

You can use the troubleshooting functions of the Sysmac Studio Standard Version to check the Sysmac error status. Refer to the ► *NJ-series Troubleshooting Manual* (Cat. No. W503) for information on troubleshooting functions.

- 1 Select [Troubleshooting] from the Tools Menu while online. You can also click the [Troubleshooting] button in the toolbar.**
The Troubleshooting Dialog Box is displayed.

- 2 Click the [Controller Errors] tab.**
A list of the current Sysmac error status and corresponding event codes will be displayed.

Clearing the Sysmac Error Status

- 1 Remove the cause of the error and then click the [Reset All] button on the [Controller Errors] tab page of the [Troubleshooting] pane.**

Note

Even if you reset the Sysmac error status, the error log will remain in the logs on the [Controller Event Log] tab.

Error Details

This section provides details on errors.

Interpreting Error Descriptions

The items that are used to describe individual errors (events) are described in the following copy of an error table.

Event name	Gives the name of the error.		Event code	Gives the code of the error.		
Meaning	Gives a short description of the error.					
Source	Gives the source of the error.		Source details	Gives details on the source of the error.	Detection timing	Tells when the error is detected.
Error attributes	Level	Tells the level of influence on control. ^{*1}	Recovery	Gives the recovery method. ^{*2}	Log category	Tells which log the error is saved in. ^{*3}
Effects	User program	Tells what will happen to execution of the user program. ^{*4}	Operation	Provides special information on the operation that results from the error.		
Indicators	This is the status of the indicators for the EtherCAT port that is built into the NJ-series Controller. Indicator status is given only for errors in the EtherCAT Master Function Module and the EtherNet/IP Function Module.					
System-defined variables	Variable	Data type		Name		
	Lists the variable names, data types, and meanings for system-defined variables that provide direct error notification, that are directly affected by the error, or that contain settings that cause the error.					
Cause and correction	Assumed cause		Correction		Prevention	
	Lists the possible causes, corrections, and preventive measures for the error.					
Attached information	This is the attached information that is displayed by the Sysmac Studio or an NS-series PT.					
Precautions/Remarks	Provides precautions, restrictions, and supplemental information.					

*1: One of the following:

- Major fault: Major fault level
- Partial fault: Partial fault level
- Minor fault: Minor fault level
- Observation
- Information

*2: One of the following:

- Automatic recovery: Normal status is restored automatically when the cause of the error is removed.
- Error reset: Normal status is restored when the error is reset after the cause of the error is removed.
- Cycle the power supply: Normal status is restored when the power supply to the Controller is turned OFF and then back ON after the cause of the error is removed.
- Controller reset: Normal status is restored when the Controller is reset after the cause of the error is removed.
- Depends on cause: The recovery method depends on the cause of the error.

*3: One of the following:

- System: System event log
- Access: Access event log

*4: One of the following:

- Continues: Execution of the user program will continue.
- Stops: Execution of the user program stops.
- Starts: Execution of the user program starts.

Error Descriptions

Event name	Fan/Power Supply Error			Event code	08210000 hex	
Meaning	An error occurred in the fan or power supply.					
Source	EtherCAT Master Function Module		Source details	Slave	Detection timing	Always at startup
Error attributes	Level	Minor fault	Recovery	Error reset (after resetting the error in the slave)	Log category	System
Effects	User program	Continues.	Operation	All slave functionality stops until the problem is corrected.		
Indicators	EtherCAT NET RUN		EtherCAT NET ERR		EtherCAT LINK/ACT	
	---		---		---	
System-defined variables	Variable		Data type		Name	
	None		---		---	
Cause and correction	Assumed cause		Correction		Prevention	
	A foreign object is interfering with fan operation.		Turn OFF the power supply, remove the object interfering with fan operation, and turn the power supply back ON.		Make sure that there are no foreign objects interfering with fan operation.	
	A suitable power supply voltage is not being used, resulting in an overvoltage or undervoltage.		Turn OFF the power supply, replace the power supply with one with a suitable voltage, and turn the power supply back ON.		Use a power supply with a suitable voltage.	
Attached information	None					
Precautions/Remarks	If the problem persists after performing the corrections, a hardware failure may have occurred. Consult your OMRON representative.					

Event name	Camera Overcurrent Detected			Event code	08220000 hex	
Meaning	An overcurrent flowed to the Camera.					
Source	EtherCAT Master Function Module		Source details	Slave	Detection timing	Always at startup
Error attributes	Level	Minor fault	Recovery	Error reset (after resetting the error in the slave)	Log category	System
Effects	User program	Continues.	Operation	The Camera image will not be input, so measurements will be performed on invalid images. This may result in the output of unintentional measurement results.		
Indicators	EtherCAT NET RUN		EtherCAT NET ERR		EtherCAT LINK/ACT	
	---		---		---	
System-defined variables	Variable		Data type		Name	
	None		---		---	
Cause and correction	Assumed cause		Correction		Prevention	
	There is a short circuit inside the Camera cable or in a circuit inside the Controller.		Consult your OMRON representative.		Consult your OMRON representative.	
Attached information	None					
Precautions/Remarks	None					

Event name	Parallel I/O Overcurrent Detected			Event code	08230000 hex	
Meaning	An overcurrent occurred in the parallel I/O interface.					
Source	EtherCAT Master Function Module		Source details	Slave	Detection timing	Always at startup
Error attributes	Level	Minor fault	Recovery	Error reset (after resetting the error in the slave)	Log category	System
Effects	User program	Continues.	Operation	You cannot output measurement results to an external device with parallel I/O.		
Indicators	EtherCAT NET RUN		EtherCAT NET ERR		EtherCAT LINK/ACT	
	---		---		---	
System-defined variables	Variable		Data type		Name	
	None		---		---	
Cause and correction	Assumed cause		Correction		Prevention	
	A parallel I/O interface line is short-circuited.		Turn OFF the power supply and check the parallel I/O connections.		Wire the parallel I/O lines so that they do not become short-circuited.	
Attached information	None					
Precautions/Remarks	None					

Event name	Setting Data Load Error			Event code	182D0000 hex	
Meaning	Loading the scene group data failed.					
Source	EtherCAT Master Function Module		Source details	Slave	Detection timing	After turning ON slave power
Error attributes	Level	Minor fault	Recovery	Error reset (after resetting the error in the slave)	Log category	System
Effects	User program	Continues.	Operation	The Controller will start with the default scene group data. If the data is saved to the Controller in this condition, the previous scene group data will be overwritten.		
Indicators	EtherCAT NET RUN		EtherCAT NET ERR		EtherCAT LINK/ACT	
	---		---		---	
System-defined variables	Variable		Data type		Name	
	None		---		---	
Cause and correction	Assumed cause		Correction		Prevention	
	The data is corrupted because the power supply was turned OFF while saving the previous scene data.		Reset the scene to switch to.		Do not turn OFF the power supply during save processing for the scene data.	
	As the result of changing the operation mode, the required amount of memory increased, resulting in insufficient memory.		Change the measurement flow to reduce memory usage.		Change the measurement flow to reduce memory usage.	
Attached information	None					
Precautions/Remarks	None					

Event name	Change in Connected Camera		Event code	385A0000 hex		
Meaning	The Camera that is connected is different from when data was last saved.					
Source	EtherCAT Master Function Module		Source details	Slave	Detection timing	After turning ON slave power
Error attributes	Level	Minor fault	Recovery	Error reset (after resetting the error in the slave)	Log category	System
Effects	User program	Continues.	Operation	The Camera image can be input, but an unintentional number of Camera pixels, color, or monochrome information may be measured.		
Indicators	EtherCAT NET RUN		EtherCAT NET ERR		EtherCAT LINK/ACT	
	---		---		---	
System-defined variables	Variable		Data type		Name	
	None		---		---	
Cause and correction	Assumed cause		Correction		Prevention	
	The Camera connection information in the scene data does not agree with the connection information for the Camera connected to the Controller.		Connect a Camera that agrees with the Camera connection information in the scene data or edit the scene data according to the connection information for the Camera connected to the Controller.		Make sure that the Camera connection information in the scene data agrees with the connection information for the Camera connected to the Controller.	
Attached information	None					
Precautions/Remarks	This error will occur if you load system and scene group 0 data (bkd file) that was edited with simulation software to the Controller. Save the data to the Controller and restart the Controller.					

Event name	Camera Connection Error			Event code	38590000 hex	
Meaning	The Camera connection is wrong.					
Source	EtherCAT Master Function Module		Source details	Slave	Detection timing	Always at startup
Error attributes	Level	Minor fault	Recovery	Error reset (after resetting the error in the slave)	Log category	System
Effects	User program	Continues.	Operation	The Camera image will not be input, so measurements will be performed on invalid images. This may result in the output of unintentional measurement results.		
Indicators	EtherCAT NET RUN		EtherCAT NET ERR		EtherCAT LINK/ACT	
	---		---		---	
System-defined variables	Variable		Data type		Name	
	None		---		---	
Cause and correction	Assumed cause		Correction		Prevention	
	A Camera is not connected to the Controller.		Turn OFF the power supply, correctly connect a Camera to the Controller, and turn the power supply back ON.		Correctly connect a Camera to the Controller and tighten the screws.	
	The Camera cable is broken.		Turn OFF the power supply, replace the Camera cable with a new one, and turn the power supply back ON.		Use a flexible cable or take other measures to prevent the Camera cable from becoming broken.	
	The Camera Selection settings are not correct in the Camera Image Input and Camera Switching processing items.		Make suitable settings according to the connected Cameras.		Make suitable settings according to the connected Cameras.	
	A Camera is not connected to the Camera port on the Controller according to the Camera Selection settings in the Camera Image Input and Camera Switching processing items.		Turn OFF the power supply, connect a Camera to the suitable Camera port, and turn the power supply back ON.		Connect a Camera to the suitable Camera port.	
Attached information	None					
Precautions/Remarks	None					

Event name	System Error			Event code	48020000 hex	
Meaning	An error occurred in the system.					
Source	EtherCAT Master Function Module		Source details	Slave	Detection timing	Always at startup
Error attributes	Level	Minor fault	Recovery	Error reset (after resetting the error in the slave)	Log category	System
Effects	User program	Continues.	Operation	All slave functionality stops, and measurement trigger signals and commands are not acknowledged.		
Indicators	EtherCAT NET RUN		EtherCAT NET ERR		EtherCAT LINK/ACT	
	---		---		---	
System-defined variables	Variable		Data type		Name	
	None		---		---	
Cause and correction	Assumed cause		Correction		Prevention	
	A serious error occurred in the system in the Controller.		Consult your OMRON representative.		Consult your OMRON representative.	
Attached information	None					
Precautions/Remarks	None					

Event name	Output Control Timeout for Parallel I/O, PLC Link, or Ether-Net/IP		Event code	5821 0000 hex		
Meaning	A timeout occurred in data output handshaking control for measurement results.					
Source	EtherCAT Master Function Module		Source details	Slave	Detection timing	At measurement result output
Error attributes	Level	Minor fault	Recovery	Error reset (after resetting the error in the slave)	Log category	System
Effects	User program	Continues.	Operation	The most recent measurement results data will be corrupted.		
Indicators	EtherCAT NET RUN		EtherCAT NET ERR		EtherCAT LINK/ACT	
	---		---		---	
System-defined variables	Variable		Data type		Name	
	None		---		---	
Cause and correction	Assumed cause		Correction		Prevention	
	The data output handshaking controls in the program (i.e., the ON/OFF timing of the Result Set Request signal) are not correct.		Correct the data output handshaking controls in the program (i.e., the ON/OFF timing of the Result Set Request signal).		Create suitable data output handshaking controls in the program (i.e., the ON/OFF timing of the Result Set Request signal).	
	The output control timeout time is too short in comparison with the program processing time.		Correct the timeout time so that it is suitable for the program processing time.		Set the timeout time so that it is suitable for the program processing time.	
	There is a wiring mistake in the parallel I/O DSA or GATE signal.		Turn OFF the power supply, correctly wire the parallel I/O DSA or GATE signal, and restart the Unit.		Correctly wire the parallel I/O DSA or GATE signal.	
Attached information	None					
Precautions/Remarks	This error occurs when measurement results are output on the parallel I/O, PLC Link, or EtherNet/IP. For EtherCAT, refer to the Output Control Timeout for EtherCAT event.					

Event name	Output Control Timeout for EtherCAT		Event code	58220000 hex		
Meaning	A timeout occurred in data output handshaking control for measurement results.					
Source	EtherCAT Master Function Module		Source details	Slave	Detection timing	At measurement result output
Error attributes	Level	Minor fault	Recovery	Error reset (after resetting the error in the slave)	Log category	System
Effects	User program	Continues.	Operation	Data is not output to the EtherCAT master and it is stored in the Sensor. When the Result Set Request signal turns ON, the stored data is output to the EtherCAT master.		
Indicators	EtherCAT NET RUN		EtherCAT NET ERR		EtherCAT LINK/ACT	
	---		---		---	
System-defined variables	Variable		Data type		Name	
	None		---		---	
Cause and correction	Assumed cause		Correction		Prevention	
	The data output handshaking controls in the program (i.e., the ON/OFF timing of the Result Set Request signal) are not correct.		Correct the data output handshaking controls in the program (i.e., the ON/OFF timing of the Result Set Request signal).		Write suitable data output handshaking controls in the program (i.e., the ON/OFF timing of the Result Set Request signal).	
	The output control timeout time is too short in comparison with the program processing time.		Correct the timeout time so that it is suitable for the program processing time.		Set the timeout time so that it is suitable for the program processing time.	
Attached information	None					
Precautions/Remarks	This error occurs when measurement results are output on EtherCAT. For parallel I/O, PLC Link, or EtherNet/IP, refer to the Output Control Timeout for Parallel I/O, PLC Link, or EtherNet/IP event.					

Event name	Logging Disk Write Error		Event code	78190000 hex		
Meaning	Writing data to the logging disk failed.					
Source	EtherCAT Master Function Module		Source details	Slave	Detection timing	When logging images and logging operations
Error attributes	Level	Minor fault	Recovery	Error reset (after resetting the error in the slave)	Log category	System
Effects	User program	Continues.	Operation	Logging will not be possible until the problem is corrected.		
Indicators	EtherCAT NET RUN		EtherCAT NET ERR		EtherCAT LINK/ACT	
	---		---		---	
System-defined variables	Variable		Data type		Name	
	None		---		---	
Cause and correction	Assumed cause		Correction		Prevention	
	A logging disk is not inserted.		Insert a logging disk.		Insert the logging disk so that it will not come out.	
	The available space on the logging disk is not sufficient.		Delete unnecessary files from the logging disk or otherwise increase the available space.		Delete unnecessary files from the logging disk or otherwise increase the available space.	
	There is no logging folder.		Create the logging folder or change the logging folder.		Create the logging folder or change the logging folder.	
	Security restrictions are set on the logging disk.		Clear the security restrictions on the logging disk.		Clear the security restrictions on the logging disk.	
Attached information	None					
Precautions/Remarks	This event occurs only for image logging/operation logging. Data logging does not trigger this event.					

Event name	Setting Data Transfer Error			Event code	781A0000 hex	
Meaning	An error occurred while transferring the scene data.					
Source	EtherCAT Master Function Module		Source details	Slave	Detection timing	After editing scene data
Error attributes	Level	Minor fault	Recovery	Error reset (after resetting the error in the slave)	Log category	System
Effects	User program	Continues.	Operation	Measurements will be performed without using the edited scene data.		
Indicators	EtherCAT NET RUN		EtherCAT NET ERR		EtherCAT LINK/ACT	
	---		---		---	
System-defined variables	Variable		Data type		Name	
	None		---		---	
Cause and correction	Assumed cause		Correction		Prevention	
	Scene data was edited when there was little available space on the RAM disk and the operation mode was Double Speed Multi-input.		Clean up the contents of the RAM disk to create more available space.		Always make sure there is sufficient available space on the RAM disk for the current size of scene group data.	
	The data transfer button was clicked when there was little available space on the RAM disk and the operation mode was Non-stop Adjustment Mode.		Clean up the contents of the RAM disk to create more available space.		Always make sure there is sufficient available space on the RAM disk for the current size of scene group data.	
Attached information	None					
Precautions/Remarks	The RAM disk is used as a buffer when the operation mode is Double Speed Multi-input or Non-stop Adjustment Mode. Always ensure that there is enough available space for the current size of the scene group data.					

Event name	Output Buffer Error (EtherCAT)			Event code	781B0000 hex	
Meaning	The data output buffer for measurement data is full.					
Source	EtherCAT Master Function Module		Source details	Slave	Detection timing	At measurement result output
Error attributes	Level	Minor fault	Recovery	Error reset (after resetting the error in the slave)	Log category	System
Effects	User program	Continues.	Operation	The most recent measurement results data will be corrupted until there is space available in the data output buffer.		
Indicators	EtherCAT NET RUN		EtherCAT NET ERR		EtherCAT LINK/ACT	
	---		---		---	
System-defined variables	Variable		Data type		Name	
	None		---		---	
Cause and correction	Assumed cause		Correction		Prevention	
	Data measurements are being performed on a period that is shorter than the time that is required for data output handshake controls in the program.		Correct the program so that the period for performing measurements is slower than the time that is required for data output handshaking controls.		Write the program so that the period for performing measurements is slower than the time that is required for data output handshaking controls.	
Attached information	None					
Precautions/Remarks	The EtherCAT measurement result data buffer is 4 KB. If the size for one field bus data output processing unit is 32 bytes (eight DINT data items), the buffer can store data for up to 127 measurements.					

Event name	PLC Link Communications Error			Event code	88080000 hex	
Meaning	A PLC Link cannot be established.					
Source	EtherCAT Master Function Module		Source details	Slave	Detection timing	Always at startup
Error attributes	Level	Minor fault	Recovery	Error reset (after resetting the error in the slave)	Log category	System
Effects	User program	Continues.	Operation	You cannot control the Vision Sensor with the PLC Link.		
Indicators	EtherCAT NET RUN		EtherCAT NET ERR		EtherCAT LINK/ACT	
	---		---		---	
System-defined variables	Variable		Data type		Name	
	None		---		---	
Cause and correction	Assumed cause		Correction		Prevention	
	There is a mistake in the PLC or Vision Sensor communications settings.		Correct the communications settings in the PLC or Vision Sensor.		Correct the communications settings in the PLC or Vision Sensor.	
	The Ethernet or RS-232C cable is damaged.		Replace the Ethernet or RS-232C cable with a new one.		Use a flexible cable or take other measures to prevent the Ethernet or RS-232C cable from becoming broken.	
Attached information	None					
Precautions/Remarks	You can download the PLC Link Connection Guide from your OMRON website.					

Event name	Light installation error			Event code	385B0000 hex	
Meaning	The Light installation is incorrect.					
Source	EtherCAT Master Function Module		Source details	Slave	Detection timing	After turning ON slave power
Error attributes	Level	Minor fault	Recovery	Error reset (after resetting the error in the slave)	Log category	System
Effects	User program	Continues.	Operation	The light does not turn on.		
Indicators	EtherCAT NET RUN		EtherCAT NET ERR		EtherCAT LINK/ACT	
	---		---		---	
System-defined variables	Variable		Data type		Name	
	None		---		---	
Cause and correction	Assumed cause		Correction		Prevention	
	The power consumption of the light installed onto a camera with a Lighting Controller is incorrect.		Install a light whose power consumption is appropriate for the camera with a Lighting Controller.		Consult the instruction manual for the light and confirm that its power consumption is appropriate for the camera with a Lighting Controller.	
	The lighting mode of the light installed onto a camera with a Lighting Controller is incorrect.		Set an appropriate lighting mode for the light installed onto a camera with a Lighting Controller.		Consult the <i>FH/FZ5 Series Vision System Processing Item Function Reference Manual</i> (Cat. No. Z341-E1), and confirm the appropriate lighting mode for the installed light.	
	No external power supply is connected to the camera with a Lighting Controller.		Connect an external power supply to the camera with a Lighting Controller.		Confirm that the cable of an external power supply is connected.	
Attached information	None					
Precautions/Remarks	None					

Event name	Initial scene group error			Event code	58230000 hex	
Meaning	Initial scene group setting is incorrect.					
Source	EtherCAT Master Function Module		Source details	Slave	Detection timing	After turning ON slave power
Error attributes	Level	Minor fault	Recovery	Error reset (after resetting the error in the slave)	Log category	System
Effects	User program	Continues.	Operation	The whole slave operation suspends until a corrective action is taken.		
Indicators	EtherCAT NET RUN		EtherCAT NET ERR		EtherCAT LINK/ACT	
	---		---		---	
System-defined variables	Variable		Data type		Name	
	None		---		---	
Cause and correction	Assumed cause		Correction		Prevention	
	The external storage specified as the scene group destination by the Scene Group Saving Destination Settings tool is not connected at the time of startup.		Connect the specified external storage.		Confirm that the external storage is connected, and restart the controller.	
	The destination directory is not detected at the time of startup.		Select other directory in the connected external storage under the Scene Group Saving Destination Setting section on the Scene Group Saving Destination Settings dialog box.		Use the external storage where the specified destination directory is.	
	Initial scene group number is not within the range of scene group accepted by the system.		Correct the initial scene group number, save, and restart the controller.		Confirm that the initial scene group number is correct, save, and restart the controller.	
Attached information	None					
Precautions/Remarks	None					

Event name	Initial scene number error			Event code	58240000 hex	
Meaning	Initial scene number setting is incorrect.					
Source	EtherCAT Master Function Module		Source details	Slave	Detection timing	After turning ON slave power
Error attributes	Level	Minor fault	Recovery	Error reset (after resetting the error in the slave)	Log category	System
Effects	User program	Operation	Operation	The whole slave operation suspends until a corrective action is taken.		
Indicators	EtherCAT NET RUN		EtherCAT NET ERR		EtherCAT LINK/ACT	
	---		---		---	
System-defined variables	Variable		Data type		Name	
	None		---		---	
Cause and correction	Assumed cause		Correction		Prevention	
	Initial scene number is not within the range of scenes accepted by the system.		Correct the initial scene number, save, and restart the controller.		Confirm that the initial scene number is correct, save, and restart the controller.	
Attached information	None					
Precautions/Remarks	None					

Sysmac Device Features

The control device product designed according to standardized communications and user interface specifications for OMRON control devices are called a Sysmac Device.

And the features available with such a Device is called Sysmac Device Features.

This section describes the features the FH series Vision Sensor provides when combined with a Machine Automation Controller such as NJ series and automation software.

Sysmac Error Status

Because, in Sysmac Devices, errors that may occur in slaves are systematized, you can check the causes and remedies for errors with a common procedure.

The status of an error can be monitored in the Sysmac Error Status (2002-01 hex). To display the error status detected by the FH series Vision Sensor in Sysmac Studio, the Sysmac Error Status (2002-01 hex) must be mapped to the PDO. Sysmac Studio, by default, uses the 512th transmit PDO Mapping assignment to map the Sysmac Error Status (2002-01 hex) automatically to the PDO.

Note

- For the Sysmac Error status (2002-01 hex), refer to ► Object Dictionary Area (p.112).
- For errors displayed in Sysmac Studio, refer to ► *NJ-series Troubleshooting Manual* (Cat. No. W503-E1-07 or later).

Saving the Node Address Setting

When the node address switch setting is "00" (Software Setup mode), the node address value you set in Sysmac Studio is enabled. If the node address switches are set to any other value, the value that is set on the switches is used as the node address.

In the Software Setup mode, in Sysmac Studio, execute [Write Slave Node Address] on the [EtherCAT Edit] screen to save the slave node address setting in the nonvolatile memory of the FH series Vision Sensor.

• Software Setting

The set value saved as Slave Information Interface (SII) information in the nonvolatile memory of the slave is the node address.

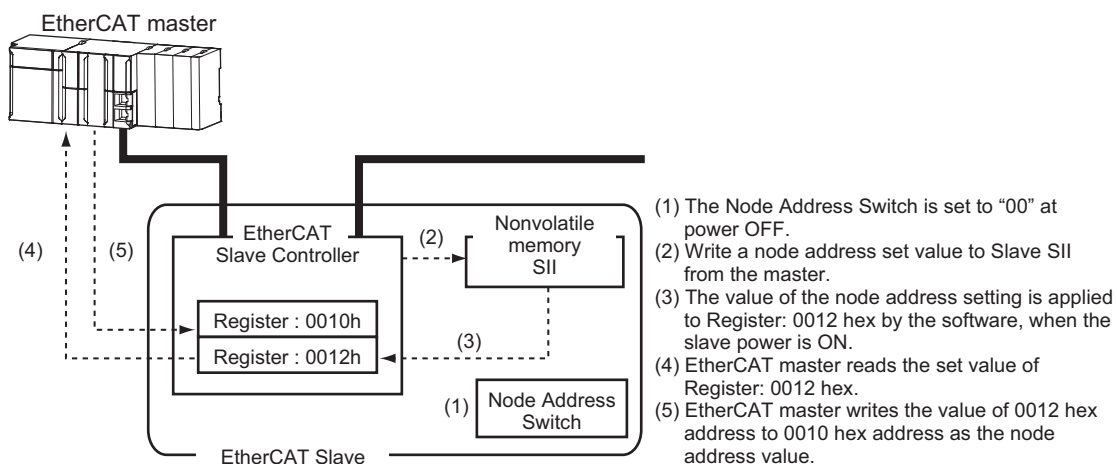

• Node Address Switch Setting

The value set on the node address switches is the node address.

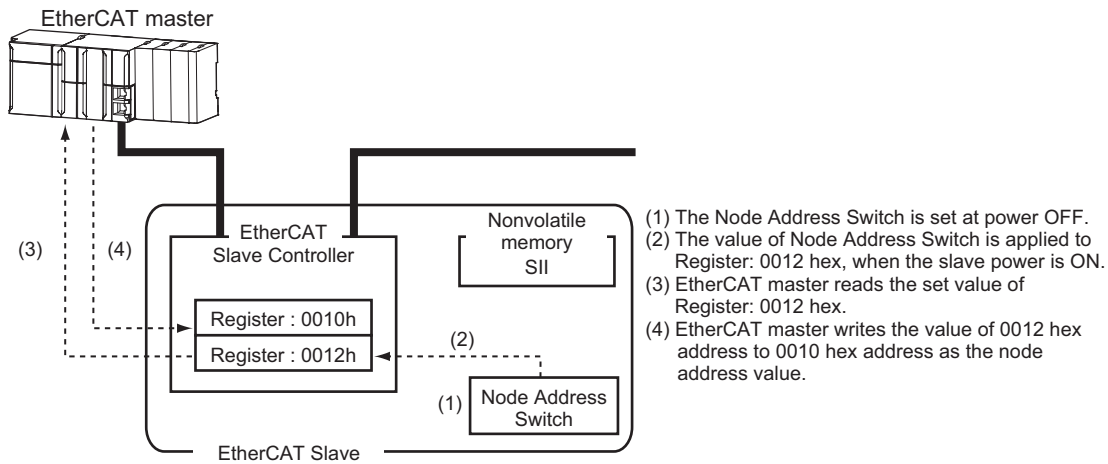

Serial Number Display

The serial number saved in the nonvolatile memory of the Vision Sensor is displayed in the Serial Number (1018-04 hex). Controllers that support Sysmac Device Features can use this serial number to check the network configuration. To enable this check, in Sysmac Studio, set [Serial No. Check Condition] to [Set Value = Actual Unit] on the [EtherCAT Edit] screen. If the set condition is not met, a Network Configuration Check Error will occur.

Note

The network configuration check detects any slave devices that have been replaced, which prevents you from forgetting to set parameters on those slaves.

Compliance with ESI Specification (ETG.2000 S (R) V1.0.1)

The ESI Specification is a set of specifications that define the entries required in an EtherCAT Slave Information (ESI) file.

SII Data Check

The Slave Information Interface (SII) is an interface area in the nonvolatile memory of an EtherCAT slave that stores the configuration information specific to that EtherCAT slave.

Sysmac Device EtherCAT slaves check the SII information from the slave side.

If one of these slaves finds that SII information with which it cannot operate was written, it generates an SII Check Error (Error No. 88.3). If this error persists even after turning OFF and then ON the power again, contact your OMRON sales representative.

IMPORTANT

Do not use third-party or any other configuration tools to edit the SII information.

Object Dictionary

The CAN application protocol over EtherCAT (CoE) protocol is based on the object dictionary of the CAN application protocol. This section describes the object dictionary and each object.

Object Dictionary Area

Each object is assigned with an index of four-digit hexadecimal value. The indexes are configured in the areas below.

Indexes	Area	Contents
0000 hex to 0FFF hex	Data Type area	Definitions of data types
1000 hex to 1FFF hex	CoE Communications area	Definitions of variables that can be used by all servers for designated communications
2000 hex to 2FFF hex	Manufacturer Specific area 1	Variables defined for all OMRON products
3000 hex to 5FFF hex	Manufacturer Specific area 2	Variables defined for FH series EtherCAT Slave Units Command/Response method with using message communication (SDO)
6000 hex to 6FFF hex	Input Area	Objects mapped to transmit PDOs
7000 hex to 7FFF hex	Output Area	Objects mapped to receive PDOs
8000 hex to 8FFF hex	Configuration Area	Objects for configurations and settings
9000 hex to 9FFF hex	Information Area	Not used. (Not supported.)
A000 hex to AFFF hex	Diagnosis Area	Not used. (Not supported.)
B000 hex to BFFF hex	Send Service Area	Not used. (Not supported.)
C000 hex to EFFF hex	Reserved area	Area reserved for future use
F000 hex to FFFF hex	Device Profile area	Parameters that belong to devices

Data Types

This profile uses the following data types.

Data Types	Code	Size	Range
Boolean	BOOL	1 bit	true(1), false(0)
Unsigned8	U8	1 byte	0 to 255
Unsigned16	U16	2 bytes	0 to 65535
Unsigned32	U32	4 bytes	0 to 4294967295
Integer8	INT8	1 byte	-128 to 127
Integer16	INT16	2 bytes	-32768 to 32767
Integer32	INT32	4 bytes	-2147483648 to 2147483647
Visible string	VS	---	---
Double	Double	8 bytes	-1.79769313486231e+308 to 1.79769313486231e+308

Object Description Format

In this manual, objects are described in the following format.

Object description format

<Index>	<Object name>		
Range: <Setting range>	Unit: <Unit>	Default: <Default setting>	Attribute: <Data attribute>
Size: <Size>	Access: <Access>	PDO map: <Possible/Not possible>	

Object description format with sub-indexes

<Index>	<Object name>		
Sub-index 0			
Range: <Setting range>	Unit: <Unit>	Default: <Default setting>	Attribute: <Data attribute>
Size: <Size>	Access: <Access>	PDO map: <Possible/Not possible>	
•			
•			
•			
Sub-index N			
Range: <Setting range>	Unit: <Unit>	Default: <Default setting>	Attribute: <Data attribute>
Size: <Size>	Access: <Access>	PDO map: <Possible/Not possible>	

The following values are indicated within the pointed brackets <>.

- Indexes : An object index given by a four-digit hexadecimal number
- Object name : The object name
- Range : The possible range of settings
- Unit : Physical unit
- Default : Default value set before product shipment
- Attribute : The timing when a change is updated in a writable object
 - A: Always enabled
 - B: Timing of count stop → operation (Encoder Input Slave Unit only)
 - C: Timing of pre-operational state → safe-operational state
 - D: Timing of pre-operational state → init state
 - R: Updated after the power supply is reset
 - : Read only
- Size : The object size is given in bytes
- Access : Indicates whether the object is read only, or read and write
 - RO: Read only
 - RW: Read and write
- PDO map : Indicates the PDO mapping possibility

Communication Objects

1000 hex	Device Type		
Range: –	Unit: –	Default: 00000000 hex	Attribute: –
Size: 4 bytes (U32)	Access: RO	PDO map: Not possible	

- The FH series Vision Sensors do not have a device profile.

1001 hex	Error Register		
Range: –	Unit: –	Default: 00 hex	Attribute: –
Size: 1 byte (U8)	Access: RO	PDO map: Not possible	

- Indicates the error type that occurs in a Slave Unit.

Bits	Name	Bits	Name
0	Generic error	4	Communications error
1	Current error	5	Device profile specific error
2	Voltage error	6	(Reserved)
3	Temperature error	7	Manufacturer specific error

1008 hex	Manufacturer Device Name		
Range: –	Unit: –	Default: Differ by Slave Unit types* ¹	Attribute: –
Size: 20 bytes (VS)	Access: RO	PDO map: Not possible	

- Indicates the Slave Unit model number.

1009 hex	Manufacturer Hardware Version		
Range: –	Unit: –	Default: Differ by Slave Unit types* ¹	Attribute: –
Size: 20 bytes (VS)	Access: RO	PDO map: Not possible	

- Indicates the version of the Slave Unit hardware.

100A hex	Manufacturer Software Version		
Range: –	Unit: –	Default: Differ by Slave Unit types* ¹	Attribute: –
Size: 20 bytes (VS)	Access: RO	PDO map: Not possible	

- Indicates the version of the Slave Unit software

*1: The default settings for the manufacture device name, manufacture hardware version, and manufacture software version are shown below for each slave.

Slave	Manufacture device name	Manufacture hardware version	Manufacture software version
FH-1050	FH-1050	V1.00 fifteen spaces (20 hex) (Fifteen space characters are filled after the hardware version "V1.00")	V5.XX
FH-1050-10	FH-1050-10		(The FH/FZ5 software version*, which consists of nineteen characters, follows after letter "V". If the length of the software version string is less than nineteen characters, spaces (20 hex) are filled until the version string length becomes nineteen.)
FH-1050-20	FH-1050-20		
FH-3050	FH-3050		
FH-3050-10	FH-3050-10		
FH-3050-20	FH-3050-20		

* : The software version refers to the version displayed in the [System information] dialog box.

1011 hex	Restore Default Parameters		
Sub-index 0: Number of entries			
Range: –	Unit: –	Default: 01 hex	Attribute: –
Size: 1 byte (U8)	Access: RO	PDO map: Not possible	
Sub-index 1: Restore Default Parameters			
Range: –	Unit: –	Default: 00000001 hex	Attribute: A
Size: 4 bytes (U32)	Access: RW	PDO map: Not possible	
<ul style="list-style-type: none"> Resets the parameters to their default values. The parameter is reset only when a specific value is written to sub-index 1. This prevents parameter values from being accidentally overwritten. The specific value is "load". 			
MSB		LSB	
d	a	o	l
64 hex	61 hex	6F hex	6C hex
<ul style="list-style-type: none"> The ABORT code is displayed if a value other than the specific is written. A value 0000 0001 hex (command valid) is indicated when reading. The FH series Vision Sensors do not support this parameter. 			
1018 hex	Identity Object		
Sub-index 0: Number of entries			
Range: –	Unit: –	Default: 04 hex	Attribute: –
Size: 1 byte (U8)	Access: RO	PDO map: Not possible	
Sub-index 1: Vendor ID			
Range: –	Unit: –	Default: 00000083 hex	Attribute: –
Size: 4 bytes (U32)	Access: RO	PDO map: Not possible	
Sub-index 2: Product Code			
Range: –	Unit: –	Default: Differ by Slave Unit types ^{*1}	Attribute: –
Size: 4 bytes (U32)	Access: RO	PDO map: Not possible	
Sub-index 3: Revision Number			
Range: –	Unit: –	Default: Differ by Slave Unit types ^{*1}	Attribute: –
Size: 4 bytes (U32)	Access: RO	PDO map: Not possible	
Sub-index 4: Serial Number			
Range: –	Unit: –	Default: Each Unit	Attribute: –
Size: 4 bytes (U32)	Access: RO	PDO map: Not possible	

- Indicates the device information.
- Sub-index 1 (Vendor ID) gives the manufacturer identifier.
- Sub-index 2 (Product Code) gives the value assigned to each Slave Unit type.
- Sub-index 3 (Revision Number) gives the Unit revision number.
- Bits 0 to 15: Minor revision number of the device
- Bits 16 to 31: Major revision number of the device
- Sub-index 4 (Serial Number) gives a serial number for each product.

*1: The values of sub-index 2 (Product Code) and sub-index 3 (Revision Number) of the Identity Object are indicated below for each slave.

Slave	Product Code(hex)	Revision Number(hex)
FH-1050	000000A0	00010000
FH-1050-10	000000A1	00010000
FH-1050-20	000000A2	00010000
FH-3050	000000A3	00010000
FH-3050-10	000000A4	00010000
FH-3050-20	000000A5	00010000

10F3 hex	Diagnosis History		
Sub-index 0: Number of entries			
Range: –	Unit: –	Default: 0D hex	Attribute: –
Size: 1 byte (U8)	Access: RO	PDO map: Not possible	
Sub-index 1: Maximum Messages			
Range: –	Unit: –	Default: 00 hex	Attribute: –
Size: 1 byte (U8)	Access: RO	PDO map: Not possible	
Sub-index 2: Newest Message			
Range: –	Unit: –	Default: –	Attribute: –
Size: 1 byte (U8)	Access: RO	PDO map: Not possible	
Sub-index 5: Flags			
Range: 0000Hex-0001Hex	Unit: –	Default: 0000 hex	Attribute: –
Size: 2 bytes (U16)	Access: RW	PDO map: Not possible	
Sub-index 6 to 13: Diagnosis Message 1-8			
Range: –	Unit: –	Default: –	Attribute: –
Size: 23 bytes (VS)	Access: RO	PDO map: Not possible	

- This object indicates up to 8 diagnosis histories. It also sets whether to notify emergency messages or not.
- Sub-index 1 (Maximum Messages) gives the number of error messages.
- Sub-index 2 (Newest Messages) gives the sub-index number the latest message in the diagnosis history.
- Sub-index 5 (Flags) is the control flag of diagnosis history. It specifies whether or not to notify error messages via emergency messages. Setting 0001 hex means to notify. It is set to 0001 hex (Emergency notify) when power is turned ON. At startup, the setting is 0000 hex (no emergency notification).
- Sub-indexes 6 to 13 (Diagnosis messages 1 to 8) indicate the diagnosis history. From sub-index 6 (Diagnosis message 1) to sub-index 13 (Diagnosis message 8) are stored 8 errors. The 9th error and onward are stored from the sub-index 6 (Diagnosis message 1) again.
- The FH series Vision Sensors support only the flags.

PDO Mapping Object

Indexes 1600 hex to 17FF hex are used for Receive PDO mapping, and indexes 1A00 hex to 1BFF hex are used for Transmit PDO mapping. Sub-indexes after sub-index 1 provide information about the application object being mapped.

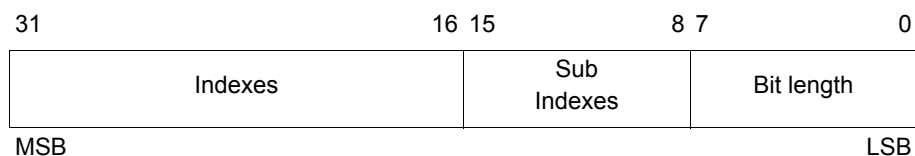

- Bits 0 to 7 : Bit length of the mapped object.
(For example, for 32 bits, 20 hex is given.)
- Bits 8 to 15 : Sub-index of the mapped object.
- Bits 16 to 31 : Index of the mapped object.

1600 hex	1st receive PDO Mapping		
Sub-index0: Number of objects			
Range: –	Unit: –	Default: 32 hex	
Size: 1 byte (U8)	Access: RO	PDO map: Not possible	
Sub-index1-32: 1st-32nd Output Object to be mapped			
Range: –	Unit: –	Default: 7000101/70000201/70000901/ 70001001/70001101 hex	
Size: 4 bytes (U32)	Access: RO	PDO map: Not possible	

- This object gives the mapping for an application that uses vision sensor functions.
- 7000 hex (Vision Control Flag) is mapped in 1 bytes.

1601 hex	2nd receive PDO Mapping		
Sub-index0: Number of objects			
Range: –	Unit: –	Default: 05 hex	
Size: 1 byte (U8)	Access: RO	PDO map: Not possible	
Sub-index1: 1st Output Object to be mapped			
Range: –	Unit: –	Default: 70010020 hex	
Size: 4 bytes (U32)	Access: RO	PDO map: Not possible	
Sub-index2: 2nd Output Object to be mapped			
Range: –	Unit: –	Default: 70020120 hex	
Size: 4 bytes (U32)	Access: RO	PDO map: Not possible	
Sub-index3: 3rd Output Object to be mapped			
Range: –	Unit: –	Default: 70020220 hex	
Size: 4 bytes (U32)	Access: RO	PDO map: Not possible	
Sub-index4: 4th Output Object to be mapped			
Range: –	Unit: –	Default: 70020320 hex	
Size: 4 bytes (U32)	Access: RO	PDO map: Not possible	
Sub-index5: 5th Output Object to be mapped			
Range: –	Unit: –	Default: 70020420 hex	
Size: 4 bytes (U32)	Access: RO	PDO map: Not possible	

- This object gives the mapping for an application that uses vision sensor functions.
- 7001 hex (Vision Command)
- 7002 hex (Vision Command Parameter1-3)

Objects are provided for each line as shown below when more than one line is used.

Line 1:1620 hex (1st receive PDO mapping) and 1621 hex (2nd receive PDO mapping)

Line 2:1640 hex (1st receive PDO mapping) and 1641 hex (2nd receive PDO mapping)

Line 3:1660 hex (1st receive PDO mapping) and 1661 hex (2nd receive PDO mapping)

Line 4:1680 hex (1st receive PDO mapping) and 1681 hex (2nd receive PDO mapping)

Line 5:16A0 hex (1st receive PDO mapping) and 16A1 hex (2nd receive PDO mapping)

Line 6:16C0 hex (1st receive PDO mapping) and 16C1 hex (2nd receive PDO mapping)

Line 7:16E0 hex (1st receive PDO mapping) and 16E1 hex (2nd receive PDO mapping)

1602 hex	3rd receive PDO Mapping		
Sub-index0: Number of objects			
Range: –	Unit: –	Default: 06 hex	
Size: 1 byte (U8)	Access: RO	PDO map: Not possible	
Sub-index1: 1st Output Object to be mapped			
Range: –	Unit: –	Default: 70030120 hex	
Size: 4 bytes (U32)	Access: RO	PDO map: Not possible	
Sub-index2: 2nd Output Object to be mapped			
Range: –	Unit: –	Default: 70030220 hex	
Size: 4 bytes (U32)	Access: RO	PDO map: Not possible	
Sub-index3: 3rd Output Object to be mapped			
Range: –	Unit: –	Default: 70030320 hex	
Size: 4 bytes (U32)	Access: RO	PDO map: Not possible	
Sub-index4: 4th Output Object to be mapped			
Range: –	Unit: –	Default: 70030420 hex	
Size: 4 bytes (U32)	Access: RO	PDO map: Not possible	
Sub-index5: 5th Output Object to be mapped			
Range: –	Unit: –	Default: 70030540 hex	
Size: 4 bytes (U32)	Access: RO	PDO map: Not possible	
Sub-index6: 6th Output Object to be mapped			
Range: –	Unit: –	Default: 70030640 hex	
Size: 4 bytes (U32)	Access: RO	PDO map: Not possible	

- This object gives the mapping for an application that uses vision sensor functions.
- 7001 hex (Vision Command)
- 7002 hex (Vision Command Parameter1-3)
- 7003 hex (User Input Area)

Objects are provided for each line as shown below when more than one line is used.

Line 1: 1620 hex (1st receive PDO mapping), 1621 hex (2nd receive PDO mapping) and 1622 hex (3rd receive PDO mapping)

Line 2: 1640 hex (1st receive PDO mapping), 1641 hex (2nd receive PDO mapping) and 1642 hex (3rd receive PDO mapping)

Line 3: 1660 hex (1st receive PDO mapping), 1661 hex (2nd receive PDO mapping) and 1662 hex (3rd receive PDO mapping)

Line 4: 1680 hex (1st receive PDO mapping), 1681 hex (2nd receive PDO mapping) and 1682 hex (3rd receive PDO mapping)

Line 5: 16A0 hex (1st receive PDO mapping), 16A1 hex (2nd receive PDO mapping) and 16A2 hex (3rd receive PDO mapping)

Line 6: 16C0 hex (1st receive PDO mapping), 16C1 hex (2nd receive PDO mapping) and 16C2 hex (3rd receive PDO mapping)

Line 7: 16E0 hex (1st receive PDO mapping), 16E1 hex (2nd receive PDO mapping) and 16E2 hex (3rd receive PDO mapping)

1A00 hex	1st transmit PDO Mapping		
Sub-index0: Number of objects			
Range: –	Unit: –	Default: 32 hex	
Size: 1 byte (U8)	Access: RO	PDO map: Not possible	
Sub-index1-32: 1st-32nd Input Object to be mapped			
Range: –	Unit: –	Default: 60000101/60000201/60000301/ 60000401/60000501/60000601/60000701/ 60000801/60000901/60000A01/60000B01/ 60001001/60001101 hex	
Size: 4 bytes (U32)	Access: RO	PDO map: Not possible	

- This object gives the mapping for an application that uses vision sensor functions.
- 6000h (Vision status Flag) is mapped in 1 bytes.

1A01 hex	2nd transmit PDO Mapping		
Sub-index0: Number of objects			
Range: –	Unit: –	Default: 03 hex	
Size: 1 byte (U8)	Access: RO	PDO map: Not possible	
Sub-index1: 1st Input Object to be mapped			
Range: –	Unit: –	Default: 60010020 hex	
Size: 4 bytes (U32)	Access: RO	PDO map: Not possible	
Sub-index2: 2nd Input Object to be mapped			
Range: –	Unit: –	Default: 60020120 hex	
Size: 4 bytes (U32)	Access: RO	PDO map: Not possible	
Sub-index3: 3rd Input Object to be mapped			
Range: –	Unit: –	Default: 60030120 hex	
Size: 4 bytes (U32)	Access: RO	PDO map: Not possible	

- This object gives the mapping for an application that uses vision sensor functions.
- 6001 hex (Echoback Command)
- 6002 hex (Response Code)
- 6003 hex (Response Data)

1A02 hex	3rd transmit PDO Mapping		
Sub-index0: Number of objects			
Range: –	Unit: –	Default: 01 hex	
Size: 1 byte (U8)	Access: RO	PDO map: Not possible	
Sub-index1: 1st Input Object to be mapped			
Range: –	Unit: –	Default: 60040020 hex	
Size: 4 bytes (U32)	Access: RO	PDO map: Not possible	

- This object gives the mapping for an application that uses vision sensor functions.
- 6004 hex (Error Code)

1A04 hex		5th transmit PDO Mapping	
Sub-index0: Number of objects			
Range: –	Unit: –	Default: 08 hex	
Size: 1 byte (U8)	Access: RO	PDO map: Not possible	
Sub-index1: 1st Input Object to be mapped			
Range: –	Unit: –	Default: 60050120 hex	
Size: 4 bytes (U32)	Access: RO	PDO map: Not possible	
Sub-index2: 2nd Input Object to be mapped			
Range: –	Unit: –	Default: 60050220 hex	
Size: 4 bytes (U32)	Access: RO	PDO map: Not possible	
Sub-index3: 3rd Input Object to be mapped			
Range: –	Unit: –	Default: 60050320 hex	
Size: 4 bytes (U32)	Access: RO	PDO map: Not possible	
Sub-index4: 4th Input Object to be mapped			
Range: –	Unit: –	Default: 60050420 hex	
Size: 4 bytes (U32)	Access: RO	PDO map: Not possible	
Sub-index5: 5th Input Object to be mapped			
Range: –	Unit: –	Default: 60050520 hex	
Size: 4 bytes (U32)	Access: RO	PDO map: Not possible	
Sub-index6: 6th Input Object to be mapped			
Range: –	Unit: –	Default: 60050620 hex	
Size: 4 bytes (U32)	Access: RO	PDO map: Not possible	
Sub-index7: 7th Input Object to be mapped			
Range: –	Unit: –	Default: 60050720 hex	
Size: 4 bytes (U32)	Access: RO	PDO map: Not possible	
Sub-index8: 8th Input Object to be mapped			
Range: –	Unit: –	Default: 60050820 hex	
Size: 4 bytes (U32)	Access: RO	PDO map: Not possible	

- This object gives the mapping for an application that uses vision sensor functions.
- 6005 hex (Image Processing Results Integer Data)

1A05 hex	6th transmit PDO Mapping		
Sub-index0: Number of objects			
Range: –	Unit: –	Default: 16 hex	
Size: 1 byte (U8)	Access: RO	PDO map: Not possible	
Sub-index1: 1st Input Object to be mapped			
Range: –	Unit: –	Default: 60050120 hex	
Size: 4 bytes (U32)	Access: RO	PDO map: Not possible	
Sub-index2: 2nd Input Object to be mapped			
Range: –	Unit: –	Default: 60050220 hex	
Size: 4 bytes (U32)	Access: RO	PDO map: Not possible	
Sub-index3: 3rd Input Object to be mapped			
Range: –	Unit: –	Default: 60050320 hex	
Size: 4 bytes (U32)	Access: RO	PDO map: Not possible	
Sub-index4: 4th Input Object to be mapped			
Range: –	Unit: –	Default: 60050420 hex	
Size: 4 bytes (U32)	Access: RO	PDO map: Not possible	
Sub-index5: 5th Input Object to be mapped			
Range: –	Unit: –	Default: 60050520 hex	
Size: 4 bytes (U32)	Access: RO	PDO map: Not possible	
Sub-index6: 6th Input Object to be mapped			
Range: –	Unit: –	Default: 60050620 hex	
Size: 4 bytes (U32)	Access: RO	PDO map: Not possible	
Sub-index7: 7th Input Object to be mapped			
Range: –	Unit: –	Default: 60050720 hex	
Size: 4 bytes (U32)	Access: RO	PDO map: Not possible	
Sub-index8: 8th Input Object to be mapped			
Range: –	Unit: –	Default: 60050820 hex	
Size: 4 bytes (U32)	Access: RO	PDO map: Not possible	
Sub-index9: 9th Input Object to be mapped			
Range: –	Unit: –	Default: 60050920 hex	
Size: 4 bytes (U32)	Access: RO	PDO map: Not possible	
Sub-index10: 10th Input Object to be mapped			
Range: –	Unit: –	Default: 60050A20 hex	
Size: 4 bytes (U32)	Access: RO	PDO map: Not possible	
Sub-index11: 11th Input Object to be mapped			
Range: –	Unit: –	Default: 60050B20 hex	
Size: 4 bytes (U32)	Access: RO	PDO map: Not possible	
Sub-index12: 12th Input Object to be mapped			
Range: –	Unit: –	Default: 60050C20 hex	
Size: 4 bytes (U32)	Access: RO	PDO map: Not possible	
Sub-index13: 13th Input Object to be mapped			
Range: –	Unit: –	Default: 60050D20 hex	
Size: 4 bytes (U32)	Access: RO	PDO map: Not possible	

Sub-index14: 14th Input Object to be mapped			
Range: –	Unit: –	Default: 60050E20 hex	
Size: 4 bytes (U32)	Access: RO	PDO map: Not possible	
Sub-index15: 15th Input Object to be mapped			
Range: –	Unit: –	Default: 60050F20 hex	
Size: 4 bytes (U32)	Access: RO	PDO map: Not possible	
Sub-index16: 16th Input Object to be mapped			
Range: –	Unit: –	Default: 60051020 hex	
Size: 4 bytes (U32)	Access: RO	PDO map: Not possible	

- This object gives the mapping for an application that uses vision sensor functions.
- 6005 hex (Image Processing Results Integer Data)

1A06 hex	7th transmit PDO Mapping		
Sub-index0: Number of objects			
Range: –	Unit: –	Default: 32 hex	
Size: 1 byte (U8)	Access: RO	PDO map: Not possible	
Sub-index1: 1st Input Object to be mapped			
Range: –	Unit: –	Default: 60050120 hex	
Size: 4 bytes (U32)	Access: RO	PDO map: Not possible	
Sub-index2: 2nd Input Object to be mapped			
Range: –	Unit: –	Default: 60050220 hex	
Size: 4 bytes (U32)	Access: RO	PDO map: Not possible	
Sub-index3: 3rd Input Object to be mapped			
Range: –	Unit: –	Default: 60050320 hex	
Size: 4 bytes (U32)	Access: RO	PDO map: Not possible	
Sub-index4: 4th Input Object to be mapped			
Range: –	Unit: –	Default: 60050420 hex	
Size: 4 bytes (U32)	Access: RO	PDO map: Not possible	
Sub-index5: 5th Input Object to be mapped			
Range: –	Unit: –	Default: 60050520 hex	
Size: 4 bytes (U32)	Access: RO	PDO map: Not possible	
Sub-index6: 6th Input Object to be mapped			
Range: –	Unit: –	Default: 60050620 hex	
Size: 4 bytes (U32)	Access: RO	PDO map: Not possible	
Sub-index7: 7th Input Object to be mapped			
Range: –	Unit: –	Default: 60050720 hex	
Size: 4 bytes (U32)	Access: RO	PDO map: Not possible	
Sub-index8: 8th Input Object to be mapped			
Range: –	Unit: –	Default: 60050820 hex	
Size: 4 bytes (U32)	Access: RO	PDO map: Not possible	
Sub-index9: 9th Input Object to be mapped			
Range: –	Unit: –	Default: 60050920 hex	
Size: 4 bytes (U32)	Access: RO	PDO map: Not possible	
Sub-index10: 10th Input Object to be mapped			
Range: –	Unit: –	Default: 60050A20 hex	
Size: 4 bytes (U32)	Access: RO	PDO map: Not possible	
Sub-index11: 11th Input Object to be mapped			
Range: –	Unit: –	Default: 60050B20 hex	
Size: 4 bytes (U32)	Access: RO	PDO map: Not possible	
Sub-index12: 12th Input Object to be mapped			
Range: –	Unit: –	Default: 60050C20 hex	
Size: 4 bytes (U32)	Access: RO	PDO map: Not possible	
Sub-index13: 13th Input Object to be mapped			
Range: –	Unit: –	Default: 60050D20 hex	
Size: 4 bytes (U32)	Access: RO	PDO map: Not possible	

Sub-index14: 14th Input Object to be mapped			
Range: –	Unit: –	Default: 60050E20 hex	
Size: 4 bytes (U32)	Access: RO	PDO map: Not possible	
Sub-index15: 15th Input Object to be mapped			
Range: –	Unit: –	Default: 60050F20 hex	
Size: 4 bytes (U32)	Access: RO	PDO map: Not possible	
Sub-index16: 16th Input Object to be mapped			
Range: –	Unit: –	Default: 60051020 hex	
Size: 4 bytes (U32)	Access: RO	PDO map: Not possible	
Sub-index17: 17th Input Object to be mapped			
Range: –	Unit: –	Default: 60051120 hex	
Size: 4 bytes (U32)	Access: RO	PDO map: Not possible	
Sub-index18: 18th Input Object to be mapped			
Range: –	Unit: –	Default: 60051220 hex	
Size: 4 bytes (U32)	Access: RO	PDO map: Not possible	
Sub-index19: 19th Input Object to be mapped			
Range: –	Unit: –	Default: 60051320 hex	
Size: 4 bytes (U32)	Access: RO	PDO map: Not possible	
Sub-index20: 20th Input Object to be mapped			
Range: –	Unit: –	Default: 60051420 hex	
Size: 4 bytes (U32)	Access: RO	PDO map: Not possible	
Sub-index21: 21st Input Object to be mapped			
Range: –	Unit: –	Default: 60051520 hex	
Size: 4 bytes (U32)	Access: RO	PDO map: Not possible	
Sub-index22: 22nd Input Object to be mapped			
Range: –	Unit: –	Default: 60051620 hex	
Size: 4 bytes (U32)	Access: RO	PDO map: Not possible	
Sub-index23: 23rd Input Object to be mapped			
Range: –	Unit: –	Default: 60051720 hex	
Size: 4 bytes (U32)	Access: RO	PDO map: Not possible	
Sub-index24: 24th Input Object to be mapped			
Range: –	Unit: –	Default: 60051820 hex	
Size: 4 bytes (U32)	Access: RO	PDO map: Not possible	
Sub-index25: 25th Input Object to be mapped			
Range: –	Unit: –	Default: 60051920 hex	
Size: 4 bytes (U32)	Access: RO	PDO map: Not possible	
Sub-index26: 26th Input Object to be mapped			
Range: –	Unit: –	Default: 60051A20 hex	
Size: 4 bytes (U32)	Access: RO	PDO map: Not possible	
Sub-index27: 27th Input Object to be mapped			
Range: –	Unit: –	Default: 60051B20 hex	
Size: 4 bytes (U32)	Access: RO	PDO map: Not possible	

Sub-index28: 28th Input Object to be mapped			
Range: –	Unit: –	Default: 60051C20 hex	
Size: 4 bytes (U32)	Access: RO	PDO map: Not possible	
Sub-index29: 29th Input Object to be mapped			
Range: –	Unit: –	Default: 60051D20 hex	
Size: 4 bytes (U32)	Access: RO	PDO map: Not possible	
Sub-index30: 30th Input Object to be mapped			
Range: –	Unit: –	Default: 60051E20 hex	
Size: 4 bytes (U32)	Access: RO	PDO map: Not possible	
Sub-index31: 31st Input Object to be mapped			
Range: –	Unit: –	Default: 60051F20 hex	
Size: 4 bytes (U32)	Access: RO	PDO map: Not possible	
Sub-index32: 32nd Input Object to be mapped			
Range: –	Unit: –	Default: 60052020 hex	
Size: 4 bytes (U32)	Access: RO	PDO map: Not possible	

- This object gives the mapping for an application that uses vision sensor functions.
- 6005 hex (Image Processing Results Integer Data)

1A07 hex	8th transmit PDO Mapping		
Sub-index0: Number of objects			
Range: –	Unit: –	Default: 64 hex	
Size: 1 byte (U8)	Access: RO	PDO map: Not possible	
Sub-index1: 1st Input Object to be mapped			
Range: –	Unit: –	Default: 60050120 hex	
Size: 4 bytes (U32)	Access: RO	PDO map: Not possible	
Sub-index2: 2nd Input Object to be mapped			
Range: –	Unit: –	Default: 60050220 hex	
Size: 4 bytes (U32)	Access: RO	PDO map: Not possible	
Sub-index3: 3rd Input Object to be mapped			
Range: –	Unit: –	Default: 60050320 hex	
Size: 4 bytes (U32)	Access: RO	PDO map: Not possible	
Sub-index4: 4th Input Object to be mapped			
Range: –	Unit: –	Default: 60050420 hex	
Size: 4 bytes (U32)	Access: RO	PDO map: Not possible	
Sub-index5: 5th Input Object to be mapped			
Range: –	Unit: –	Default: 60050520 hex	
Size: 4 bytes (U32)	Access: RO	PDO map: Not possible	
Sub-index6: 6th Input Object to be mapped			
Range: –	Unit: –	Default: 60050620 hex	
Size: 4 bytes (U32)	Access: RO	PDO map: Not possible	
Sub-index7: 7th Input Object to be mapped			
Range: –	Unit: –	Default: 60050720 hex	
Size: 4 bytes (U32)	Access: RO	PDO map: Not possible	
Sub-index8: 8th Input Object to be mapped			
Range: –	Unit: –	Default: 60050820 hex	
Size: 4 bytes (U32)	Access: RO	PDO map: Not possible	
Sub-index9: 9th Input Object to be mapped			
Range: –	Unit: –	Default: 60050920 hex	
Size: 4 bytes (U32)	Access: RO	PDO map: Not possible	
Sub-index10: 10th Input Object to be mapped			
Range: –	Unit: –	Default: 60050A20 hex	
Size: 4 bytes (U32)	Access: RO	PDO map: Not possible	
Sub-index11: 11th Input Object to be mapped			
Range: –	Unit: –	Default: 60050B20 hex	
Size: 4 bytes (U32)	Access: RO	PDO map: Not possible	
Sub-index12: 12th Input Object to be mapped			
Range: –	Unit: –	Default: 60050C20 hex	
Size: 4 bytes (U32)	Access: RO	PDO map: Not possible	

Sub-index13: 13th Input Object to be mapped			
Range: –	Unit: –	Default: 60050D20 hex	
Size: 4 bytes (U32)	Access: RO	PDO map: Not possible	
Sub-index14: 14th Input Object to be mapped			
Range: –	Unit: –	Default: 60050E20 hex	
Size: 4 bytes (U32)	Access: RO	PDO map: Not possible	
Sub-index15: 15th Input Object to be mapped			
Range: –	Unit: –	Default: 60050F20 hex	
Size: 4 bytes (U32)	Access: RO	PDO map: Not possible	
Sub-index16: 16th Input Object to be mapped			
Range: –	Unit: –	Default: 60051020 hex	
Size: 4 bytes (U32)	Access: RO	PDO map: Not possible	
Sub-index17: 17th Input Object to be mapped			
Range: –	Unit: –	Default: 60051120 hex	
Size: 4 bytes (U32)	Access: RO	PDO map: Not possible	
Sub-index18: 18th Input Object to be mapped			
Range: –	Unit: –	Default: 60051220 hex	
Size: 4 bytes (U32)	Access: RO	PDO map: Not possible	
Sub-index19: 19th Input Object to be mapped			
Range: –	Unit: –	Default: 60051320 hex	
Size: 4 bytes (U32)	Access: RO	PDO map: Not possible	
Sub-index20: 20th Input Object to be mapped			
Range: –	Unit: –	Default: 60051420 hex	
Size: 4 bytes (U32)	Access: RO	PDO map: Not possible	
Sub-index21: 21st Input Object to be mapped			
Range: –	Unit: –	Default: 60051520 hex	
Size: 4 bytes (U32)	Access: RO	PDO map: Not possible	
Sub-index22: 22nd Input Object to be mapped			
Range: –	Unit: –	Default: 60051620 hex	
Size: 4 bytes (U32)	Access: RO	PDO map: Not possible	
Sub-index23: 23rd Input Object to be mapped			
Range: –	Unit: –	Default: 60051720 hex	
Size: 4 bytes (U32)	Access: RO	PDO map: Not possible	
Sub-index24: 24th Input Object to be mapped			
Range: –	Unit: –	Default: 60051820 hex	
Size: 4 bytes (U32)	Access: RO	PDO map: Not possible	
Sub-index25: 25th Input Object to be mapped			
Range: –	Unit: –	Default: 60051920 hex	
Size: 4 bytes (U32)	Access: RO	PDO map: Not possible	
Sub-index26: 26th Input Object to be mapped			
Range: –	Unit: –	Default: 60051A20 hex	
Size: 4 bytes (U32)	Access: RO	PDO map: Not possible	

Sub-index27: 27th Input Object to be mapped			
Range: –	Unit: –	Default: 60051B20 hex	
Size: 4 bytes (U32)	Access: RO	PDO map: Not possible	
Sub-index28: 28th Input Object to be mapped			
Range: –	Unit: –	Default: 60051C20 hex	
Size: 4 bytes (U32)	Access: RO	PDO map: Not possible	
Sub-index29: 29th Input Object to be mapped			
Range: –	Unit: –	Default: 60051D20 hex	
Size: 4 bytes (U32)	Access: RO	PDO map: Not possible	
Sub-index30: 30th Input Object to be mapped			
Range: –	Unit: –	Default: 60051E20 hex	
Size: 4 bytes (U32)	Access: RO	PDO map: Not possible	
Sub-index31: 31st Input Object to be mapped			
Range: –	Unit: –	Default: 60051F20 hex	
Size: 4 bytes (U32)	Access: RO	PDO map: Not possible	
Sub-index32: 32nd Input Object to be mapped			
Range: –	Unit: –	Default: 60052020 hex	
Size: 4 bytes (U32)	Access: RO	PDO map: Not possible	
Sub-index33: 33rd Input Object to be mapped			
Range: –	Unit: –	Default: 60052120 hex	
Size: 4 bytes (U32)	Access: RO	PDO map: Not possible	
Sub-index34: 34th Input Object to be mapped			
Range: –	Unit: –	Default: 60052220 hex	
Size: 4 bytes (U32)	Access: RO	PDO map: Not possible	
Sub-index35: 35th Input Object to be mapped			
Range: –	Unit: –	Default: 60052320 hex	
Size: 4 bytes (U32)	Access: RO	PDO map: Not possible	
Sub-index36: 36th Input Object to be mapped			
Range: –	Unit: –	Default: 60052420 hex	
Size: 4 bytes (U32)	Access: RO	PDO map: Not possible	
Sub-index37: 37th Input Object to be mapped			
Range: –	Unit: –	Default: 60052520 hex	
Size: 4 bytes (U32)	Access: RO	PDO map: Not possible	
Sub-index38: 38th Input Object to be mapped			
Range: –	Unit: –	Default: 60052620 hex	
Size: 4 bytes (U32)	Access: RO	PDO map: Not possible	
Sub-index39: 39th Input Object to be mapped			
Range: –	Unit: –	Default: 60052720 hex	
Size: 4 bytes (U32)	Access: RO	PDO map: Not possible	
Sub-index40: 40th Input Object to be mapped			
Range: –	Unit: –	Default: 60052820 hex	
Size: 4 bytes (U32)	Access: RO	PDO map: Not possible	

Sub-index41: 41st Input Object to be mapped			
Range: –	Unit: –	Default: 60052920 hex	
Size: 4 bytes (U32)	Access: RO	PDO map: Not possible	
Sub-index42: 42nd Input Object to be mapped			
Range: –	Unit: –	Default: 60052A20 hex	
Size: 4 bytes (U32)	Access: RO	PDO map: Not possible	
Sub-index43: 43rd Input Object to be mapped			
Range: –	Unit: –	Default: 60052B20 hex	
Size: 4 bytes (U32)	Access: RO	PDO map: Not possible	
Sub-index44: 44th Input Object to be mapped			
Range: –	Unit: –	Default: 60052C20 hex	
Size: 4 bytes (U32)	Access: RO	PDO map: Not possible	
Sub-index45: 45th Input Object to be mapped			
Range: –	Unit: –	Default: 60052D20 hex	
Size: 4 bytes (U32)	Access: RO	PDO map: Not possible	
Sub-index46: 46th Input Object to be mapped			
Range: –	Unit: –	Default: 60052E20 hex	
Size: 4 bytes (U32)	Access: RO	PDO map: Not possible	
Sub-index47: 47th Input Object to be mapped			
Range: –	Unit: –	Default: 60052F20 hex	
Size: 4 bytes (U32)	Access: RO	PDO map: Not possible	
Sub-index48: 48th Input Object to be mapped			
Range: –	Unit: –	Default: 60053020 hex	
Size: 4 bytes (U32)	Access: RO	PDO map: Not possible	
Sub-index49: 49th Input Object to be mapped			
Range: –	Unit: –	Default: 60053120 hex	
Size: 4 bytes (U32)	Access: RO	PDO map: Not possible	
Sub-index50: 50th Input Object to be mapped			
Range: –	Unit: –	Default: 60053220 hex	
Size: 4 bytes (U32)	Access: RO	PDO map: Not possible	
Sub-index51: 51st Input Object to be mapped			
Range: –	Unit: –	Default: 60053320 hex	
Size: 4 bytes (U32)	Access: RO	PDO map: Not possible	
Sub-index52: 52nd Input Object to be mapped			
Range: –	Unit: –	Default: 60053420 hex	
Size: 4 bytes (U32)	Access: RO	PDO map: Not possible	
Sub-index53: 53rd Input Object to be mapped			
Range: –	Unit: –	Default: 60053520 hex	
Size: 4 bytes (U32)	Access: RO	PDO map: Not possible	
Sub-index54: 54th Input Object to be mapped			
Range: –	Unit: –	Default: 60053620 hex	
Size: 4 bytes (U32)	Access: RO	PDO map: Not possible	

Sub-index55: 55th Input Object to be mapped			
Range: –	Unit: –	Default: 60053720 hex	
Size: 4 bytes (U32)	Access: RO	PDO map: Not possible	
Sub-index56: 56th Input Object to be mapped			
Range: –	Unit: –	Default: 60053820 hex	
Size: 4 bytes (U32)	Access: RO	PDO map: Not possible	
Sub-index57: 57th Input Object to be mapped			
Range: –	Unit: –	Default: 60053920 hex	
Size: 4 bytes (U32)	Access: RO	PDO map: Not possible	
Sub-index58: 58th Input Object to be mapped			
Range: –	Unit: –	Default: 60053A20 hex	
Size: 4 bytes (U32)	Access: RO	PDO map: Not possible	
Sub-index59: 59th Input Object to be mapped			
Range: –	Unit: –	Default: 60053B20 hex	
Size: 4 bytes (U32)	Access: RO	PDO map: Not possible	
Sub-index60: 60th Input Object to be mapped			
Range: –	Unit: –	Default: 60053C20 hex	
Size: 4 bytes (U32)	Access: RO	PDO map: Not possible	
Sub-index61: 61st Input Object to be mapped			
Range: –	Unit: –	Default: 60053D20 hex	
Size: 4 bytes (U32)	Access: RO	PDO map: Not possible	
Sub-index62: 62nd Input Object to be mapped			
Range: –	Unit: –	Default: 60053E20 hex	
Size: 4 bytes (U32)	Access: RO	PDO map: Not possible	
Sub-index63: 63rd Input Object to be mapped			
Range: –	Unit: –	Default: 60053F20 hex	
Size: 4 bytes (U32)	Access: RO	PDO map: Not possible	
Sub-index64: 64th Input Object to be mapped			
Range: –	Unit: –	Default: 60054020 hex	
Size: 4 bytes (U32)	Access: RO	PDO map: Not possible	

- This object gives the mapping for an application that uses vision sensor functions.
- 6005 hex (Image Processing Results Integer Data)

1A08 hex	9th transmit PDO Mapping		
Sub-index0: Number of objects			
Range: –	Unit: –	Default: 4 hex	
Size: 1 byte (U8)	Access: RO	PDO map: Not possible	
Sub-index1: 1st Input Object to be mapped			
Range: –	Unit: –	Default: 60060140 hex	
Size: 4 bytes (U32)	Access: RO	PDO map: Not possible	
Sub-index2: 2nd Input Object to be mapped			
Range: –	Unit: –	Default: 60060240 hex	
Size: 4 bytes (U32)	Access: RO	PDO map: Not possible	
Sub-index3: 3rd Input Object to be mapped			
Range: –	Unit: –	Default: 60060340 hex	
Size: 4 bytes (U32)	Access: RO	PDO map: Not possible	
Sub-index4: 4th Input Object to be mapped			
Range: –	Unit: –	Default: 60060440 hex	
Size: 4 bytes (U32)	Access: RO	PDO map: Not possible	

- This object gives the mapping for an application that uses vision sensor functions.
- 6006 hex (Image Processing Results Real Data)

1A09 hex	10th transmit PDO Mapping		
Sub-index0: Number of objects			
Range: –	Unit: –	Default: 16 hex	
Size: 1 byte (U8)	Access: RO	PDO map: Not possible	
Sub-index1: 1st Input Object to be mapped			
Range: –	Unit: –	Default: 60060140 hex	
Size: 4 bytes (U32)	Access: RO	PDO map: Not possible	
Sub-index2: 2nd Input Object to be mapped			
Range: –	Unit: –	Default: 60060240 hex	
Size: 4 bytes (U32)	Access: RO	PDO map: Not possible	
Sub-index3: 3rd Input Object to be mapped			
Range: –	Unit: –	Default: 60060340 hex	
Size: 4 bytes (U32)	Access: RO	PDO map: Not possible	
Sub-index4: 4th Input Object to be mapped			
Range: –	Unit: –	Default: 60060440 hex	
Size: 4 bytes (U32)	Access: RO	PDO map: Not possible	
Sub-index5: 5th Input Object to be mapped			
Range: –	Unit: –	Default: 60060540 hex	
Size: 4 bytes (U32)	Access: RO	PDO map: Not possible	
Sub-index6: 6th Input Object to be mapped			
Range: –	Unit: –	Default: 60060640 hex	
Size: 4 bytes (U32)	Access: RO	PDO map: Not possible	
Sub-index7: 7th Input Object to be mapped			
Range: –	Unit: –	Default: 60060740 hex	
Size: 4 bytes (U32)	Access: RO	PDO map: Not possible	
Sub-index8: 8th Input Object to be mapped			
Range: –	Unit: –	Default: 60060840 hex	
Size: 4 bytes (U32)	Access: RO	PDO map: Not possible	

- This object gives the mapping for an application that uses vision sensor functions.
- 6006 hex (Image Processing Results Real Data)

1A0A hex	11th transmit PDO Mapping		
Sub-index0: Number of objects			
Range: –	Unit: –	Default: 32 hex	
Size: 1 byte (U8)	Access: RO	PDO map: Not possible	
Sub-index1: 1st Input Object to be mapped			
Range: –	Unit: –	Default: 60060140 hex	
Size: 4 bytes (U32)	Access: RO	PDO map: Not possible	
Sub-index2: 2nd Input Object to be mapped			
Range: –	Unit: –	Default: 60060240 hex	
Size: 4 bytes (U32)	Access: RO	PDO map: Not possible	
Sub-index3: 3rd Input Object to be mapped			
Range: –	Unit: –	Default: 60060340 hex	
Size: 4 bytes (U32)	Access: RO	PDO map: Not possible	
Sub-index4: 4th Input Object to be mapped			
Range: –	Unit: –	Default: 60060440 hex	
Size: 4 bytes (U32)	Access: RO	PDO map: Not possible	
Sub-index5: 5th Input Object to be mapped			
Range: –	Unit: –	Default: 60060540 hex	
Size: 4 bytes (U32)	Access: RO	PDO map: Not possible	
Sub-index6: 6th Input Object to be mapped			
Range: –	Unit: –	Default: 60060640 hex	
Size: 4 bytes (U32)	Access: RO	PDO map: Not possible	
Sub-index7: 7th Input Object to be mapped			
Range: –	Unit: –	Default: 60060740 hex	
Size: 4 bytes (U32)	Access: RO	PDO map: Not possible	
Sub-index8: 8th Input Object to be mapped			
Range: –	Unit: –	Default: 60060840 hex	
Size: 4 bytes (U32)	Access: RO	PDO map: Not possible	
Sub-index9: 9th Input Object to be mapped			
Range: –	Unit: –	Default: 60060940 hex	
Size: 4 bytes (U32)	Access: RO	PDO map: Not possible	
Sub-index10: 10th Input Object to be mapped			
Range: –	Unit: –	Default: 60060A40 hex	
Size: 4 bytes (U32)	Access: RO	PDO map: Not possible	
Sub-index11: 11th Input Object to be mapped			
Range: –	Unit: –	Default: 60060B40 hex	
Size: 4 bytes (U32)	Access: RO	PDO map: Not possible	
Sub-index12: 12th Input Object to be mapped			
Range: –	Unit: –	Default: 60060C40 hex	
Size: 4 bytes (U32)	Access: RO	PDO map: Not possible	
Sub-index13: 13th Input Object to be mapped			
Range: –	Unit: –	Default: 60060D40 hex	
Size: 4 bytes (U32)	Access: RO	PDO map: Not possible	

Sub-index14: 14th Input Object to be mapped			
Range: –	Unit: –	Default: 60060E40 hex	
Size: 4 bytes (U32)	Access: RO	PDO map: Not possible	
Sub-index15: 15th Input Object to be mapped			
Range: –	Unit: –	Default: 60060F40 hex	
Size: 4 bytes (U32)	Access: RO	PDO map: Not possible	
Sub-index16: 16th Input Object to be mapped			
Range: –	Unit: –	Default: 60061040 hex	
Size: 4 bytes (U32)	Access: RO	PDO map: Not possible	

- This object gives the mapping for an application that uses vision sensor functions.
- 6006 hex (Image Processing Results Real Data)

1A0B hex	12th transmit PDO Mapping		
Sub-index0: Number of objects			
Range: –	Unit: –	Default: 64 hex	
Size: 1 byte (U8)	Access: RO	PDO map: Not possible	
Sub-index1: 1st Input Object to be mapped			
Range: –	Unit: –	Default: 60060140 hex	
Size: 4 bytes (U32)	Access: RO	PDO map: Not possible	
Sub-index2: 2nd Input Object to be mapped			
Range: –	Unit: –	Default: 60060240 hex	
Size: 4 bytes (U32)	Access: RO	PDO map: Not possible	
Sub-index3: 3rd Input Object to be mapped			
Range: –	Unit: –	Default: 60060340 hex	
Size: 4 bytes (U32)	Access: RO	PDO map: Not possible	
Sub-index4: 4th Input Object to be mapped			
Range: –	Unit: –	Default: 60060440 hex	
Size: 4 bytes (U32)	Access: RO	PDO map: Not possible	
Sub-index5: 5th Input Object to be mapped			
Range: –	Unit: –	Default: 60060540 hex	
Size: 4 bytes (U32)	Access: RO	PDO map: Not possible	
Sub-index6: 6th Input Object to be mapped			
Range: –	Unit: –	Default: 60060640 hex	
Size: 4 bytes (U32)	Access: RO	PDO map: Not possible	
Sub-index7: 7th Input Object to be mapped			
Range: –	Unit: –	Default: 60060740 hex	
Size: 4 bytes (U32)	Access: RO	PDO map: Not possible	
Sub-index8: 8th Input Object to be mapped			
Range: –	Unit: –	Default: 60060840 hex	
Size: 4 bytes (U32)	Access: RO	PDO map: Not possible	
Sub-index9: 9th Input Object to be mapped			
Range: –	Unit: –	Default: 60060940 hex	
Size: 4 bytes (U32)	Access: RO	PDO map: Not possible	
Sub-index10: 10th Input Object to be mapped			
Range: –	Unit: –	Default: 60060A40 hex	
Size: 4 bytes (U32)	Access: RO	PDO map: Not possible	
Sub-index11: 11th Input Object to be mapped			
Range: –	Unit: –	Default: 60060B40 hex	
Size: 4 bytes (U32)	Access: RO	PDO map: Not possible	
Sub-index12: 12th Input Object to be mapped			
Range: –	Unit: –	Default: 60060C40 hex	
Size: 4 bytes (U32)	Access: RO	PDO map: Not possible	
Sub-index13: 13th Input Object to be mapped			
Range: –	Unit: –	Default: 60060D40 hex	
Size: 4 bytes (U32)	Access: RO	PDO map: Not possible	

Sub-index14: 14th Input Object to be mapped			
Range: –	Unit: –	Default: 60060E40 hex	
Size: 4 bytes (U32)	Access: RO	PDO map: Not possible	
Sub-index15: 15th Input Object to be mapped			
Range: –	Unit: –	Default: 60060F40 hex	
Size: 4 bytes (U32)	Access: RO	PDO map: Not possible	
Sub-index16: 16th Input Object to be mapped			
Range: –	Unit: –	Default: 60061040 hex	
Size: 4 bytes (U32)	Access: RO	PDO map: Not possible	
Sub-index17: 17th Input Object to be mapped			
Range: –	Unit: –	Default: 60061140 hex	
Size: 4 bytes (U32)	Access: RO	PDO map: Not possible	
Sub-index18: 18th Input Object to be mapped			
Range: –	Unit: –	Default: 60061240 hex	
Size: 4 bytes (U32)	Access: RO	PDO map: Not possible	
Sub-index19: 19th Input Object to be mapped			
Range: –	Unit: –	Default: 60061340 hex	
Size: 4 bytes (U32)	Access: RO	PDO map: Not possible	
Sub-index20: 20th Input Object to be mapped			
Range: –	Unit: –	Default: 60061440 hex	
Size: 4 bytes (U32)	Access: RO	PDO map: Not possible	
Sub-index21: 21st Input Object to be mapped			
Range: –	Unit: –	Default: 60061540 hex	
Size: 4 bytes (U32)	Access: RO	PDO map: Not possible	
Sub-index22: 22nd Input Object to be mapped			
Range: –	Unit: –	Default: 60061640 hex	
Size: 4 bytes (U32)	Access: RO	PDO map: Not possible	
Sub-index23: 23rd Input Object to be mapped			
Range: –	Unit: –	Default: 60061740 hex	
Size: 4 bytes (U32)	Access: RO	PDO map: Not possible	
Sub-index24: 24th Input Object to be mapped			
Range: –	Unit: –	Default: 60061840 hex	
Size: 4 bytes (U32)	Access: RO	PDO map: Not possible	
Sub-index25: 25th Input Object to be mapped			
Range: –	Unit: –	Default: 60061940 hex	
Size: 4 bytes (U32)	Access: RO	PDO map: Not possible	
Sub-index26: 26th Input Object to be mapped			
Range: –	Unit: –	Default: 60061A40 hex	
Size: 4 bytes (U32)	Access: RO	PDO map: Not possible	
Sub-index27: 27th Input Object to be mapped			
Range: –	Unit: –	Default: 60061B40 hex	
Size: 4 bytes (U32)	Access: RO	PDO map: Not possible	

Sub-index28: 28th Input Object to be mapped			
Range: –	Unit: –	Default: 60061C40 hex	
Size: 4 bytes (U32)	Access: RO	PDO map: Not possible	
Sub-index29: 29th Input Object to be mapped			
Range: –	Unit: –	Default: 60061D40 hex	
Size: 4 bytes (U32)	Access: RO	PDO map: Not possible	
Sub-index30: 30th Input Object to be mapped			
Range: –	Unit: –	Default: 60061E40 hex	
Size: 4 bytes (U32)	Access: RO	PDO map: Not possible	
Sub-index31: 31st Input Object to be mapped			
Range: –	Unit: –	Default: 60061F40 hex	
Size: 4 bytes (U32)	Access: RO	PDO map: Not possible	
Sub-index32: 32nd Input Object to be mapped			
Range: –	Unit: –	Default: 60062040 hex	
Size: 4 bytes (U32)	Access: RO	PDO map: Not possible	

- This object gives the mapping for an application that uses vision sensor functions.
- 6006 hex (Image Processing Results Real Data)

1A0C hex	13th transmit PDO Mapping		
Sub-index0: Number of objects			
Range: –	Unit: –	Default: 5 hex	
Size: 1 byte (U8)	Access: RO	PDO map: Not possible	
Sub-index1: 1st Input Object to be mapped			
Range: –	Unit: –	Default: 60050120 hex	
Size: 4 bytes (U32)	Access: RO	PDO map: Not possible	
Sub-index2: 2nd Input Object to be mapped			
Range: –	Unit: –	Default: 60050220 hex	
Size: 4 bytes (U32)	Access: RO	PDO map: Not possible	
Sub-index3: 3rd Input Object to be mapped			
Range: –	Unit: –	Default: 60060140 hex	
Size: 4 bytes (U32)	Access: RO	PDO map: Not possible	
Sub-index4: 4th Input Object to be mapped			
Range: –	Unit: –	Default: 60060240 hex	
Size: 4 bytes (U32)	Access: RO	PDO map: Not possible	
Sub-index5: 5th Input Object to be mapped			
Range: –	Unit: –	Default: 60060340 hex	
Size: 4 bytes (U32)	Access: RO	PDO map: Not possible	

- This object gives the mapping for an application that uses vision sensor functions.
- 6005 hex (Image Processing Results Integer Data)
- 6006 hex (Image Processing Results Real Data)

1A0D hex	14th transmit PDO Mapping		
Sub-index0: Number of objects			
Range: –	Unit: –	Default: 10 hex	
Size: 1 byte (U8)	Access: RO	PDO map: Not possible	
Sub-index1: 1st Input Object to be mapped			
Range: –	Unit: –	Default: 60050120 hex	
Size: 4 bytes (U32)	Access: RO	PDO map: Not possible	
Sub-index2: 2nd Input Object to be mapped			
Range: –	Unit: –	Default: 60050220 hex	
Size: 4 bytes (U32)	Access: RO	PDO map: Not possible	
Sub-index3: 3rd Input Object to be mapped			
Range: –	Unit: –	Default: 60050320 hex	
Size: 4 bytes (U32)	Access: RO	PDO map: Not possible	
Sub-index4: 4th Input Object to be mapped			
Range: –	Unit: –	Default: 60050420 hex	
Size: 4 bytes (U32)	Access: RO	PDO map: Not possible	
Sub-index5: 5th Input Object to be mapped			
Range: –	Unit: –	Default: 60060140 hex	
Size: 4 bytes (U32)	Access: RO	PDO map: Not possible	
Sub-index6: 6th Input Object to be mapped			
Range: –	Unit: –	Default: 60060240 hex	
Size: 4 bytes (U32)	Access: RO	PDO map: Not possible	
Sub-index7: 7th Input Object to be mapped			
Range: –	Unit: –	Default: 60060340 hex	
Size: 4 bytes (U32)	Access: RO	PDO map: Not possible	
Sub-index8: 8th Input Object to be mapped			
Range: –	Unit: –	Default: 60060440 hex	
Size: 4 bytes (U32)	Access: RO	PDO map: Not possible	
Sub-index9: 9th Input Object to be mapped			
Range: –	Unit: –	Default: 60060540 hex	
Size: 4 bytes (U32)	Access: RO	PDO map: Not possible	
Sub-index10: 10th Input Object to be mapped			
Range: –	Unit: –	Default: 60060640 hex	
Size: 4 bytes (U32)	Access: RO	PDO map: Not possible	

- This object gives the mapping for an application that uses vision sensor functions.
- 6005 hex (Image Processing Results Integer Data)
- 6006 hex (Image Processing Results Real Data)

1A0E hex		15th transmit PDO Mapping	
Sub-index0: Number of objects			
Range: –	Unit: –	Default: 20 hex	
Size: 1 byte (U8)	Access: RO	PDO map: Not possible	
Sub-index1: 1st Input Object to be mapped			
Range: –	Unit: –	Default: 60050120 hex	
Size: 4 bytes (U32)	Access: RO	PDO map: Not possible	
Sub-index2: 2nd Input Object to be mapped			
Range: –	Unit: –	Default: 60050220 hex	
Size: 4 bytes (U32)	Access: RO	PDO map: Not possible	
Sub-index3: 3rd Input Object to be mapped			
Range: –	Unit: –	Default: 60050320 hex	
Size: 4 bytes (U32)	Access: RO	PDO map: Not possible	
Sub-index4: 4th Input Object to be mapped			
Range: –	Unit: –	Default: 60050420 hex	
Size: 4 bytes (U32)	Access: RO	PDO map: Not possible	
Sub-index5: 5th Input Object to be mapped			
Range: –	Unit: –	Default: 60050520 hex	
Size: 4 bytes (U32)	Access: RO	PDO map: Not possible	
Sub-index6: 6th Input Object to be mapped			
Range: –	Unit: –	Default: 60050620 hex	
Size: 4 bytes (U32)	Access: RO	PDO map: Not possible	
Sub-index7: 7th Input Object to be mapped			
Range: –	Unit: –	Default: 60050720 hex	
Size: 4 bytes (U32)	Access: RO	PDO map: Not possible	
Sub-index8: 8th Input Object to be mapped			
Range: –	Unit: –	Default: 60050820 hex	
Size: 4 bytes (U32)	Access: RO	PDO map: Not possible	
Sub-index9: 9th Input Object to be mapped			
Range: –	Unit: –	Default: 60060410 hex	
Size: 4 bytes (U32)	Access: RO	PDO map: Not possible	
Sub-index10: 10th Input Object to be mapped			
Range: –	Unit: –	Default: 60060420 hex	
Size: 4 bytes (U32)	Access: RO	PDO map: Not possible	
Sub-index11: 11th Input Object to be mapped			
Range: –	Unit: –	Default: 60060430 hex	
Size: 4 bytes (U32)	Access: RO	PDO map: Not possible	
Sub-index12: 12th Input Object to be mapped			
Range: –	Unit: –	Default: 60060440 hex	
Size: 4 bytes (U32)	Access: RO	PDO map: Not possible	
Sub-index13: 13th Input Object to be mapped			
Range: –	Unit: –	Default: 60060450 hex	
Size: 4 bytes (U32)	Access: RO	PDO map: Not possible	

Sub-index14: 14th Input Object to be mapped			
Range: –	Unit: –	Default: 60060460 hex	
Size: 4 bytes (U32)	Access: RO	PDO map: Not possible	
Sub-index15: 15th Input Object to be mapped			
Range: –	Unit: –	Default: 60060470 hex	
Size: 4 bytes (U32)	Access: RO	PDO map: Not possible	
Sub-index16: 16th Input Object to be mapped			
Range: –	Unit: –	Default: 60060480 hex	
Size: 4 bytes (U32)	Access: RO	PDO map: Not possible	
Sub-index17: 17th Input Object to be mapped			
Range: –	Unit: –	Default: 60060490 hex	
Size: 4 bytes (U32)	Access: RO	PDO map: Not possible	
Sub-index18: 18th Input Object to be mapped			
Range: –	Unit: –	Default: 600604A0 hex	
Size: 4 bytes (U32)	Access: RO	PDO map: Not possible	
Sub-index19: 19th Input Object to be mapped			
Range: –	Unit: –	Default: 600604B0 hex	
Size: 4 bytes (U32)	Access: RO	PDO map: Not possible	
Sub-index20: 20th Input Object to be mapped			
Range: –	Unit: –	Default: 600604C0 hex	
Size: 4 bytes (U32)	Access: RO	PDO map: Not possible	

- This object gives the mapping for an application that uses vision sensor functions.
- 6005 hex (Image Processing Results Integer Data)
- 6006 hex (Image Processing Results Real Data)

1A0F hex		16th transmit PDO Mapping	
Sub-index0: Number of objects			
Range: –	Unit: –	Default: 40 hex	
Size: 1 byte (U8)	Access: RO	PDO map: Not possible	
Sub-index1: 1st Input Object to be mapped			
Range: –	Unit: –	Default: 60050120 hex	
Size: 4 bytes (U32)	Access: RO	PDO map: Not possible	
Sub-index2: 2nd Input Object to be mapped			
Range: –	Unit: –	Default: 60050220 hex	
Size: 4 bytes (U32)	Access: RO	PDO map: Not possible	
Sub-index3: 3rd Input Object to be mapped			
Range: –	Unit: –	Default: 60050320 hex	
Size: 4 bytes (U32)	Access: RO	PDO map: Not possible	
Sub-index4: 4th Input Object to be mapped			
Range: –	Unit: –	Default: 60050420 hex	
Size: 4 bytes (U32)	Access: RO	PDO map: Not possible	
Sub-index5: 5th Input Object to be mapped			
Range: –	Unit: –	Default: 60050520 hex	
Size: 4 bytes (U32)	Access: RO	PDO map: Not possible	
Sub-index6: 6th Input Object to be mapped			
Range: –	Unit: –	Default: 60050620 hex	
Size: 4 bytes (U32)	Access: RO	PDO map: Not possible	
Sub-index7: 7th Input Object to be mapped			
Range: –	Unit: –	Default: 60050720 hex	
Size: 4 bytes (U32)	Access: RO	PDO map: Not possible	
Sub-index8: 8th Input Object to be mapped			
Range: –	Unit: –	Default: 60050820 hex	
Size: 4 bytes (U32)	Access: RO	PDO map: Not possible	
Sub-index9: 9th Input Object to be mapped			
Range: –	Unit: –	Default: 60050920 hex	
Size: 4 bytes (U32)	Access: RO	PDO map: Not possible	
Sub-index10: 10th Input Object to be mapped			
Range: –	Unit: –	Default: 60050A20 hex	
Size: 4 bytes (U32)	Access: RO	PDO map: Not possible	
Sub-index11: 11th Input Object to be mapped			
Range: –	Unit: –	Default: 60050B20 hex	
Size: 4 bytes (U32)	Access: RO	PDO map: Not possible	
Sub-index12: 12th Input Object to be mapped			
Range: –	Unit: –	Default: 60050C20 hex	
Size: 4 bytes (U32)	Access: RO	PDO map: Not possible	
Sub-index13: 13th Input Object to be mapped			
Range: –	Unit: –	Default: 60050D20 hex	
Size: 4 bytes (U32)	Access: RO	PDO map: Not possible	

Sub-index14: 14th Input Object to be mapped			
Range: –	Unit: –	Default: 60050E20 hex	
Size: 4 bytes (U32)	Access: RO	PDO map: Not possible	
Sub-index15: 15th Input Object to be mapped			
Range: –	Unit: –	Default: 60050F20 hex	
Size: 4 bytes (U32)	Access: RO	PDO map: Not possible	
Sub-index16: 16th Input Object to be mapped			
Range: –	Unit: –	Default: 60051020 hex	
Size: 4 bytes (U32)	Access: RO	PDO map: Not possible	
Sub-index17: 17th Input Object to be mapped			
Range: –	Unit: –	Default: 60060140 hex	
Size: 4 bytes (U32)	Access: RO	PDO map: Not possible	
Sub-index18: 18th Input Object to be mapped			
Range: –	Unit: –	Default: 60060240 hex	
Size: 4 bytes (U32)	Access: RO	PDO map: Not possible	
Sub-index19: 19th Input Object to be mapped			
Range: –	Unit: –	Default: 60060340 hex	
Size: 4 bytes (U32)	Access: RO	PDO map: Not possible	
Sub-index20: 20th Input Object to be mapped			
Range: –	Unit: –	Default: 60060440 hex	
Size: 4 bytes (U32)	Access: RO	PDO map: Not possible	
Sub-index21: 21st Input Object to be mapped			
Range: –	Unit: –	Default: 60060540 hex	
Size: 4 bytes (U32)	Access: RO	PDO map: Not possible	
Sub-index22: 22nd Input Object to be mapped			
Range: –	Unit: –	Default: 60060640 hex	
Size: 4 bytes (U32)	Access: RO	PDO map: Not possible	
Sub-index23: 23rd Input Object to be mapped			
Range: –	Unit: –	Default: 60060740 hex	
Size: 4 bytes (U32)	Access: RO	PDO map: Not possible	
Sub-index24: 24th Input Object to be mapped			
Range: –	Unit: –	Default: 60060840 hex	
Size: 4 bytes (U32)	Access: RO	PDO map: Not possible	
Sub-index25: 25th Input Object to be mapped			
Range: –	Unit: –	Default: 60060940 hex	
Size: 4 bytes (U32)	Access: RO	PDO map: Not possible	
Sub-index26: 26th Input Object to be mapped			
Range: –	Unit: –	Default: 60060A40 hex	
Size: 4 bytes (U32)	Access: RO	PDO map: Not possible	
Sub-index27: 27th Input Object to be mapped			
Range: –	Unit: –	Default: 60060B40 hex	
Size: 4 bytes (U32)	Access: RO	PDO map: Not possible	

Sub-index28: 28th Input Object to be mapped			
Range: –	Unit: –	Default: 60060C40 hex	
Size: 4 bytes (U32)	Access: RO	PDO map: Not possible	
Sub-index29: 29th Input Object to be mapped			
Range: –	Unit: –	Default: 60060D40 hex	
Size: 4 bytes (U32)	Access: RO	PDO map: Not possible	
Sub-index30: 30th Input Object to be mapped			
Range: –	Unit: –	Default: 60060E40 hex	
Size: 4 bytes (U32)	Access: RO	PDO map: Not possible	
Sub-index31: 31st Input Object to be mapped			
Range: –	Unit: –	Default: 60060F40 hex	
Size: 4 bytes (U32)	Access: RO	PDO map: Not possible	
Sub-index32: 32nd Input Object to be mapped			
Range: –	Unit: –	Default: 60061040 hex	
Size: 4 bytes (U32)	Access: RO	PDO map: Not possible	
Sub-index33: 33rd Input Object to be mapped			
Range: –	Unit: –	Default: 60061140 hex	
Size: 4 bytes (U32)	Access: RO	PDO map: Not possible	
Sub-index34: 34th Input Object to be mapped			
Range: –	Unit: –	Default: 60061240 hex	
Size: 4 bytes (U32)	Access: RO	PDO map: Not possible	
Sub-index35: 35th Input Object to be mapped			
Range: –	Unit: –	Default: 60061340 hex	
Size: 4 bytes (U32)	Access: RO	PDO map: Not possible	
Sub-index36: 36th Input Object to be mapped			
Range: –	Unit: –	Default: 60061440 hex	
Size: 4 bytes (U32)	Access: RO	PDO map: Not possible	
Sub-index37: 37th Input Object to be mapped			
Range: –	Unit: –	Default: 60061540 hex	
Size: 4 bytes (U32)	Access: RO	PDO map: Not possible	
Sub-index38: 38th Input Object to be mapped			
Range: –	Unit: –	Default: 60061640 hex	
Size: 4 bytes (U32)	Access: RO	PDO map: Not possible	
Sub-index39: 39th Input Object to be mapped			
Range: –	Unit: –	Default: 60061740 hex	
Size: 4 bytes (U32)	Access: RO	PDO map: Not possible	
Sub-index40: 40th Input Object to be mapped			
Range: –	Unit: –	Default: 60061840 hex	
Size: 4 bytes (U32)	Access: RO	PDO map: Not possible	

- This object gives the mapping for an application that uses vision sensor functions.
- 6005 hex (Image Processing Results Integer Data)
- 6006 hex (Image Processing Results Real Data)

Objects are provided for each line as shown below when more than one line is used.

Line 1:1A20 hex (1st transmit PDO mapping) and 1A21 to 1A2F hex (2nd to 16th transmit PDO mapping)

Line 2:1A40 hex (1st transmit PDO mapping) and 1A41 to 1A4F hex (2nd to 16th transmit PDO mapping)

Line 3:1A60 hex (1st transmit PDO mapping) and 1A61 to 1A6F hex (2nd to 16th transmit PDO mapping)

Line 4:1A80 hex (1st transmit PDO mapping) and 1A81 to 1A8F hex (2nd to 16th transmit PDO mapping)

Line 5:1AA0 hex (1st transmit PDO mapping) and 1AA1 to 1AAF hex (2nd to 16th transmit PDO mapping)

Line 6:1AC0 hex (1st transmit PDO mapping) and 1AC1 to 1ACF hex (2nd to 16th transmit PDO mapping)

Line 7:1AE0 hex (1st transmit PDO mapping) and 1AE1 to 1AEF hex (2nd to 16th transmit PDO mapping)

1A10 hex	17th transmit PDO Mapping		
Sub-index0: Number of objects			
Range: –	Unit: –	Default: 06 hex	
Size: 1 byte (U8)	Access: RO	PDO map: Not possible	
Sub-index1: 1st Input Object to be mapped			
Range: –	Unit: –	Default: 60070120 hex	
Size: 4 bytes (U32)	Access: RO	PDO map: Not possible	
Sub-index2: 2nd Input Object to be mapped			
Range: –	Unit: –	Default: 60070220 hex	
Size: 4 bytes (U32)	Access: RO	PDO map: Not possible	
Sub-index3: 3rd Input Object to be mapped			
Range: –	Unit: –	Default: 60070320 hex	
Size: 4 bytes (U32)	Access: RO	PDO map: Not possible	
Sub-index4: 4th Input Object to be mapped			
Range: –	Unit: –	Default: 60070420 hex	
Size: 4 bytes (U32)	Access: RO	PDO map: Not possible	
Sub-index5: 5th Input Object to be mapped			
Range: –	Unit: –	Default: 60070540 hex	
Size: 4 bytes (U32)	Access: RO	PDO map: Not possible	
Sub index6: PDO entry 6 (6th Input Object to be mapped)			
Setting range: -	Unit: -	Default: 60070640Hex	
Size: 4byte (U32)	Access: RO	PDO Map: Not possible	

- This object gives the mapping for an application that uses vision sensor functions.
- 6005Hex (Integer data of image processing result)
- 6006Hex (Real data of image processing result)
- 6007Hex (User output area)

Objects are provided for each line as shown below when more than one line is used.

Line1: 1A20Hex (1st transmit PDO Mapping), 1A21Hex to 1A30Hex (2nd to17th transmit PDO Mapping)

Line2: 1A40Hex (1st transmit PDO Mapping), 1A41Hex to 1A50Hex (2nd to17th transmit PDO Mapping)

Line3: 1A60Hex (1st transmit PDO Mapping), 1A61Hex to 1A70Hex (2nd to17th transmit PDO Mapping)

Line4: 1A80Hex (1st transmit PDO Mapping), 1A81Hex to 1A90Hex (2nd to17th transmit PDO Mapping)

Line5: 1AA0Hex (1st transmit PDO Mapping), 1AA1Hex to 1AB0Hex (2nd to17th transmit PDO Mapping)

Line6: 1AC0Hex (1st transmit PDO Mapping), 1AC1Hex to 1AD0Hex (2nd to17th transmit PDO Mapping)

Line7: 1AE0Hex (1st transmit PDO Mapping), 1AE1Hex to 1AF0Hex (2nd to17th transmit PDO Mapping)

1BFFh	512th transmit PDO Mapping		
Sub-index0: Number of objects in this PDO			
Range: –	Unit: –	Default: 01 hex	Attribute: –
Size: 1 byte (U8)	Access: RO	PDO map: Not possible	
Sub-index1: 1st Input Object to be mapped			
Range: –	Unit: –	Default: 20020108 hex	Attribute: –
Size: 4 bytes (U32)	Access: RO	PDO map: Not possible	

- This object gives the mapping for notification of errors that are detected in the Slave Unit.
- The mapping includes 2002 hex-01 hex (Sysmac Error Status).
- When connected to an NJ-series Machine Automation Controller, 1C13 hex (Sync manager 3 PDO assignment) is assigned to this object.
- This object is automatically assigned in the default settings of the Sysmac Studio.

Sync Manager Communication Object

The communication memory of EtherCAT is set by the objects from 1C00 hex to 1C13 hex.

1C00 hex	Sync Manager Communication Type		
Sub-index 0: Number of used SM channels			
Range: –	Unit: –	Default: 04 hex	Attribute: –
Size: 1 byte (U8)	Access: RO	PDO map: Not possible	
Sub-index 1: Communication Type Sync Manager 0			
Range: –	Unit: –	Default: 01 hex	Attribute: –
Size: 4 bytes (U8)	Access: RO	PDO map: Not possible	
Sub-index 2: Communication Type Sync Manager 1			
Range: –	Unit: –	Default: 02 hex	Attribute: –
Size: 4 bytes (U8)	Access: RO	PDO map: Not possible	
Sub-index 3: Communication Type Sync Manager 2			
Range: –	Unit: –	Default: 03 hex	Attribute: –
Size: 4 bytes (U8)	Access: RO	PDO map: Not possible	
Sub-index 4: Communication Type Sync Manager 3			
Range: –	Unit: –	Default: 04 hex	Attribute: –
Size: 4 bytes (U8)	Access: RO	PDO map: Not possible	

- The sync manager has the following settings.
 - SM0: Mailbox receive (EtherCAT Master Unit to Slave Unit)
 - SM1: Mailbox transmit (EtherCAT Slave Unit to Master Unit)
 - SM2: Process data output (EtherCAT Master Unit to Slave Unit)
 - SM3: Process data input (EtherCAT Slave Unit to Master Unit)

1C10 hex	Sync Manager 0 PDO Assignment		
Sub-index 0: Number of assigned PDOs			
Range: 00 hex	Unit: –	Default: 00 hex	Attribute: –
Size: 1 byte (U8)	Access: RO	PDO map: Not possible	

- It indicates the number of PDO mappings used by this sync manager.
- Mailbox reception sync manager does not have PDOs.

1C11 hex	Sync Manager 1 PDO Assignment		
Sub-index 0: Number of assigned PDOs			
Range: 00 hex	Unit: –	Default: 00 hex	Attribute: –
Size: 1 byte (U8)	Access: RO	PDO map: Not possible	

- It indicates the number of PDO mappings used by this sync manager.
- Mailbox transmit sync manager does not have PDOs.

1C12 hex	Sync Manager 2 PDO Assignment		
Sub-index 0: Number of assigned PDOs			
Range: –	Unit: –	Default: 02 hex	Attribute: –
Size: 1 byte (U8)	Access: RW ^{*1}	PDO map: Not possible	
Sub-index 1-2: 1st-2nd PDO Mapping Object Index of assigned 2nd PDO			
Range: –	Unit: –	Default: Differ by Slave Unit types	Attribute: –
Size: 2 bytes (U16)	Access: RW ^{*1}	PDO map: Not possible	

*1: If a receive PDO is not provided, R0 is used.

- It indicates the RxPDOs used by this sync manager.

1C13 hex	Sync Manager 3 PDO Assignment		
Sub-index 0: Number of assigned PDOs			
Range: –	Unit: –	Default: 05 hex	Attribute: –
Size: 1 byte (U8)	Access: RW ^{*1}	PDO map: Not possible	
Sub-index 1-5: 1st-5th PDO Mapping Object Index of assigned PDO			
Range: –	Unit: –	Default: Differ by Slave Unit types	Attribute: –
Size: 2 bytes (U16)	Access: RW ^{*1}	PDO map: Not possible	

*1: "RO" is set if there is no TxPDO.

- It indicates the TxPDOs used by this sync manager.

Manufacturer Specific Objects

This section explains the CiA401 generic I/O module device profile implemented in FH-series EtherCAT Slave Units and the objects specially mounted in FH-series EtherCAT Slave Units.

Common Objects for Sysmac Devices

Manufacturer Specific area 1

2100 hex	Error History Clear		
Range: –	Unit: –	Default: 00000000 hex	Attribute: A
Size: 4 bytes (U32)	Access: RW	PDO map: Not possible	

- This object clears diagnosis history of 10F3 hex (Diagnosis History).
- It clears the history only when specific values are written. The specific value is "elcl".

MSB

LSB

l	c	l	e
6C hex	63 hex	6C hex	65 hex

Writing values other than this is invalid.

2002 hex	Sysmac Error		
Sub-index 0: Number of entries			
Range: –	Unit: –	Default: 02 hex	Attribute: –
Size: 1 byte (U8)	Access: RO	PDO map: Not possible	
Sub-index 1: Sysmac Error Status			
Range: –	Unit: –	Default: 00 hex	Attribute: –
Size: 1 byte (U8)	Access: RO	PDO map: Not possible	
Sub-index 2: Sysmac Error Status Clear			
Range: –	Unit: –	Default: 00 hex	Attribute: A
Size: 1 byte (U8)	Access: RW	PDO map: Not possible	

- The mapping is used for Sysmac error status notification and to clear Sysmac error status.
- Sub-index 1: Sysmac Error Status
 - This object is for notification of errors that are detected in the Slave Unit.
 - When connected to an NJ-series Machine Automation Controller, map this object to a PDO.
- Sub-index 2: Sysmac Error Status Clear
 - This object is used by the Controller (a Sysmac device) to reset errors that occur in Slave Units.

Note

In the default Sysmac Studio settings, sub-index 1 (Sysmac Error Status) is automatically mapped to a PDO because 1BFF hex (512th transmit PDO Mapping) is assigned.

2200 hex	Communication Error Setting		
Range: 00 hex to 0F hex	Unit: number of sequences	Default: 01 hex	Attribute: C
Size: 1 byte (U8)	Access: RW	PDO map: Not possible	

- Object mounted only on Slave Units operating in the DC mode.
- The number of sequences for detecting communications errors is set with this object.
- The setting range is from 00 to 0F hex and the number of detections is "the set number of times + 1."
- Rewriting value is possible at operation in the DC mode, but the operation is performed with the value set when shifting from the pre-operational state to safe-operational state. Note that at this point, the rewritten value is read.

Note

With the default setting of 01 hex, an error is detected if communications errors occur twice in a row.

2201 hex	Sync Not Received Timeout Setting		
Range: 0000 hex to 0258 hex	Unit: s	Default: 0000 hex	Attribute: C
Size: 2 bytes (U16)	Access: RW	PDO map: Not possible	

- Object mounted only on Slave Units operating in the DC mode.
- This object is used to set the standby time until the first synchronization interrupt signal (SYNC0) is input after shifting to the safe-operational state (state where a DC mode is confirmed).
- If the first interrupt signal (SYNC0) is not input at all within this setting time, a synchronization error occurs.
- The setting range is from 0000 hex to 0258 hex (600s) and operation is performed at 120s when 0000 hex is set.
- Rewriting value is possible at operation in the DC mode, but the operation is performed with the value set when shifting from the pre-operational state to safe-operational state. Note that at this point, the rewritten value is read.

Vision Sensor Specific Objects

Manufacturer Specific area 2

6000 hex	Status Flag		
Sub-index0: Number of entries			
Range: –	Unit: –	Default: 00 hex	
Size: 1 byte (U8)	Access: RO	PDO map: Not possible	
Sub-index1: Command Completion Bit			
Range: True (1) or False (0)	Unit: –	Default: False (0)	
Size: 1 bit (BOOL)	Access: RO	PDO map: Possible	
Sub-index2: BUSY Bit			
Range: True (1) or False (0)	Unit: –	Default: Differ by the status when starting	
Size: 1 bit (BOOL)	Access: RO	PDO map: Possible	
Sub-index3: Trigger Ready Bit			
Range: True (1) or False (0)	Unit: –	Default: Differ by the status when starting	
Size: 1 bit (BOOL)	Access: RO	PDO map: Possible	
Sub-index4: Total Judgment Bit			
Range: True (1) or False (0)	Unit: –	Default: False (0)	
Size: 1 bit (BOOL)	Access: RO	PDO map: Possible	
Sub-index5: RUN Mode Bit			
Range: True (1) or False (0)	Unit: –	Default: Differ by the status when starting	
Size: 1 bit (BOOL)	Access: RO	PDO map: Possible	
Sub-index6: Trigger Ack Bit			
Range: True (1) or False (0)	Unit: –	Default: Differ by the status when starting	
Size: 1 bit (BOOL)	Access: RO	PDO map: Possible	
Sub-index7: Command Ready Bit			
Range: True (1) or False (0)	Unit: –	Default: Differ by the status when starting	
Size: 1 bit (BOOL)	Access: RO	PDO map: Possible	
Sub-index8: Shutter Output Bit			
Range: True (1) or False (0)	Unit: –	Default: Differ by the status when starting	
Size: 1 bit (BOOL)	Access: RO	PDO map: Possible	

Sub-index9: Flow Command Completion Bit		
Range: True (1) or False (0)	Unit: –	Default: Differ by the status when starting
Size: 1 bit (BOOL)	Access: RO	PDO map: Possible
Sub-index10: Flow Command Busy Bit		
Range: True (1) or False (0)	Unit: –	Default: Differ by the status when starting
Size: 1 bit (BOOL)	Access: RO	PDO map: Possible
Sub-index11: Flow Command Wait Bit		
Range: True (1) or False (0)	Unit: –	Default: Differ by the status when starting
Size: 1 bit (BOOL)	Access: RO	PDO map: Possible
Sub-index12-15: Control Reserve Bit12-15		
Range: True (1) or False (0)	Unit: –	Default: False (0)
Size: 1 bit (BOOL)	Access: RO	PDO map: Possible
Sub-index16: Error Status Bit		
Range: True (1) or False (0)	Unit: –	Default: Differ by the status when starting
Size: 1 bit (BOOL)	Access: RO	PDO map: Possible
Sub-index17: Result Notification Bit		
Range: True (1) or False (0)	Unit: –	Default: False (0)
Size: 1 bit (BOOL)	Access: RO	PDO map: Possible
Sub-index18-32: Control Reserve Bit18-32		
Range: True (1) or False (0)	Unit: –	Default: False (0)
Size: 1 bit (BOOL)	Access: RO	PDO map: Possible

- This object gets the status of the Sensor Controller.
- Command Completion bit: ON during command execution.
- BUSY bit: ON during command or measurement execution.
- Trigger Ready bit: ON when Trigger signal can be input.
- Overall Judgement bit: ON when the overall judgement is NG.
- This mode will be [ON] when FH Sensor Controller is in Run Mode; Sensor Controller is in the measurable status and [RUN signal output] in Layout setup is checked.
- Trigger Ack bit: ON when the Vision Sensor acknowledges a Trigger signal.
- Command Ready bit: ON when a control command can be executed.
- Shutter Output bit: ON when the sensing elements have completed exposure.
- Flow Command Completion bit: ON when execution of a command that was executed during execution of PLC Link, fieldbus, normal flow control has been completed.
- Flow Command Busy bit: ON during execution of a command that was executed during execution of PLC Link, fieldbus, normal flow control.
- Flow Command Wait bit: ON while waiting for command input during execution of PLC Link, fieldbus, normal flow control.
- Error Status bit: ON when the Vision Sensor has detected an error.
- Result Notification bit: ON when the Vision Sensor completes data output.
- When you use the Sysmac Studio, all of the subindices of 1 that include the above bits are mapped.

6001 hex	Command Code Echo Back	
Range: –	Unit: –	Default: 00000000 hex
Size: 4 bytes (U32)	Access: RO	PDO map: Possible

- The executed command code is stored.

6002 hex	Response Data		
Range: –	Unit: –	Default: 00000000 hex	
Size: 4 bytes (U32)	Access: RO	PDO map: Possible	

- The response code is stored when the command is completed. (OK: 00000000 hex, NG: FFFFFFFF hex)

6003 hex	Response Data		
Sub-index0: Number of entries			
Range: –	Unit: –	Default: 01 hex	
Size: 1 byte (U8)	Access: RO	PDO map: Not possible	
Sub-index 1: Response Data0			
Range: –	Unit: –	Default: 00000000 hex	
Size: 4 bytes (INT32)	Access: RO	PDO map: Possible	

- The response data is stored the command is completed. (e.g. the scene number is stored when the command "Get scene number".)

6004 hex	Error Code		
Range: –	Unit: –	Default: 00000000 hex	
Size: 4 bytes (U32)	Access: RO	PDO map: Possible	

6005 hex	DINT Result Data		
Sub-index0: Number of entries			
Range: –	Unit: –	Default: 00 hex	
Size: 1 byte (U8)	Access: RO	PDO map: Not possible	
Sub-index0-63: DINT Result Data1-64			
Range: –	Unit: –	Default: 00000000 hex	
Size: 4 bytes (INT32)	Access: RO	PDO map: Possible	

- The output data are stored.

6006 hex	LREAL Result Data		
Sub-index0: Number of entries			
Range: –	Unit: –	Default: 00 hex	
Size: 1 byte (U8)	Access: RO	PDO map: Not possible	
Sub-index0-31: LREAL Result Data1-32			
Range: –	Unit: –	Default: 00000000 hex	
Size: 8 bytes (Double)	Access: RO	PDO map: Possible	

- The output data are stored.

6007Hex	User Output Area	
Sub-index 0: Number of entries		
Setting range: -	Unit: -	Default: 00Hex
Size: 1byte (U8)	Access: RO	PDO map: Not possible
Sub-index 1: User Output Area0 (User Output Area 0)		
Setting range: -	Unit: -	Default: 00000000Hex
Size: 4bytes (INT32)	Access: RO	PDO map: Possible
Sub-index 2: User Output Area1 (User Output Area 1)		
Setting range: -	Unit: -	Default: 00000000Hex
Size: 4bytes (INT32)	Access: RO	PDO map: Possible
Sub-index 3: User Output Area 2 (User Output Area 2)		
Setting range: -	Unit: -	Default: 00000000Hex
Size: 4bytes (INT32)	Access: RO	PDO map: Possible
Sub-index 4: User Output Area 3 (User Output Area 3)		
Setting range: -	Unit: -	Default: 00000000Hex
Size: 4bytes (INT32)	Access: RO	PDO map: Possible
Sub-index 5: User Output Area 4 (User Output Area 4)		
Setting range: -	Unit: -	Default: 00000000Hex
Size: 8bytes (Double)	Access: RO	PDO map: Possible
Sub-index 6: User Output Area 5 (User Output Area 5)		
Setting range: -	Unit: -	Default: 00000000Hex
Size: 8bytes (Double)	Access: RO	PDO map: Possible

- User Output Area is stored.

7000 hex	Control Flag		
Sub-index 0: Number of entries			
Range: –	Unit: –	Default: 00 hex	
Size: 1 byte (U8)	Access: RO	PDO map: Not possible	
Sub-index 1: Command Request			
Range: True (1) or False (0)	Unit: –	Default: False (0)	
Size: 1 bit (BOOL)	Access: RW	PDO map: Possible	
Sub-index 2: Trigger			
Range: True (1) or False (0)	Unit: –	Default: False (0)	
Size: 1 bit (BOOL)	Access: RW	PDO map: Possible	
Sub-index 3-8: Control Reserve Bit03-08			
Range: True (1) or False (0)	Unit: –	Default: False (0)	
Size: 1 bit (BOOL)	Access: RW	PDO map: Possible	
Sub-index 9: Flow Command Request			
Range: True (1) or False (0)	Unit: –	Default: False (0)	
Size: 1 bit (BOOL)	Access: RW	PDO map: Possible	
Sub-index 10-15: Control Reserve Bit10-15			
Range: True (1) or False (0)	Unit: –	Default: False (0)	
Size: 1 bit (BOOL)	Access: RW	PDO map: Possible	
Sub-index 16: Error Clear			
Range: True (1) or False (0)	Unit: –	Default: False (0)	
Size: 1 bit (BOOL)	Access: RW	PDO map: Possible	
Sub-index 17: Result Set Request			
Range: True (1) or False (0)	Unit: –	Default: False (0)	
Size: 1 bit (BOOL)	Access: RW	PDO map: Possible	
Sub-index 18-32: Control Reserve Bit18-32			
Range: True (1) or False (0)	Unit: –	Default: False (0)	
Size: 1 bit (BOOL)	Access: RW	PDO map: Possible	

- This object controls the Sensor Controller.
- Command Request bit: Turned ON to execute a command.
- Trigger bit: Turned ON to execute a measurement.
- Flow Command Request bit: Turned ON to execute a command during execution of PLC Link, fieldbus, normal flow control.
- Error Clear bit: Turned ON to clear the Error Status bit (3001 hex, subindex 17).
- Result Set Request bit: Turned ON to request data output.
- When you use the Sysmac Studio, all of the subindices of 1 that include the above bits are mapped.

7001 hex	Command Code		
Range: –	Unit: –	Default: 00000000 hex	
Size: 4 bytes (U32)	Access: RW	PDO map: Possible	

- Stores the command code such as "Change scene".

7002 hex	Command Parameter		
Sub-index0: Number of entries			
Range: -	Unit: -	Default: 00 hex	
Size: 1 byte (U8)	Access: RO	PDO map: Not possible	
Sub-index1: Command Parameter 0			
Range: -	Unit: -	Default: 00000000 hex	
Size: 4 bytes (4 bytes (INT32))	Access: RW	PDO map: Possible	
Sub-index2: Command Parameter 1			
Range: -	Unit: -	Default: 00000000 hex	
Size: 4 bytes (INT32)	Access: RW	PDO map: Possible	
Sub-index3: Command Parameter 2			
Range: -	Unit: -	Default: 00000000 hex	
Size: 4 bytes (INT32)	Access: RW	PDO map: Possible	
Sub-index4: Command Parameter 3			
Range: -	Unit: -	Default: 00000000 hex	
Size: 4 bytes (INT32)	Access: RW	PDO map: Possible	

- Store the parameter of the command. (e.g. the scene number is stored when the command "Switch scene".)

IMPORTANT

Command Parameter 3 cannot be used in the reserved area. Use Command Parameter 0 to 2.

7003Hex	User Input Area		
Sub-index 0: Number of entries			
Setting range: -	Unit: -	Default: 00Hex	
Size: 1byte (U8)	Access: RO	PDO map: Not possible	
Sub-index 1: User Input Area 0 (User Input Area 0)			
Setting range: -	Unit: -	Default: 00000000Hex	
Size: 4bytes (INT32)	Access: RO	PDO map: Possible	
Sub-index 2: User Input Area 1 (User Input Area 1)			
Setting range: -	Unit: -	Default: 00000000Hex	
Size: 4bytes (INT32)	Access: RO	PDO map: Possible	
Sub-index 3: User Input Area 2 (User Input Area 2)			
Setting range: -	Unit: -	Default: 00000000Hex	
Size: 4bytes (INT32)	Access: RO	PDO map: Possible	
Sub-index 4: User Input Area 3 (User Input Area 3)			
Setting range: -	Unit: -	Default: 00000000Hex	
Size: 8bytes (Double)	Access: RO	PDO map: Possible	
Sub-index 5: User Input Area 4 (User Input Area 4)			
Setting range: -	Unit: -	Default: 00000000Hex	
Size: 8bytes (Double)	Access: RO	PDO map: Possible	

Sub-index 6: User Input Area 5 (User Input Area 5)		
Setting range: -	Unit: -	Default: 00000000Hex
Size: 8bytes (Double)	Access: RO	PDO map: Possible

- Saves the User Input Area.

8000 hex	Result Reporting Configuration	
Sub-index0: Number of notice		
Range: -	Unit: -	Default: 03 hex
Size: 1 byte (U8)	Access: RO	PDO map: Not possible
Sub-index1: Switch of handshake mode		
Range: -	Unit: -	Default: 00 hex
Size: 1 bit (BOOL)	Access: RW	PDO map: Not possible
Sub-index2: Result Valid period		
Range: -	Unit: -	Default: 02 hex
Size: 4 bytes (INT32)	Access: RW	PDO map: Not possible
Sub-index3: Result Notification Time		
Range: -	Unit: -	Default: 01 hex
Size: 4 bytes (INT32)	Access: RW	PDO map: Not possible

Objects are provided for each line as shown below when more than one line is used.

- Line 1 : 6010 hex (Status Signals) to 6016 hex (Image Processing Results Real Number Data)
7010 hex (Control Signals) to 7012 hex (Command Parameter)
8010 hex (Image Processing Results Output Settings)
- Line 2 : 6020 hex (Status Signals) to 6026 hex (Image Processing Results Real Number Data)
7020 hex (Control Signals) to 7022 hex (Command Parameter)
8020 hex (Image Processing Results Output Settings)
- Line 3 : 6030 hex (Status Signals) to 6036 hex (Image Processing Results Real Number Data)
7030 hex (Control Signals) to 7032 hex (Command Parameter)
8030 hex (Image Processing Results Output Settings)
- Line 4 : 6040 hex (Status Signals) to 6046 hex (Image Processing Results Real Number Data)
7040 hex (Control Signals) to 7042 hex (Command Parameter)
8040 hex (Image Processing Results Output Settings)
- Line 5 : 6050 hex (Status Signals) to 6056 hex (Image Processing Results Real Number Data)
7050 hex (Control Signals) to 7052 hex (Command Parameter)
8050 hex (Image Processing Results Output Settings)
- Line 6 : 6060 hex (Status Signals) to 6066 hex (Image Processing Results Real Number Data)
7060 hex (Control Signals) to 7062 hex (Command Parameter)
8060 hex (Image Processing Results Output Settings)
- Line 7 : 6070 hex (Status Signals) to 6076 hex (Image Processing Results Real Number Data)
7070 hex (Control Signals) to 7072 hex (Command Parameter)
8070 hex (Image Processing Results Output Settings)

F000 hex	Modular Device Profile		
Sub-index0: Number of notice			
Range: –	Unit: –	Default: 05 hex	
Size: 1 byte (U8)	Access: RO	PDO map: Not possible	
Sub-index1: Index distance			
Range: –	Unit: –	Default: 10 hex	
Size: 2 bytes (U16)	Access: RO	PDO map: Not possible	
Sub-index2: Maximum number of modules			
Range: –	Unit: –	Default: 08 hex	
Size: 2 bytes (U16)	Access: RO	PDO map: Not possible	
Sub-index3: General configuration			
Range: –	Unit: –	Default: 00 hex	
Size: 4 bytes (U32)	Access: RO	PDO map: Not possible	
Sub-index4: General information			
Range: –	Unit: –	Default: 00 hex	
Size: 4 bytes (U32)	Access: RO	PDO map: Not possible	
Sub-index5: Module PDO Group of device			
Range: –	Unit: –	Default: 00 hex	
Size: 2 bytes (U16)	Access: RO	PDO map: Not possible	
F010 hex	Module Profile List		
Sub-index0: Number of notice			
Range: –	Unit: –	Default: 08 hex	
Size: 1 byte (U8)	Access: RO	PDO map: Not possible	
Sub-index1: Profile information of the module on position 1			
Range: –	Unit: –	Default: 00 hex	
Size: 4 bytes (U32)	Access: RO	PDO map: Not possible	
Sub-index2: Profile information of the module on position 2			
Range: –	Unit: –	Default: 00 hex	
Size: 4 bytes (U32)	Access: RO	PDO map: Not possible	
Sub-index3: Profile information of the module on position 3			
Range: –	Unit: –	Default: 00 hex	
Size: 4 bytes (U32)	Access: RO	PDO map: Not possible	
Sub-index4: Profile information of the module on position 4			
Range: –	Unit: –	Default: 00 hex	
Size: 4 bytes (U32)	Access: RO	PDO map: Not possible	
Sub-index5: Profile information of the module on position 5			
Range: –	Unit: –	Default: 00 hex	
Size: 4 bytes (U32)	Access: RO	PDO map: Not possible	
Sub-index6: Profile information of the module on position 6			
Range: –	Unit: –	Default: 00 hex	
Size: 4 bytes (U32)	Access: RO	PDO map: Not possible	

Sub-index7: Profile information of the module on position 7		
Range: –	Unit: –	Default: 00 hex
Size: 4 bytes (U32)	Access: RO	PDO map: Not possible
Sub-index8: Profile information of the module on position 8		
Range: –	Unit: –	Default: 00 hex
Size: 4 bytes (U32)	Access: RO	PDO map: Not possible
F030 hex Configured Module Ident List1		
Sub-index0: Number of notice		
Range: –	Unit: –	Default: 08 hex
Size: 1 byte (U8)	Access: RO	PDO map: Not possible
Sub-index1: Module Ident of the module configured on position 1		
Range: –	Unit: –	Default: 00 hex
Size: 4 bytes (U32)	Access: RW	PDO map: Not possible
Sub-index2: Module Ident of the module configured on position 2		
Range: –	Unit: –	Default: 00 hex
Size: 4 bytes (U32)	Access: RW	PDO map: Not possible
Sub-index3: Module Ident of the module configured on position 3		
Range: –	Unit: –	Default: 00 hex
Size: 4 bytes (U32)	Access: RW	PDO map: Not possible
Sub-index4: Module Ident of the module configured on position 4		
Range: –	Unit: –	Default: 00 hex
Size: 4 bytes (U32)	Access: RW	PDO map: Not possible
Sub-index5: Module Ident of the module configured on position 5		
Range: –	Unit: –	Default: 00 hex
Size: 4 bytes (U32)	Access: RW	PDO map: Not possible
Sub-index6: Module Ident of the module configured on position 6		
Range: –	Unit: –	Default: 00 hex
Size: 4 bytes (U32)	Access: RW	PDO map: Not possible
Sub-index7: Module Ident of the module configured on position 7		
Range: –	Unit: –	Default: 00 hex
Size: 4 bytes (U32)	Access: RW	PDO map: Not possible
Sub-index8: Module Ident of the module configured on position 8		
Range: –	Unit: –	Default: 00 hex
Size: 4 bytes (U32)	Access: RW	PDO map: Not possible

F050 hex	Detected Module Ident List1		
Sub-index0: Number of notice			
Range: –	Unit: –	Default: 08 hex	
Size: 1 byte (U8)	Access: RO	PDO map: Not possible	
Sub-index1: Module Ident of the module configured on position 1			
Range: –	Unit: –	Default: 00 hex	
Size: 4 bytes (U32)	Access: RO	PDO map: Not possible	
Sub-index2: Module Ident of the module configured on position 2			
Range: –	Unit: –	Default: 00 hex	
Size: 4 bytes (U32)	Access: RO	PDO map: Not possible	
Sub-index3: Module Ident of the module configured on position 3			
Range: –	Unit: –	Default: 00 hex	
Size: 4 bytes (U32)	Access: RO	PDO map: Not possible	
Sub-index4: Module Ident of the module configured on position 4			
Range: –	Unit: –	Default: 00 hex	
Size: 4 bytes (U32)	Access: RO	PDO map: Not possible	
Sub-index5: Module Ident of the module configured on position 5			
Range: –	Unit: –	Default: 00 hex	
Size: 4 bytes (U32)	Access: RO	PDO map: Not possible	
Sub-index6: Module Ident of the module configured on position 6			
Range: –	Unit: –	Default: 00 hex	
Size: 4 bytes (U32)	Access: RO	PDO map: Not possible	
Sub-index7: Module Ident of the module configured on position 7			
Range: –	Unit: –	Default: 00 hex	
Size: 4 bytes (U32)	Access: RO	PDO map: Not possible	
Sub-index8: Module Ident of the module configured on position 8			
Range: –	Unit: –	Default: 00 hex	
Size: 4 bytes (U32)	Access: RO	PDO map: Not possible	

Communicating with PLC Link

This section describes how to set up communications, describes the communications specifications (PLC I/O memory areas and communications commands used with PLC communications), and provides communications timing charts and other information required to communicate between the Sensor Controller and an external device through PLC Link communications.

Communications Processing Flow

The Sensor Controller and external device communicate with PLC Link communications via Ethernet or RS-232C/422.

When you use Ethernet communication, connect with TCP/IP protocol and PLC Link.

IMPORTANT

- PLC Link communications can be performed via Ethernet or RS-232C/422, but not both at the same time.
- Sensor Controller side will be Client side when you connect with PLC Link via TCP/IP protocol.
- Multiple FH/FZ5 Sensor controllers, and multiple lines cannot be connected with UDP/IP communications. For multiple sensor controllers, or multiple lines, use TCP/IP.
- Duplicating setting of FINS/UDP ports in CJ/NJ series to FH/FZ5 series Output port number are not applied when you use UDP/IP communication which connects OMRON PLC CJ series or NJ/NX series and Ethernet.
- If you connect multi FH/FZ5 Sensor Controllers to a FINS/UDP port, PLC communication may be disabled. A PLC link error could be occurred.

You can use PLC Link communications to perform control from the PLC with command/response communications and to output data after measurements. (You can use these two communications methods simultaneously.)

For PLC Link communications, the following three communications areas are set in the PLC to perform communications.

Command/response method	(1) Command Area	You write the control commands to execute for the Sensor Controller to this area.
	(2) Response Area	You read the results of executing the control commands that were written to the Command Area from this area.
Data output after measurements	(3) Data Output Area	This is the area from which the user reads the data output after a measurement is performed.

You can set the area and address settings in the communications specifications of the Sensor Controller to assign the above three communications areas in the I/O memory of the PLC.

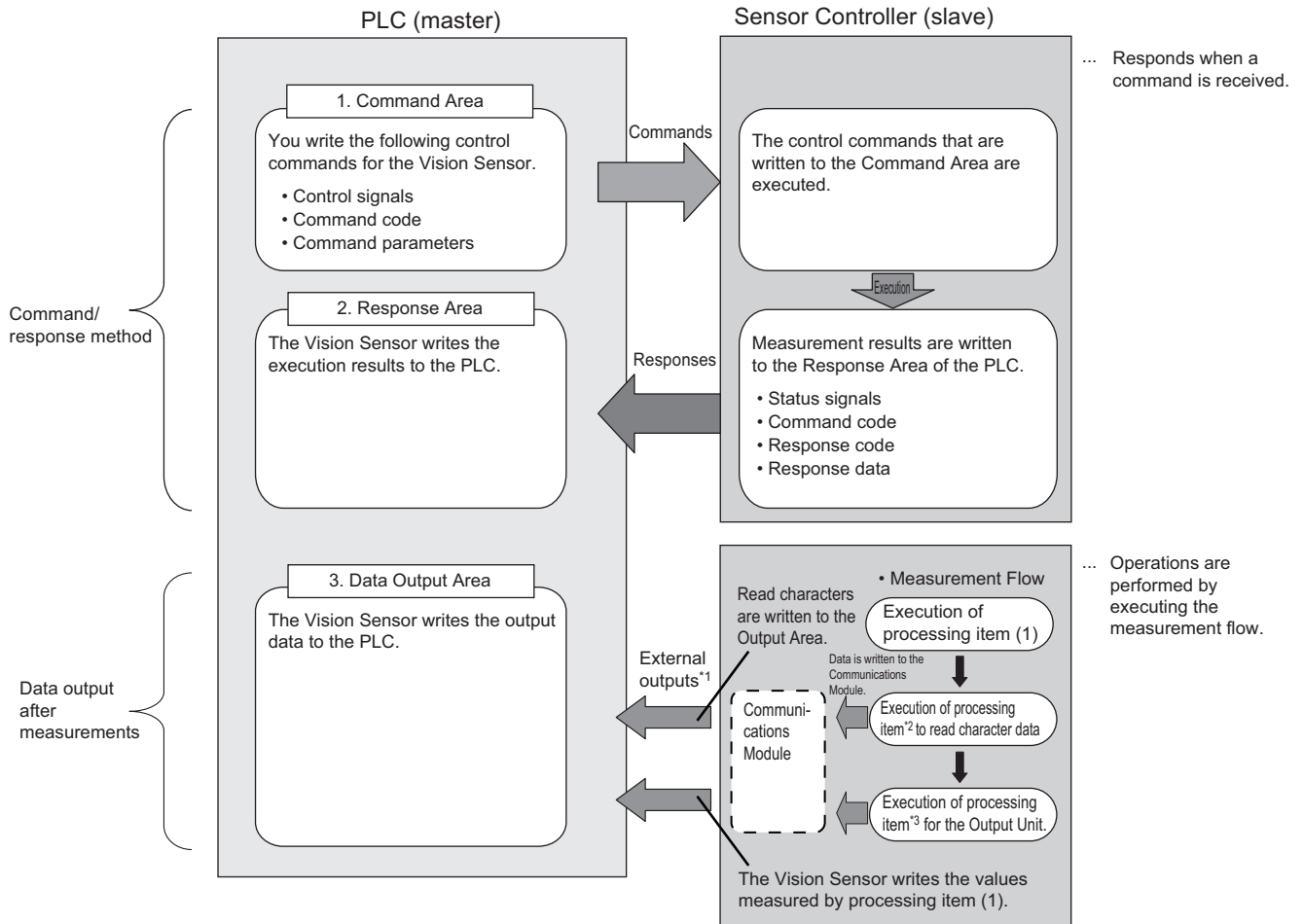

*1: You can use output controls (handshaking) to prevent output data from being externally output from the communications buffer until the Controller (master) turns ON the DSA signal to request the output data.

*2: The following processing items are used to read characters:
Character Inspection, Barcode, 2DCode, and OCR

*3: Reference: ► Settings Required for Data Output (p.29) for information on the Output Units that output measurement data.

Note

The PLC Link protocol communicates using three link areas: Command Area, Response Area, and Data Output Area. It is different from the serial PLC Link protocol used to inter-connect OMRON PLCs serially.

IMPORTANT

In the default settings for PLC Link communications, the data output processing method is set to the same processing used for models prior to the FZ4.

This setting synchronizes the measurement processing and data output processing so that all data output processing finishes when measurement finishes. However, this makes the overall processing time for the measurement flow longer.

If required for your application, change the communications settings to Asynchronous Output Mode, which performs measurement processing and data output processing in parallel. Reference: ► Asynchronous Output (p.182)

Communications Setup Procedures

The following settings are required to use PLC Link communications.

- | | |
|--|---|
| 1. Communications Module settings (startup settings) | <p>... The communication method to be used is determined by selecting a communication module.
Reference: ► Communications Module Settings (Startup Settings) (p.164)</p> |
| ↓ | |
| 2. Communications specifications settings | <p>... The communications specifications are set for the communications method of the Communications Module that was selected in step 1.
Set the communications area assignments for exchanging data with the external device.
Reference: ► Communications Specifications Settings (p.166)</p> |
| ↓ | |
| 3. Output data settings (processing item registration) | <p>... The data to output to the Data Output Area is registered in the Output Unit. The Output Unit is placed in the measurement flow in the same way as for other processing items.
Reference: ► Output Data Settings (Processing Item Registration) (p.184)</p> |
| ↓ | |
| 4. Testing communications | <p>... If communications are not working properly, check the communications setup from step 2 and perform a communications test to determine if the Sensor Controller can be detected on the network.
If that does not solve the problem, refer to the troubleshooting section.
Reference: ► Testing Communications (p.189)</p> |

Communications Module Settings (Startup Settings)

The communication method used for communication with the Sensor Controller is selected from the communication modules.

- 1 On the Main Window, select [Tool] – [System Settings].**
- 2 Select [System setting] – [Startup] – [Startup setting] on the Multiview Explorer on the left and then click [Communication].**

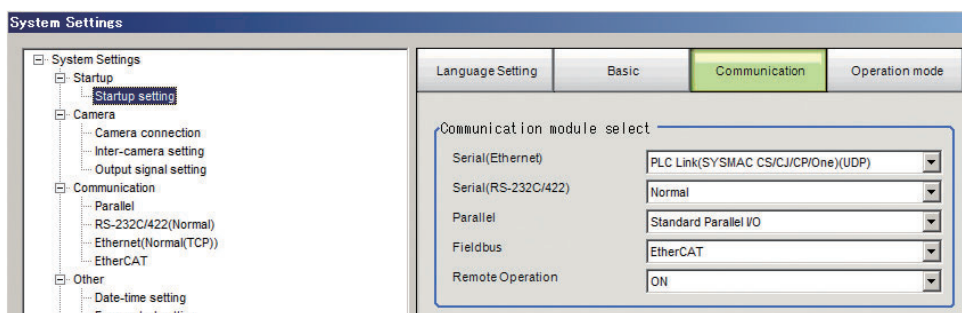

- 3** Select one of the following Communications Modules based on the communications method that is used to connect with the Sensor Controller and the Unit to connect to, then click [Apply].

Communications Module	Description
Serial (Ethernet)	Performs PLC Link communications via an Ethernet connection.
PLC Link (SYSMAC CS/CJ/CP/One)(UDP)	Select this Communications Module to UDP communicate with an OMRON PLC.
PLC Link (SYSMAC CS/CJ/CP/One)(TCP)	Select this Communications Module to TCP communicate with an OMRON PLC.
PLC Link (MELSEC QnU/Q/QnAS)(UDP)	Select this Communications Module to UDP communicate with a Mitsubishi Electric PLC.
PLC Link (MELSEC QnU/Q/QnAS)(TCP)	Select this Communications Module to TCP communicate with a Mitsubishi Electric PLC.
PLC Link (JEPMC MP)	Select this Communications Module to communicate with a Yaskawa Electric PLC.
Serial (RS-232C/422)	Performs PLC Link communications via an RS-232C/422 connection.
PLC Link (SYSMAC CS/CJ/CP/One)	Select this Communications Module to communicate with an OMRON PLC.
PLC Link (MELSEC QnU/Q/QnAS)	Select this Communications Module to communicate with a Mitsubishi Electric PLC.

Note

- Normally select UDP communication module when serial is set as Ethernet.
Select TCP communication module if that is the recommended method for your particular communication environment.

- 4** Click the [Data save] button in the Toolbar.

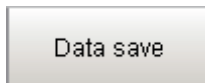

- 5** On the Main Window, select [Function] – [System restart].

Click [OK] in the [System restart] dialog box to restart the Sensor Controller.

- 6** When the Sensor Controller has restart, operation will be performed for the default settings of the specified Communications Module.

Set the IP address and other settings for the PLC or other external device.

IMPORTANT

After you set the Communications Module, always click [Data save] and then restart the Sensor Controller. If the settings are not saved and the Sensor Controller is not restarted, the new Communications Module settings will not be enabled.

Note

You can save the Communications Module settings to a file.
Select [Save to file] from the [Function] menu, and then select [System data] or [System + Scene group 0 data] to save the settings data to a file.
Refer to ► *Saving Settings Data to the Controller RAM Disk or an External Memory Device* in the *Vision System FH/FZ5 Series User's Manual* (Cat. No. Z365).

Communications Specifications Settings

Communications specifications, such as the link areas, baud rate, and data length, are set. The communications settings must be set separately for Ethernet and RS-232C communications. If communications cannot be performed even after setting these communications settings, check the settings and the communications status. (Reference: ► Testing Communications (p.189))

IMPORTANT

- The settings dialog box for the communications specifications will change depending on the Communications Module that you use.
Before you set the communications specifications, select the Communications Module to use with the Sensor Controller in the startup settings. (Reference: ► Communications Module Settings (Startup Settings) (p.62))
After you select the Communications Module, save the settings to the Sensor Controller and restart the Sensor Controller.
If you do not restart the Sensor Controller, the selected Communications Module will not be enabled.
- Use the same communications settings for the Sensor Controller and the external device.
- Do not input signals to Ethernet from an external device while setting the Ethernet system settings.

Connecting via Ethernet

1 On the Main Window, select [Tool] – [System Settings].

Select [System Settings] and then select [Communication] – [Ethernet (PLC Link (SYSMAC CS/CJ/CP/One))], [Ethernet (PLC Link (MELSEC QnU/Q/QnAS))], or [Ethernet (PLC Link (JEPMC MP))]. The Ethernet View is displayed.

2 In the communications setting areas, set the following items.

When you connect with [Ethernet (PLC Link (SYSMAC CS/CJ/One)(UDP)] communication.

The screenshot shows the following settings:

Field	Address setting	Address setting 2	Input/Output setting
Obtain an IP address automatically	<input type="radio"/>	<input type="radio"/>	
Use the following IP address	<input checked="" type="radio"/>	<input checked="" type="radio"/>	
IP address	10.5.5.100	10.5.6.100	0.0.0.0
Subnet mask	255.255.255.0	255.255.255.0	
Default gateway	10.5.5.100	10.5.6.100	
DNS server	10.5.5.100	10.5.6.100	
Preferred WINS server	0.0.0.0	0.0.0.0	
Alternate WINS server	0.0.0.0	0.0.0.0	
Output IP address			0.0.0.0
Input/Output port No.			9600

Note

-
- An FH-1000/FH-3000 series Sensor Controller with four or eight Camera inputs has two Ethernet ports.
Set the settings for the two Ethernet ports as follows:
 - Communications Module Settings
Use the same setting for both ports.
 - IP Address Setting
Set a different IP address for each Ethernet port.
The IP address for the top Ethernet port is set in [Address setting], and the IP address for the bottom Ethernet port is set in [Address setting 2]. Note that the FH prioritizes the bottom port, so when there is a high network load, communication on the top port may be delayed or in some cases communication data may be lost. By using both Ethernet ports simultaneously, you can use the bottom port for PLC Link, non-procedure, Ethernet, or IP communications with a PLC and the top port for FTP or remote operation communications with an external device.
 - The following Sensor Controller type has one Ethernet port:
 - FH-L series
FH-1000/FH-3000 series with two camera inputs
In this case, the IP address of the Ethernet port is set in [Address setting 2].
 - The FZ5 has only one Ethernet port.
In this case, the IP address of the Ethernet port is set in the [Address setting].
-

Setting item	Set value [Factory default]	Description
Address Settings		
Address Settings is only for the following series:		
<ul style="list-style-type: none"> • FH-1000 series (4, 8 camera type) • FH-3000 series (4, 8 camera type) • FZ5 series Sensor Controller 		
	<ul style="list-style-type: none"> • Obtain an IP address automatically • [Use the following IP address] 	Use the following IP address When [Obtain an IP address automatically] is selected, the IP address of the Sensor Controller will be automatically obtained. When [Use the following IP address] is selected, set the IP address, subnet mask, and the default gateway address.
IP address	a.b.c.d a: 1 to 223 b: 0 to 255 c: 0 to 255 d: 2 to 254 [10.5.5.100]	Input the IP address of the Sensor Controller.
Subnet mask	0.0.0.0 to 255.255.255.255 [255.255.255.0]	Input the subnet mask address.
Default gateway	a.b.c.d a: 1 to 223 b: 0 to 255 c: 0 to 255 d: 0 to 255 [10.5.5.100]	Input the default gateway address.
DNS server	a.b.c.d a: 1 to 223 b: 0 to 255 c: 0 to 255 d: 0 to 255 [10.5.5.100]	Input the DNS server address.
Preferred WINS server	a.b.c.d a: 1 to 223 b: 0 to 255 c: 0 to 255 d: 0 to 255 [0.0.0.0.]	Inputs address of WINS server.
Alternate WINS server	a.b.c.d a: 1 to 223 b: 0 to 255 c: 0 to 255 d: 0 to 255 [0.0.0.0]	Inputs address of WINS server.

Setting item	Set value [Factory default]	Description	
Address setting 2 Address Settings is only for the following series: • FH-1000 series (2 camera type) • FH-3000 series (2 camera type) • FH-L series Sensor Controller		Set the IP address of the bottom Ethernet port on the Sensor Controller.	
	<ul style="list-style-type: none"> • Obtain an IP address automatically • [Use the following IP address] 	Same as [Address setting].	
IP address	a.b.c.d a: 1 to 223 b: 0 to 255 c: 0 to 255 d: 2 to 254 [10.5.6.100]		
Subnet mask	0.0.0.0 to 255.255.255.255 [255.255.255.0]		
Default gateway	a.b.c.d a: 1 to 223 b: 0 to 255 c: 0 to 255 d: 2 to 255 [10.5.6.100]		
DNS server	a.b.c.d a: 1 to 223 b: 0 to 255 c: 0 to 255 d: 0 to 255 [10.5.6.100]		
Preferred WINS server	a.b.c.d a: 1 to 223 b: 0 to 255 c: 0 to 255 d: 0 to 255 [0.0.0.0]		Inputs address of WINS server.
Alternate WINS server	a.b.c.d a: 1 to 223 b: 0 to 255 c: 0 to 255 d: 0 to 255 [0.0.0.0]		Inputs address of WINS server.
Input/Output settings			
Output IP Address/TCP Server *1	a.b.c.d a: 0 to 255 b: 0 to 255 c: 0 to 255 d: 1 to 254 [0.0.0.0]/[10.5.5.101]*1	Input the output destination IP address. *1: When you connect with the TCP. [TCP Server] is displayed. Factory default value is [10.5.5.101].	
Input/Output port No.	0 to 65535 [9600]/[9876]*2	Set the port No. to use for data I/O with the Sensor Controller. *2: When you connect with the TCP. Factory default value is [9876].	

IMPORTANT

- If the operation mode is set to Multi-line Random-trigger Mode, set a different I/O port number for each line.
- Change the IP address and subnet mask for [Address setting] and [Address setting 2] as required so that each designate a different network address. If the same network address is specified, communications may not be performed correctly.
- Be sure to change the output IP address from its factory default value in accordance with your network environment.

3 Click [PLC link].

The PLC Link Setting View is displayed.

4 Set the following items.

Some setting items will change depending on the selected Communications Module.

The screenshot shows the 'PLC Link' configuration window. It has two tabs: 'Setting' and 'PLC Link', with 'PLC Link' being the active tab. The window is divided into several sections:

- Command area:** 'Area' is set to 'CIO Area(CIO)' and 'Address' is set to '0'.
- Response area:** 'Area' is set to 'CIO Area(CIO)' and 'Address' is set to '100'.
- Data Output area:** 'Area' is set to 'CIO Area(CIO)' and 'Address' is set to '200'.
- Output control:** Set to 'Handshaking'. There is an unchecked checkbox for 'Asynchronous output'.
- Retry interval [ms]:** Set to '10000'.
- Retry interval 2 [ms]:** Set to '1000'.
- Polling cycle:** Set to '0'.

Each address field and the retry interval fields have increment and decrement buttons. The 'Area' fields are dropdown menus.

• **Communicating with an OMRON PLC**

(When [PLC Link (Sysmac CS/CJ/CP/One)] is selected for the Communications Module)

Setting item	Set value [Factory default]	Description
Command area		
Area	<ul style="list-style-type: none"> • [CIO Area (CIO)] • Work Area (WR) • Holding Bit Area (HR) • Auxiliary Bit Area (AR) • DM Area (DM) • EM Area (EM0 to EMC) 	Set the Command Area. The range of the EM Area depends on the model of the CPU Unit of the connected PLC.
Address	0 to 99999 [0]	Set the first word address in the Command Area.
Response area		
Area	<ul style="list-style-type: none"> • [CIO Area (CIO)] • Work Area (WR) • Holding Bit Area (HR) • Auxiliary Bit Area (AR) • DM Area (DM) • EM Area (EM0 to EMC) 	Set the Response Area. The range of the EM Area depends on the model of the CPU Unit of the connected PLC.
Address	0 to 99999 [100]	Set the first word address in the Response Area.
Data output area		
Area	<ul style="list-style-type: none"> • [CIO Area (CIO)] • Work Area (WR) • Holding Bit Area (HR) • Auxiliary Bit Area (AR) • DM Area (DM) • EM Area (EM0 to EMC) 	Set the Data Output Area. The range of the EM Area depends on the model of the CPU Unit of the connected PLC.
Address	0 to 99999 [200]	Set the first word address in the Data Output Area.
Output control	<ul style="list-style-type: none"> • None • [Handshaking] 	Set whether to provide an interlock with the PLC when performing data output. None: Data is output regardless of the status of signals from the PLC. GATE is always OFF. Handshaking: Data is output after confirming DSA from the PLC.

Setting item	Set value [Factory default]	Description
Asynchronous output	<ul style="list-style-type: none"> • Selected. • [Not selected.] 	<p>Selected: Measurement processing and data output processing are performed in parallel. The data output processing does not affect the processing time of the measurement flow.</p> <p>IMPORTANT</p> <p>Always set the output control to [Handshaking] for asynchronous output. If you set the output control to [None], operation will be fixed at the following values: Output time: 100 ms, Output period: 200 ms. If you need a shorter output time and output period when the output control is set to [None], do not select asynchronous output.</p> <p>Not selected: Measurement processing and data output processing are synchronized so that all data output processing is finished when measurements are finished. This increases the overall processing time of the measurement flow.</p> <p>Note</p> <p>This is the same as the PLC Link operation of the FZ4 Vision Sensor.</p> <p>Reference: ► Asynchronous Output (p.182)</p>
Retry interval [ms]	0 to 999999 [10000]	<p>Set the time after which a timeout error will occur due to failing in establishing PLC link communications. *1</p> <p>The error is caused by making incorrect communication settings or disconnection of communication cables, and similar causes. After a timeout error occurs, communications with the destination device will be attempted at the interval time that is set as the retry interval.</p> <p>Reference: ► Data Output Control with Handshaking (p.32)</p> <p>*1: If handshaking is enabled, a timeout error will also occur if any of the following operations are not performed during the [Retry interval].</p> <ul style="list-style-type: none"> • If the DSA signal is not turned ON after a certain time elapses from when measurements are finished • If the DSA signal is not turned OFF after a certain time elapses from when the GATE signal turns ON • If the DSA signal is not turned ON after a certain time elapses from when the GATE signal turns OFF.
Retry interval 2 [ms]	0 to 999999 [1000]	<p>The command will be resent after the time that is set for "Retry interval 2" in cases where PLC link communications fail due to a temporary response delay caused by heavy network loads, processing conditions on a PLC, and similar causes. Set the time so that the time set for "Retry interval 2" is shorter than the time set for "Retry interval". Normally the setting should not be changed.</p>
Polling cycle [ms]	-1 to 999999 [0]	<p>0 to 999999: Set the interval at which the FH/FZ5 Sensor Controller checks for the Command Execute (EXE) signal from an external device, i.e., PLC, turning from OFF to ON.</p> <p>-1: If this value is set, polling will not be performed during normal operation.</p> <p>This setting prevents communications (polling) from affecting the measurement processing time during normal operation. Commands cannot be executed, but data output and flow control can be performed.</p>

• **Communicating with a Mitsubishi Electric PLC**

(When [PLC Link (MELSEC/QnU/Q/QnAS)] is selected for the Communications Module)

Setting item	Set value [Factory default]	Description
Command area		
Area	<ul style="list-style-type: none"> • [Data register] • File register • Link register 	Set the Command Area.
Address	0 to 99999 [0]	Set the first word address in the Command Area.
Response area		
Area	<ul style="list-style-type: none"> • [Data register] • File register • Link register 	Set the Response Area.
Address	0 to 99999 [100]	Set the first word address in the Response Area.
Data output area		
Area	<ul style="list-style-type: none"> • [Data register] • File register • Link register 	Set the Data Output Area.
Address	0 to 99999 [200]	Set the first word address in the Data Output Area.
Output control	<ul style="list-style-type: none"> • None • [Handshaking] 	<p>Set whether to provide an interlock with the PLC when performing data output.</p> <p>None: Data is output regardless of the status of signals from the PLC. GATE is always OFF.</p> <p>Handshaking: Data is output after confirming DSA from the PLC.</p>
Asynchronous output	<ul style="list-style-type: none"> • Selected. • [Not selected.] 	<p>Selected: Measurement processing and data output processing are performed in parallel. The data output processing does not affect the processing time of the measurement flow.</p> <p>IMPORTANT</p> <p>Always set the output control to [Handshaking] for asynchronous output. If you set the output control to [None], operation will be fixed at the following values: Output time: 100 ms, Output period: 200 ms. If you need a shorter output time and output period when the output control is set to [None], do not select asynchronous output.</p> <p>Not selected: Measurement processing and data output processing are synchronized so that all data output processing is finished when measurements are finished. This increases the overall processing time of the measurement flow.</p> <p>Note</p> <p>This is the same as the PLC Link operation of the FZ4 Vision Sensor.</p> <p>Reference: ► Asynchronous Output (p.182)</p>

Setting item	Set value [Factory default]	Description
Retry interval [ms]	0 to 999999 [10000]	<p>Set the time after which a timeout error will occur due to failing in establishing PLC link communications. *1</p> <p>The error is caused by making incorrect communication settings or disconnection of communication cables, and similar causes.</p> <p>After a timeout error occurs, communications with the destination device will be attempted at the interval time that is set as the retry interval.</p> <p>Reference: ► Data Output Control with Handshaking (p.32)</p> <p>*1: If handshaking is enabled, a timeout error will also occur if any of the following operations are not performed during the [Retry interval].</p> <ul style="list-style-type: none"> • If the DSA signal is not turned ON after a certain time elapses from when measurements are finished • If the DSA signal is not turned OFF after a certain time elapses from when the GATE signal turns ON. • If the DSA signal is not turned ON after a certain time elapses from when the GATE signal turns OFF.
Retry interval 2 [ms]	0 to 999999 [1000]	<p>The command will be resent after the time that is set for "Retry interval 2" in cases where PLC link communications fail due to a temporary response delay caused by heavy network loads, processing conditions on a PLC, and similar causes. Set the time so that the time set for "Retry interval 2" is shorter than the time set for "Retry interval". Normally the setting should not be changed.</p>
Polling cycle [ms]	-1 to 999999 [0]	<p>0 to 999999: Set the interval at which the FH/FZ5 Sensor Controller checks for the Command Execute (EXE) signal from an external device, i.e., PLC, turning from OFF to ON.</p> <p>-1: If this value is set, polling will not be performed during normal operation. This setting prevents communications (polling) from affecting the measurement processing time during normal operation. Commands cannot be executed, but data output and flow control can be performed.</p>

• **Communicating with a Yaskawa Electric PLC**

(When [PLC Link (JEPMC MP)] is selected for the Communications Module)

Setting item	Set value [Factory default]	Description
Command area		
Area	Data register	Data registers are always used for the Command Area.
Address	0 to 99999 [0]	Set the first word address in the Command Area.
Response area		
Area	Data register	Data registers are always used for the Response Area.
Address	0 to 99999 [100]	Set the first word address in the Response Area.
Data output area		
Area	Data register	Data registers are always used for the Data Output Area.
Address	0 to 99999 [200]	Set the first word address in the Data Output Area.
Output control	<ul style="list-style-type: none"> • None • [Handshaking] 	<p>Sets whether to establish an interlock with the PLC when data is output.</p> <p>None: Data is output regardless of the status of signals from the PLC. GATE is always OFF.</p> <p>Handshaking: Data is output after confirming DSA from the PLC.</p>
Asynchronous output	<ul style="list-style-type: none"> • Selected. • [Not selected.] 	<p>Selected: Measurement processing and data output processing are performed in parallel. The data output processing does not affect the processing time of the measurement flow.</p> <p>IMPORTANT</p> <p>Always set the output control to [Handshaking] for asynchronous output. If you set the output control to [None], operation will be fixed at the following values: Output time: 100 ms, Output period: 200 ms.</p> <p>If you need a shorter output time and output period when the output control is set to [None], do not select asynchronous output.</p> <p>Not selected: Measurement processing and data output processing are synchronized so that all data output processing is finished when measurements are finished. This increases the overall processing time of the measurement flow.</p> <p>Note</p> <p>This is the same as the PLC Link operation of the FZ4 Vision Sensor.</p> <p>Reference: ► Asynchronous Output (p.182)</p>
Retry interval [ms]	0 to 999999 [10000]	<p>Set the time after which a timeout error will occur due to failing in establishing PLC link communications. *1</p> <p>The error is caused by making incorrect communication settings or disconnection of communication cables, and similar causes.</p> <p>After a timeout error occurs, communications with the destination device will be attempted at the interval time that is set as the retry interval.</p> <p>Reference: ► Data Output Control with Handshaking (p.32)</p> <p>*1: If handshaking is enabled, a timeout error will also occur if any of the following operations are not performed during the [Retry interval].</p> <ul style="list-style-type: none"> • If the DSA signal is not turned ON after a certain time elapses from when measurements are finished • If the DSA signal is not turned OFF after a certain time elapses from when the GATE signal turns ON • If the DSA signal is not turned ON after a certain time elapses from when the GATE signal turns OFF.

Setting item	Set value [Factory default]	Description
Retry interval 2 [ms]	0 to 999999 [1000]	The command will be resent after the time that is set for "Retry interval 2" in cases where PLC link communications fail due to a temporary response delay caused by heavy network loads, processing conditions on a PLC, and similar causes. Set the time so that the time set for "Retry interval 2" is shorter than the time set for "Retry interval". Normally the setting should not be changed.
Polling cycle [ms]	-1 to 999999	0 to 999999: Set the interval at which the FH/FZ5 Sensor Controller checks for the Command Execute (EXE) signal from an external device, i.e., PLC, turning from OFF to ON. -1: If this value is set, polling will not be performed during normal operation. This setting prevents communications (polling) from affecting the measurement processing time during normal operation. Commands cannot be executed, but data output and flow control can be performed.

5 Click [Apply] to apply the settings.

Click [Close] to close the System Settings Dialog Box.

Connecting via RS-232C

1 On the Main Window, select [Tool] – [System Settings].

Select [System Settings] and then select [Communication] – [RS-232C/422 (PLC Link (SYSMAC CS/CJ/CP/One))] or [RS-232C/422 (PLC Link (MELSEC QnU/Q/QnAS))].

The serial interface window is displayed.

2 In the communications setting area, set the following items.

Setting	PLC Link
Interface :	RS-232C
Baud rate [bps] :	9600
Data length [bit] :	7
Parity :	Even
Stop bit [bit] :	2
Flow control :	None
Timeout [s] :	5 ...

Setting item	Set value [Factory default]	Description
Interface	<ul style="list-style-type: none"> • [RS-232C] • RS-422^{*3} 	Adjust to the PLC communications specifications. If you connect to an OMRON PLC, set the PLC to Host Link communications.
Baud rate [bps] ^{*1}	<ul style="list-style-type: none"> • 2400 • 4800 • [9600] • 19200 • 38400 • 57600 • 115200 	Adjust to the PLC communications specifications.
Data length [bit] ^{*2}	<ul style="list-style-type: none"> • [7] • 8 	Adjust to the PLC communications specifications.
Parity	<ul style="list-style-type: none"> • None • Odd • [Even] 	
Stop bit [bits]	<ul style="list-style-type: none"> • 1 • [2] 	
Flow control	[None]	Flow control is not performed with software. If the time in which there is no response from external devices reaches the timeout setting time, a timeout error occurs and an error message is displayed in the window. The parallel interface ERROR signal also turns ON.
	Xon/Xoff	Flow control is performed with software. Data is sent according to the Xon/Xoff codes from external devices.
Timeout [s]	1 to 120 [5]	Set the time after which a flow control (Xon/Xoff) timeout error will occur.

*1: If a baud rate of [38400 bps] or higher is selected, effective communications may not be possible depending on the cable length because speeds of over 20 Kbps are not defined in RS-232C standards. In this case, set the baud rate to [19200 bps] or lower.

*2: With the RS-232C MELSEC Q Series, set the data length to 8.

*3: RS-422 cannot be used with the MELSEC Q Series. and the FH Series.

3 Click [PLC link].

The PLC Link Setting View is displayed.

4 Set the following items.

Some setting items will change depending on the selected Communications Module.

The screenshot shows a software window titled "Setting" with a sub-tab "PLC Link". The window contains several configuration sections:

- Command area:** Area: CIO Area(CIO) (dropdown), Address: 0 (input field with a "..." button).
- Response area:** Area: CIO Area(CIO) (dropdown), Address: 100 (input field with a "..." button).
- Data Output area:** Area: CIO Area(CIO) (dropdown), Address: 200 (input field with a "..." button).
- Output control:** Handshaking (dropdown), Asynchronous output.
- Retry interval [ms]:** 10000 (input field with "..." button and left/right arrow buttons).
- Polling cycle:** 0 (input field with "..." button and left/right arrow buttons).

• **Communicating with an OMRON PLC**

(When [PLC Link (Sysmac CS/CJ/CP/One)] is selected for the Communications Module)

Setting item	Set value [Factory default]	Description
Command area		
Area	<ul style="list-style-type: none"> • [CIO Area (CIO)] • Work Area (WR) • Holding Bit Area (HR) • Auxiliary Bit Area (AR) • DM Area (DM) • EM Area (EM0 to EMC) 	Set the Command Area.
Address	0 to 99999 [0]	Set the first word address in the Command Area.
Response area		
Area	<ul style="list-style-type: none"> • [CIO Area (CIO)] • Work Area (WR) • Holding Bit Area (HR) • Auxiliary Bit Area (AR) • DM Area (DM) • EM Area (EM0 to EMC) 	Set the Response Area.
Address	0 to 99999 [100]	Set the first word address in the Response Area.
Data output area		
Area	<ul style="list-style-type: none"> • [CIO Area (CIO)] • Work Area (WR) • Holding Bit Area (HR) • Auxiliary Bit Area (AR) • DM Area (DM) • EM Area (EM0 to EMC) 	Set the Data Output Area.
Address	0 to 99999 [200]	Set the first word address in the Data Output Area.

Setting item	Set value [Factory default]	Description
Output control	<ul style="list-style-type: none"> • None • [Handshaking] 	<p>Set whether to provide an interlock with the PLC when performing data output.</p> <p>None: Data is output regardless of the status of signals from the PLC. GATE is always OFF.</p> <p>Handshaking: Data is output after confirming DSA from the PLC.</p>
Asynchronous output	<ul style="list-style-type: none"> • Selected. • [Not selected.] 	<p>Selected: Measurement processing and data output processing are performed in parallel.</p> <p>The data output processing does not affect the processing time of the measurement flow.</p> <p>IMPORTANT</p> <p>Always set the output control to [Handshaking] for asynchronous output. If you set the output control to [None], operation will be fixed at the following values: Output time: 100 ms, Output period: 200 ms.</p> <p>If you need a shorter output time and output period when the output control is set to [None], do not select asynchronous output.</p> <p>Not selected: Measurement processing and data output processing are synchronized so that all data output processing is finished when measurements are finished.</p> <p>This increases the overall processing time of the measurement flow.</p> <p>Note</p> <p>This is the same as the PLC Link operation of the FZ4 Vision Sensor.</p> <p>Reference: ► Asynchronous Output (p.182)</p>
Retry interval [ms]	0 to 999999 [10000]	<p>Used to set the time for generating a timeout error. *1</p> <p>After a timeout error occurs, communication to check the remote device is attempted for the amount of time set for this [Retry interval] setting.</p> <p>*1: During [Handshaking] communication, a timeout also occurs when any of the following operations is not executed during the time set for [Retry interval]:</p> <ul style="list-style-type: none"> • DSA signal not switched from OFF to ON when set amount of time has elapsed after completion of measurement • DSA signal not switched from ON to OFF when set amount of time has elapsed after GATE signal has been switched from OFF to ON • DSA signal not switched from OFF to ON when set amount of time has elapsed after GATE signal has been switched from ON to OFF
Polling cycle [ms]	-1 to 999999 [0]	<p>0 to 999999:</p> <p>Set the interval at which the FH/FZ5 Sensor Controller checks for the Command Execute (EXE) signal from an external device, i.e., PLC, turning from OFF to ON.</p> <p>-1: If this value is set, polling will not be performed during normal operation.</p> <p>This setting prevents communications (polling) from affecting the measurement processing time during normal operation. Commands cannot be executed, but data output and flow control can be performed.</p>

• **Communicating with a Mitsubishi Electric PLC**

(When [PLC Link (MELSEC/QnU/Q/QnAS)] is selected for the Communications Module)

Setting item	Set value [Factory default]	Description
Command area		
Area	<ul style="list-style-type: none"> • [Data register] • File register • Link register 	Set the Command Area.
Address	0 to 99999 [0]	Set the first word address in the Command Area.
Response area		
Area	<ul style="list-style-type: none"> • [Data register] • File register • Link register 	Set the Response Area.
Address	0 to 99999 [100]	Set the first word address in the Response Area.
Data output area		
Area	<ul style="list-style-type: none"> • [Data register] • File register • Link register 	Set the Data Output Area.
Address	0 to 99999 [200]	Set the first word address in the Data Output Area.
Output control	<ul style="list-style-type: none"> • None • [Handshaking] 	<p>Set whether to provide an interlock with the PLC when performing data output.</p> <p>None: Data is output regardless of the status of signals from the PLC. GATE is always OFF.</p> <p>Handshaking: Data is output after confirming DSA from the PLC.</p>
Asynchronous output	<ul style="list-style-type: none"> • Selected. • [Not selected.] 	<p>Selected: Measurement processing and data output processing are performed in parallel.</p> <p>The data output processing does not affect the processing time of the measurement flow.</p> <p>IMPORTANT</p> <p>Always set the output control to [Handshaking] for asynchronous output. If you set the output control to [None], operation will be fixed at the following values: Output time: 100 ms, Output period: 200 ms.</p> <p>If you need a shorter output time and output period when the output control is set to [None], do not select asynchronous output.</p> <p>Not selected: Measurement processing and data output processing are synchronized so that all data output processing is finished when measurements are finished.</p> <p>This increases the overall processing time of the measurement flow.</p> <p>Note</p> <p>This is the same as the PLC Link operation of the FZ4 Vision Sensor.</p> <p>Reference: ► Asynchronous Output (p.182)</p>

Setting item	Set value [Factory default]	Description
Retry interval [ms]	0 to 999999 [10000]	Used to set the time for generating a timeout error. *1 After a timeout error occurs, communication to check the remote device is attempted for the amount of time set for this [Retry interval] setting. *1: During [Handshaking] communication, a timeout also occurs when any of the following operations is not executed during the time set for [Retry interval]: <ul style="list-style-type: none"> • DSA signal not switched from OFF to ON when set amount of time has elapsed after completion of measurement • DSA signal not switched from ON to OFF when set amount of time has elapsed after GATE signal has been switched from OFF to ON • DSA signal not switched from OFF to ON when set amount of time has elapsed after GATE signal has been switched from ON to OFF
Polling cycle [ms]	-1 to 999999 [0]	0 to 999999: Set the interval at which the FH/FZ5 Sensor Controller checks for the Command Execute (EXE) signal from an external device, i.e., PLC, turning from OFF to ON. -1: If this value is set, polling will not be performed during normal operation. This setting prevents communications (polling) from affecting the measurement processing time during normal operation. Commands cannot be executed, but data output and flow control can be performed.

5 Click [Apply] to apply the settings.

Click [Close] to close the System Settings Dialog Box .

Asynchronous Output

When asynchronous output is enabled, measurement flow and data output processing are performed in parallel. In this case, data output processing does not affect the measurement flow processing in any way. Clear the option for asynchronous output if you want to perform output in the same way as for FZ4 and prior models. This enables synchronous output, which means that execution of the measurement flow continues only after the data output processing for the current measurement flow is finished. In this case, all data output processing finishes when all measurements are finished, but the overall processing time of the measurement flow is increased.

• [Asynchronous output] Not Selected

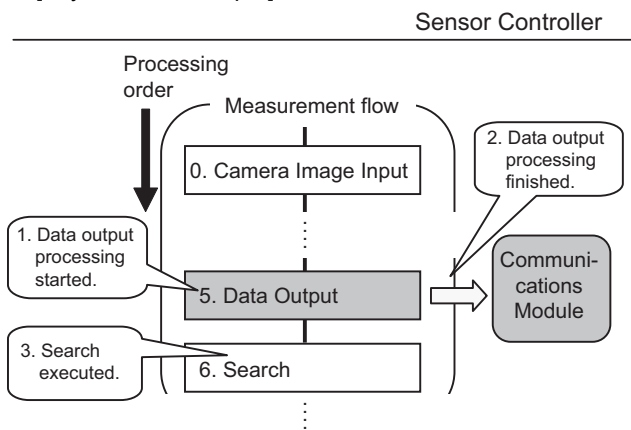

• [Asynchronous output] Selected

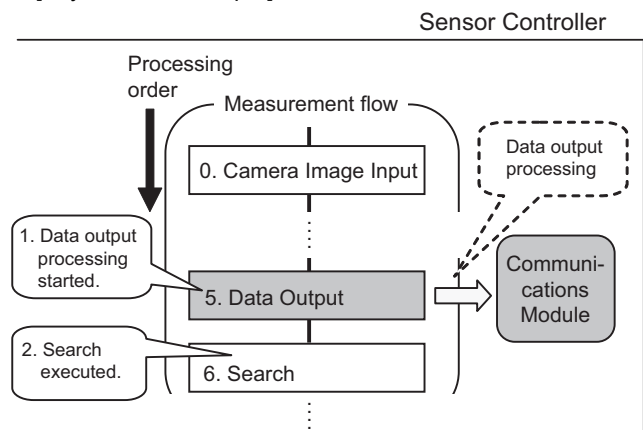

IMPORTANT

Always set the output control to [Handshaking] for asynchronous output. If you set the output control to [None], operation will be fixed at the following values: Output time: 100 ms, Output period: 200 ms.

If you need a shorter output time and output period when the output control is set to [None], do not select asynchronous output.

Output Data Settings (Processing Item Registration)

Set the items to output through PLC Link communications and the output format.

Note

When outputting characters read by a processing item such as Barcode, these settings are set in the processing item used to read the characters (Character Inspection, Barcode, or 2DCode).

Refer to the descriptions for each processing item for details on the character output settings and output format.

- Character Inspection (Refer to ► *Character Inspection* in the *Vision System FH/FZ5 Series Processing Items Reference Manual* (Cat. No. Z341).)
- Barcode (Refer to ► *Barcode* in the *Vision System FH/FZ5 Series Processing Items Reference Manual* (Cat. No. Z341).)
- 2DCode (Refer to ► *2DCode* in the *Vision System FH/FZ5 Series Processing Items Reference Manual* (Cat. No. Z341).)
- OCR (Refer ► to *OCR* in the *Vision System FH/FZ5 Series Processing Items Reference Manual* (Cat. No. Z341).)

Registering Processing Items

Register the processing items for data output in the measurement flow.

- 1 Click [Edit flow] in Toolbar.
- 2 Click [Data Output] in the processing item tree.

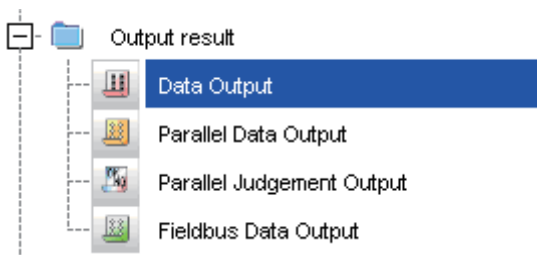

- 3 Click [Append].

The [Data Output] processing item is appended at the bottom of the unit list (flow).

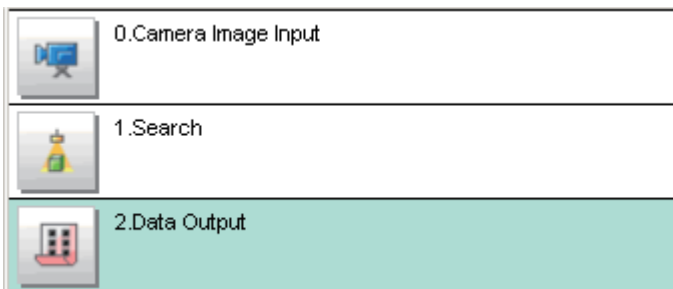

4 Click the [Data Output] icon () and set the data output items and data format.

Refer to the following reference for details on the settings.

- Reference: ► Registering the Items To Output (p.186)

Note

- The number of items that can be output in a single data output processing item is 8 to 256. If you need to output more data items, use more than one Output Unit.
If multiple Output Units are registered in the same measurement flow, the data is output to the same destination. If you do not control the output, the output data that was output first will be overwritten by the output data that is output after it. Use one of the following methods to read each set of output data.

Offset	You can offset the location where the output data is written in the Data Output Area for each Output Unit. Set the [Offset] for the Data Output processing item. Reference: Output Format (Data Output) (p.188)
Controlling data output with handshaking	If handshaking is used to control data output, the timing of outputting the data is controlled by I/O signals. Each time that data is output, read the output data and move it to a different part of I/O memory in the PLC. Reference: ► Data Output Control with Handshaking (p.32) for details on handshaking.

- Data is output in the order that data output is registered in the measurement flow, i.e., the timing is different for each data output processing item. (Data output is executed in the order that it is executed in the measurement flow.) Reference: ► Outputting the Output Data (p.27)

Registering the Items To Output

Set expressions for the data to output.

- 1 Click the [Data Output] icon () in the measurement unit list (flow).
- 2 In the Item Tab Area, click [Setting].

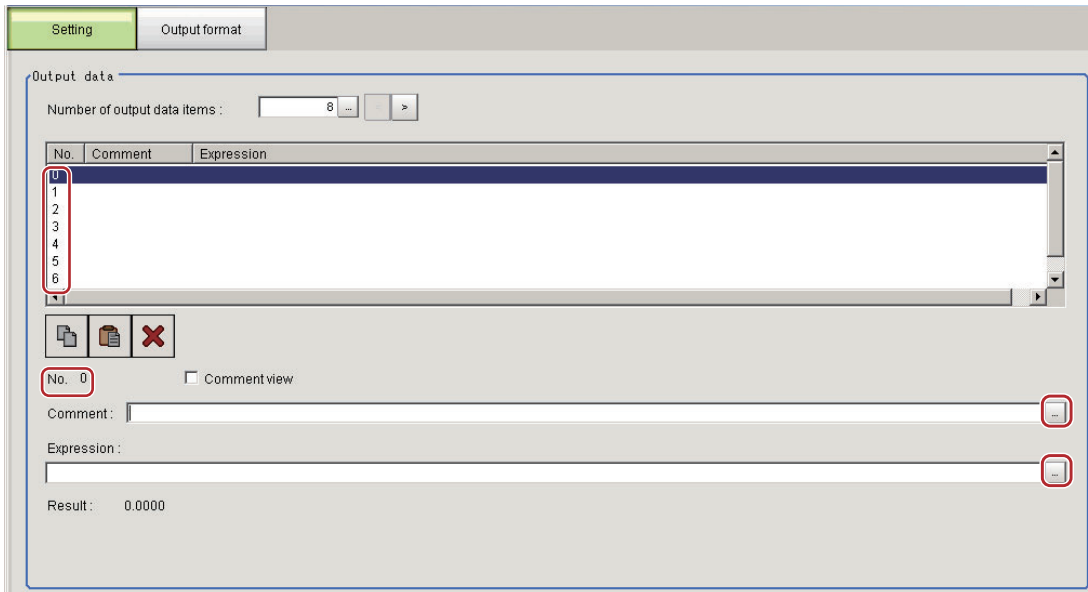

- 3 In the list, select the output data number for the expression to set.

The selected output data number is displayed under the list.

- 4 Click the [...] button next to the expression box and set the expression.



Specify the processing items, measurement results, and measurement data in the expression. You can also perform arithmetic or function calculations on the measurement data before it is output. For calculation settings, refer to section of Calculation in *FH/FZ5 Processing Item Function Reference Manual* (Cat. No. Z341).

- 5 Click the [...] button for the [Comment] box and enter an explanation of the expression.

The comment you enter will be displayed in the detailed results on the Main Window.

For example, if you enter "Test" as the comment for expression 0, "Test" will be displayed in place of "Expression 0" in the detailed results area on the Main Window.

- 6 To output more than 9 items, click on the [...] under [Number of output data items] and change the number of output items for the set Output Unit.

By default you can output only 8 items, but you can change this to output a maximum of 256 output data items (1,024 bytes).

- 7 Repeat steps 4 and 5 to set expressions for all of the required output data numbers.

Note

If you delete one of the expressions that is set for output data 0 through 255, the output numbers for all expressions after the deleted expression will stay the same. However, the actual data output will be output as though the list has been shifted forward for the number of expressions that have been deleted.

To prevent data from being written to the wrong locations, use copy and paste to manually shift the expressions after the deleted number forward.

Example: If the Expression for Output 1 Is Deleted

Output Item Settings

No.	Comment	Expression
0	Reference SX	U1.SX
1	Reference SY	U1.SY
2	Reference an...	U1.ST
3		
4		

Data Output Destination (Data Output Area)

First word	Bit	
	15	to 0
+10	DATA1 (Reference SX)	
+11		
+12	DATA2 (Reference SY)	
+13		
+14	DATA3 (Reference angle ST)	
+15		



Output 1 is deleted.

Output Item Settings

No.	Comment	Expression
0	Reference SX	U1.SX
1		
2	Reference an...	U1.ST
3		
4		

Data Output Destination (Data Output Area)

First word	Bit	
	15	to 0
+10	DATA1 (Reference SX)	
+11		
+12	DATA3 (Reference angle ST)	
+13		
+14		
+15		

The output numbers assigned to the expressions remain the same, but the data output location is shifted forward for data 3.

Output Format (Data Output)

- 1 Click the [Output format] icon () in the measurement unit list (flow).
- 2 In the Item Tab Area, click [Output format].
- 3 In the Output Setting Area, select the communications method.



Set value [Factory default]	Description
[RS-232C/RS-422]	Communications are performed via a RS-232C/RS-422 connection.
Ethernet	Communications are performed via the Ethernet.

- 4 Set the output format for the data to be output.

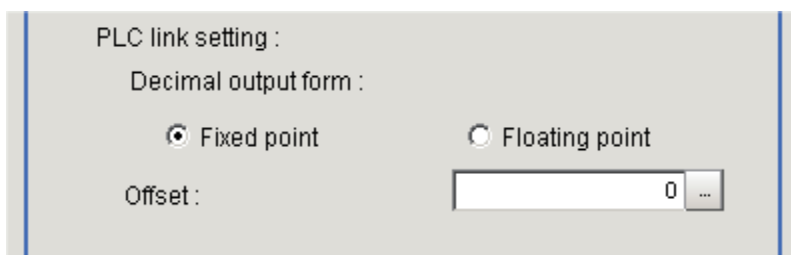

Set value [Factory default]	Description
PLC Link setting	Specify the output format for the PLC Link.
Decimal output format	When precision to 4 digits after the decimal point is required, use [Floating point].
[Fixed point]	Data is output multiplied by 1,000. Example: For 123.456, 0x0001E240
[Floating point]	Data is output in floating-point format. Example: For -123.4567, 0xc2f6e979
Offset	Set the number of offset words in the Data Output Area. 0 to 99999 (default: 0)

Testing Communications

Check to confirm that the PLC Link communications are set correctly.

If communications cannot be performed even after set up the communications, use the following procedure to check the settings and the communications status.

Ethernet Communications

Before Performing a Communications Test

This example assumes that [Serial (Ethernet)] – [PLC Link (SYSMAC CS/CJ/CP/One) (UDP)] is selected as the Communications Module.

Stop the program on the PLC when you check the communications settings.

Checking the Communications Settings

Use the following procedure to check if the communications settings are correct.

1. On the Main Window, select [Tool] – [System Settings]. Select [System data], and then select [Communication] – [PLC Link (SYSMAC CS/CJ/CP/One) (UDP)].

2. Set the IP address of the Sensor Controller. The default settings are as follows:
Address setting: 10.5.5.100
Address setting 2: 10.5.6.100

3. Sets IP address for PLC communication to the [Output IP address].

4. Set the port number to use for data I/O with the PLC in [Input port/Output port No.]. Set the same number as the destination PLC.

IMPORTANT

Be sure to match the settings on the PLC for the [Output IP address] and [Input port No.]. If these settings do not match those on the PLC, “PLC Link Error” will be displayed on the Sensor Controller.

5. Click the [PLC Link settings] tab.

6. Set the area settings. Match these settings with those on the destination PLC.

7. Set the output control. Set whether to provide an interlock with the PLC when performing data output.

8. This completes the Controller settings.

Checking the Communications Status

Use the ping command to check if the Sensor Controller exists on the Ethernet network.

Use this to determine if the Sensor Controller's IP address has been set correctly and that the Sensor Controller is correctly connected to the Ethernet network.

Note

The ping command uses the ICMP protocol to send a response request to a device connected through an Ethernet network and determines the time required to respond to that request.

If you properly receive a response from the destination device, the network connection and network settings are correctly set.

1 Connect the Sensor Controller and computer with an Ethernet cable.

Set the left segments of IP address of the computer to the same values as the Controller and set only the right segment to a different value.

IP Address Setting Example

Device	Setting example
Sensor Controller	10.5.5.100 (default)
Computer	10.5.5.101

2 Open the Windows command prompt on the computer and execute the ping command.

At the ">" prompt, type "ping", followed by a space and the IP address of the Controller, and then press Enter.

Example:

```
C:\>ping 10.5.5.100
```

3 After a few seconds, if you see "Reply from" followed by the IP address of the Controller (e.g., 10.5.5.100), you will know that the Controller is connected to the Ethernet network.

Example:

```
Reply from 10.5.5.100: byte=32  
time<1ms TTL=128
```

If Anything Other than "Reply from" Is Displayed

This means that the Controller is not connected to the network for some reason. Check the following.

- Are the left three segments of the IP addresses of the computer and the Controller the same?
- Is the Ethernet cable connected?

4 Use the ping command to also check the communications status of the PLC.

After you have confirmed the communications status as described above, send an actual measurement command to the Controller and check to confirm that Vision Sensor communications are operating correctly.

Before Performing a Communications Test

This example assumes that [Serial (RS-232C/422)] – [PLC Link (SYSMAC CS/CJ/CP/One)] is selected as the Communications Module.

Stop the program on the PLC when you check the communications settings.

Checking the Communications Settings

Use the following procedure to check if the communications settings are correct.

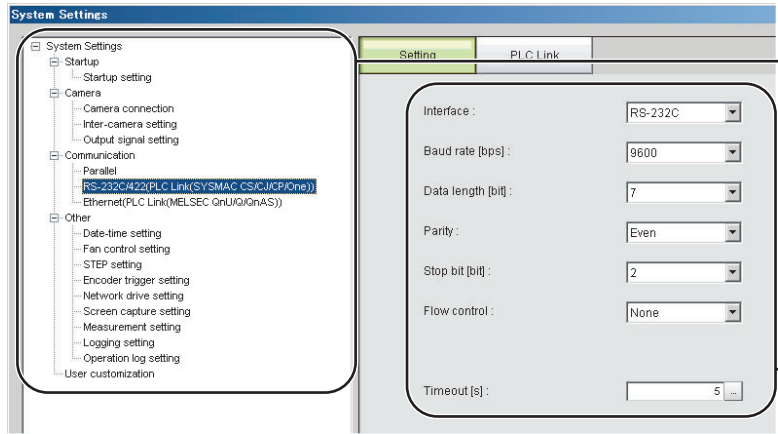

1. On the Main Window, select [Tool] – [System Settings]. Select [System data] from the tree on the left, and then select [Communication] – [RS-232C/422 (PLC Link (SYSMAC CS/CJ/CP/One))].

2. Set these settings based on the communications specifications.

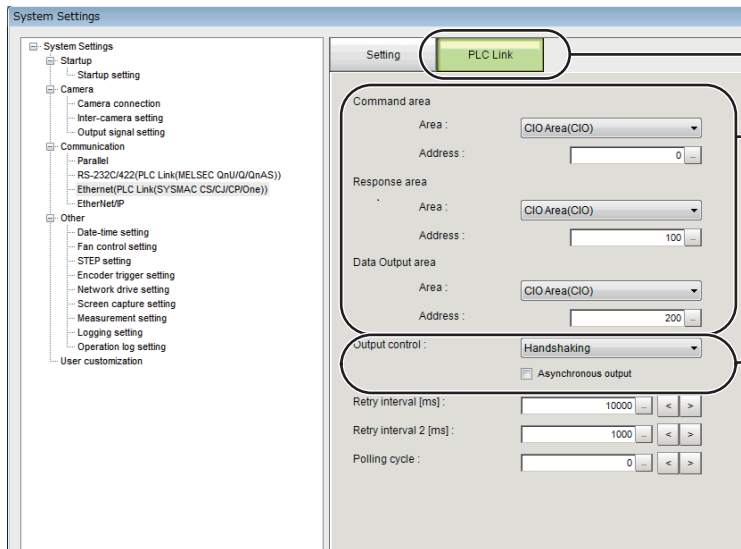

3. Click the [PLC Link settings] tab.

4. Set the area settings. Set these settings based on the connected PLC.

5. Set the output control. Set whether to provide an interlock with the PLC when performing data output.

6. This completes the Sensor Controller settings.

Checking the Communications Status

- 1** Connect the Sensor Controller and PLC Link with an RS-232C/422 cable.
- 2** If the cable is not connected, check to confirm that the message “PLC Link Error” is displayed on the Controller.
- 3** Confirm that the “PLC Link Error” message goes away when the cable is connected.
(At the longest, the message should disappear after the time set as the retry interval.)

If the “PLC Link Error” message does not go away, the PLC Link settings are not correct. Check the following.

- Are the communications settings correct for the connected device?
- Is the cable connected?
- Are all cables wired correctly?

After you have confirmed the communications status as described above, send an actual measurement command to the Controller and check to confirm that Vision Sensor communications are operating correctly.

Memory Allocation

This section explains allocations for each area including the Command Area, Response Area, and Data Output Area.

Command Area (PLC to Sensor Controller)

First word in Command Area	Bit																Name	
	15	14	13	12	11	10	9	8	7	6	5	4	3	2	1	0		
+0								XEXE									EXE	Control input (2 words)
+1																	DSA	
+2	CMD-CODE																(Command code: 2 words)	
+3																		
+4	CMD-PARAM																Command parameter (variable length)	
+5																		
+6																		
+7																		
+8																		
+9																		
+10																		
•																		
•																		
•																		

Signal	Signal name	Function
EXE	Command Request Bit	Executes a command. Reference: ► Command List (p.199)
DSA	Data Output Request Bit	Requests the next data output. Reference: ► Output Data Settings (Processing Item Registration) (p.184)
XEXE	Flow Command Request Bit	Executes a flow command.
CMD-CODE	Command code	Stores the command code.
CMD-PARAM	Command parameters	Stores command parameters.

Response Area (Sensor Controller to PLC)

Note

The order in which data is stored depends on the manufacturer of the connected PLC.
For details, see ► Reference: Parameter Notation Examples for Command Control (p.350).

First word in Response Area	Bit																Name
	15	14	13	12	11	10	9	8	7	6	5	4	3	2	1	0	
+0						XWAIT	XBUSY	XFLG							BUSY	FLG	Control input (2 words)
+1																GATE	
+2	CMD-CODE															(Command code: 2 words)	
+3																	
+4	RES-CODE															(Response code: 2 words)	
+5																	
+6	RES-DATA															Response data (length changeable)	
+7																	
+8																	
+9																	
+10																	
.																	
.																	
.																	

Signal	Signal name	Function
FLG	Command Completion Bit	Turns ON when command execution is completed.
GATE	Data Output Completion Bit	Turns ON when data output is complete.
BUSY	Command Busy Bit	Turns ON when command execution is in progress.
XFLG	Flow Command Completion Bit	Turns ON when flow command execution is complete.
XBUSY	Flow Command Busy Bit	Turns ON while a flow command is being executed.
XWAIT	Flow Command Wait Bit	Turns ON when a flow command can be executed.
CMD-CODE	Command code	Returns the executed command code.
RES-CODE	Response code	Stores the response from the executed command.
RES-DATA	Response data	Stores the response data from the executed command.

Data Output Area (Sensor Controller to PLC)

Data that is output to the Data Output Area is not automatically assigned.
Each data item for output is assigned in an Output Unit.

First word in the Data Output Area	Bit																Name
	15	14	13	12	11	10	9	8	7	6	5	4	3	2	1	0	
+0	DATA0																Output data 0
+1																	
+2	DATA1																Output data 1
+3																	
+4	DATA2																Output data 2
+5																	
+6	DATA3																Output data 3
+7																	
+8	DATA4																Output data 4
+9																	
+10	DATA5																Output data 5
+11																	
+12	DATA6																Output data 6
+13																	
+14	DATA7 ^{*1}																Output data 7

Signal	Signal name	Function
DATA0-7	Output data 0 to 7 ^{*1}	The data set in the output processing items is output. When there are multiple processing items, data is overwritten to this area while hand-shaking is performed.

*1: PLC Link allows up to 256 data items to be output at one time. Set the number of output data items for each Data Output processing item. By changing the default value for the number of output data items in the Data Output processing item from 8 to the maximum of 256, you can output up to DATA255.

Data storage in the PLC I/O memory depends on the connected PLC.

Refer to ► *Memory Display Image on PLC I/O* in the *Vision System FH/FZ5 Series User's Manual* (Cat. No. Z365).

I/O Signals

The following tables describes the signals that are used to control I/O for PLC Link communications.

Input Signals

Signal	Signal name	Function	ON/OFF timing	
			OFF to ON	ON to OFF
EXE	Command Request Signal	Turn ON this signal (from the PLC) to send a command to the Sensor Controller.	Turn ON the signal (from the PLC) to send a command to the Sensor Controller and request execution based on the command code and command parameters.	Turn OFF the signal from the PLC when the Sensor Controller turns ON the Command Completion (FLG) signal. ^{*1}
DSA (Used only for handshaking output control.)	Data Output Request Signal	This signal is to request to externally output that measurement data from the flow which was executed by the PLC at handshake time. If this signal is ON when an Output Unit (Data Output Unit) in the measurement flow is executed, the Sensor Controller will output the data from the processing item.	<ul style="list-style-type: none"> • Turn ON the signal (from the PLC) when you wish to output the data externally. • Turn ON the DSA signal at the same time as the Trigger (STEP) and Command Request (EXE) signals. If more than one Output Unit is used to output data, turn ON the DSA signal again after the GATE signals turns OFF. Reference: ► Time Charts (p.207)	Turn OFF the signal from the PLC when the Sensor Controller turns ON the Result Completion (GATE) signal. ^{*2}
XEXE	Flow Command Request Bit	Turn ON this signal to execute a command during execution of PLC Link flow control.	Turn ON the signal to request execution of a command that was input during execution of the PLC Link flow control.	Turn OFF the signal when the Flow Command Completion (XFLG) signal turns ON.

*1: A timeout error will occur and the Command Completion (FLG) signal and BUSY signal will be forced OFF if the EXE signal does not turn OFF within the time that is set in the PLC Link settings ([Retry interval] for Ethernet PLC Link and RS-232C/422 PLC Link) after the Command Completion (FLG) signal turns ON.

*2: A timeout error will occur and measurement data readied for output will be discarded if the DSA signal does not turn OFF within the time that is set in the PLC Link settings ([Retry interval] for Ethernet PLC Link and RS-232C/422 PLC Link) after the Result Completion (GATE) signal turns ON.

Output Signals

Signal	Signal name	Function	ON/OFF timing	
			OFF to ON	ON to OFF
BUSY	Busy Signal	<p>This signal tells when commands and other external inputs cannot be acknowledged. Make sure this signal is OFF before you request a command.</p> <p>Note:</p> <ul style="list-style-type: none"> The execution of commands or other processing received through any other protocol cannot be detected. (Example: This signal remains OFF during measurements for a parallel communications STEP signal.) If you use more than one protocol and need to detect command execution, use the parallel communications BUSY signal. Just because this signal is ON does not necessarily mean that a command is being executed. To check whether a command is being executed, access the Command Completion (FLG) signal. 	The FH/FZ5 turns ON the signal when it receives a command from the user (PLC). (The signal turns ON after the EXE signal turns ON.)	The signal turns OFF when the user (PLC) turns OFF the Command Request (EXE) signal.
FLG	Command Completion Signal	The FH/FZ5 uses this signal to tell the user (PLC) that command execution has been completed.	The signal turns ON when the FH/FZ5 completes execution of a received command.	The signal turns OFF when the user (PLC) turns OFF the Command Request (EXE) signal.

Signal	Signal name	Function	ON/OFF timing	
			OFF to ON	ON to OFF
GATE (Used only for handshaking output control.)	Data Output Completion Signal	<p>This signal tells the user (PLC) when to read the data output.</p> <p>This signal is ON: means that the data is output from Sensor Controller.</p> <p>Read the data (from the PLC) when this signal turns ON.</p>	<ul style="list-style-type: none"> The Result Set Request (DSA) signal turns ON after the FH/FZ5 executes the Output Unit (Data Output Unit) in the measurement flow^{*1}, preparations for data output have been completed, and the Result Set Request (DSA) signal is turned ON. *1: This occurs when the Output Unit is executed as the measurement flow is executed in order from the top. It does not occur when execution of a measurement is completed. If handshaking is disabled, the signal will always be OFF. 	The signal turns OFF when the user (PLC) turns OFF the Result Set Request (DSA) signal.
XFLG	Flow Command Completion Bit	This signal tells when execution of a command that was executed during execution of PLC Link flow control has been completed.	The signal turns ON when execution of a command that was executed during execution of PLC Link flow control has been completed (i.e., when Flow Command Busy turns OFF).	The signal turns OFF when the Flow Command Busy (XEXE) signal turns OFF.
XBUSY	Flow Command Busy Bit	This signal tells when a command that was input during execution of PLC Link flow control is being executed.	The signal is ON when a command that was input during execution of PLC Link flow control is being executed.	The signal turns OFF when the Flow Command Busy Bit (XEXE signal) turns OFF.
XWAIT	Flow Command Wait Bit	This signal tells when input of a command can be acknowledged during execution of PLC Link flow control.	The signal is ON when a command can be input during execution of PLC Link flow control.	The signal is OFF when a command cannot be input during execution of PLC Link flow control.

Output Items

Measurement Results That You Can Output with the Data Output Processing Item

You can use the processing items that are related to outputting results to output the following data. You can also access measured values from the Calculation or other processing units.

Measured item	Text string	Description
Judgement	JG	Judgement result
Data 0 to 255	D000 to D255	Results of expressions set for output data 0 to 255

External Reference Table for the Data Output Processing Item

By specifying a number, the following data can be referenced from control commands or processing items that have a set/get unit data function.

Number	Data name	Set/Get	Data range
0	Judgement	Get only	0: No judgement (unmeasured) 1: Judgement result OK -1: Judgement result NG
136	Communications method	Set/Get	0: Ethernet 1: RS-232C/RS-422
137	Output format	Set/Get	0: ASCII, 1: Binary
138	Digits of integer	Set/Get	1 to 10
139	Digits of decimal	Set/Get	0: 0 to 4:4
140	Minus	Set/Get	0: -, 1:8
141	Field separator	Set/Get	0: OFF, 1: Comma, 2: Tab, 3: Space, 4: Delimiter
142	Record separator	Set/Get	0: OFF, 1: Comma, 2: Tab, 3: Space, 4: Delimiter
143	0 suppress	Set/Get	0: No, 1: Yes
144 to 147	Output IP addresses 1 to 4 (only when Ethernet is selected for the communications method)	Set/Get	Destination IP addresses
149	Output IP Address Setting (only when Ethernet is selected for the communications method)	Set/Get	0: Reference to system, 1: Individual specification
150	Output form (decimal)	Set/Get	0: Fixed point, 1: Floating point
151	Offset	Set/Get	0 to 99999
152	Number of output data items (PLC Link only)	Set/Get	8 to 256
153	Plus	Set/Get	0: No, 1: +
1000 to 1255	Data 0 to Data 255	Get only	• ASCII: -99999999.999 to 999999999.999 • Binary: -2147483.648 to 2147483.647

Note

If you are using external reference numbers 5 to 12 on an FZ4 or earlier model, use 1000 to 1007 on the FH/FZ5.

Command List

The following tables list the commands used in PLC Link communications.

For command details, refer to ► Parameter Notation Examples for Command Control (p.350).

Execution Commands

First word in Command Area		Function	Reference
+3	+2		
0010	1010	Performs one measurement.	Reference: ► (p.361)
0010	1020	Starts continuous measurement.	Reference: ► (p.361)
0010	1030	Completes continuous measurement.	Reference: ► (p.362)
0010	1040	Executes a test measurement for the specified unit.	Reference: ► (p.362)
0010	2010	Clears measurement values.	Reference: ► (p.363)
0010	3010	Saves data in the Sensor Controller.	Reference: ► (p.364)
0010	4010	Re-registers the model data with the current image.	Reference: ► (p.365)
0010	5010	Shifts the image display position by the specified amount.	Reference: ► (p.366)
0010	5020	Zooms the image display in or out by the specified factor.	Reference: ► (p.366)
0010	5030	Returns the display position and display magnification to their default values.	Reference: ► (p.367)
0010	7010	Copies the scene data.	Reference: ► (p.368)
0010	7020	Deletes the scene data.	Reference: ► (p.368)
0010	7030	Stores the scene data.	Reference: ► (p.369)
0010	8010	Registers the specified image data as a registered image.	Reference: ► (p.370)
0010	8020	Loads the specified registered data as a measurement image.	Reference: ► (p.370)
0010	9010	Responds in the first word of the Response Area +6+7 with the data that was set in first word of the Command Area +4+5.	Reference: ► (p.371)
0010	A010	Adds a user account to a specified group ID.	Reference: ► (p.372)
0010	A020	Deletes a specified user account.	Reference: ► (p.373)
0010	B010	Branches to the start of the measurement flow (processing unit 0).	Reference: ► (p.373)
0010	F010	Restarts the Sensor Controller.	Reference: ► (p.374)

Commands to Get Status

First word in Command Area		Function	Reference
+3	+2		
0020	1000	Gets scene number.	Reference: ► (p.374)
0020	2000	Gets the scene group number.	Reference: ► (p.375)
0020	4000	Gets the number of the layout that is currently displayed.	Reference: ► (p.376)
0020	5010	Gets the number of the unit that is currently displayed in the specified Image Display Pane.	Reference: ► (p.376)
0020	5020	Gets the subimage number for the specified Image Display Pane.	Reference: ► (p.377)
0020	5030	Gets the image mode for the specified Image Display Pane.	Reference: ► (p.378)

First word in Command Area		Function	Reference
+3	+2		
0020	7010	Gets the input status (enabled/disabled) for the Communications Modules.	Reference:▶ (p.378)
0020	7020	Gets the output status (enabled/disabled) to external devices.	Reference:▶ (p.379)
0020	8010	Gets the ON/OFF status of the specified parallel I/O terminal.	Reference:▶ (p.380)
0020	8020	Gets the ON/OFF status of all parallel terminals except for DI terminals.	Reference:▶ (p.381)
0020	8030	Gets the ON/OFF status of all parallel DI terminals.	Reference:▶ (p.385)
0020	9000	Gets the user name for the currently logged in user account.	Reference:▶ (p.388)
0020	9010	Gets the affiliation group ID for the currently logged in user account.	Reference:▶ (p.388)
0020	A000	Gets the current state of the operation log.	Reference:▶ (p.389)

Commands to Set Status

First word in Command Area		Function	Reference
+3	+2		
0030	1000	Changes the scene.	Reference:▶ (p.390)
0030	2000	Switches the scene group number.	Reference:▶ (p.390)
0030	4000	Sets the layout number and changes the image.	Reference:▶ (p.391)
0030	5010	Sets the number of the Unit to display in the specified Image Display Pane.	Reference:▶ (p.392)
0030	5020	Sets the number of the subimage to display in the specified Image Display Pane.	Reference:▶ (p.392)
0030	5030	Sets the image mode for the specified Image Display Pane.	Reference:▶ (p.393)
0030	7010	Enables/disables inputs to the Communications Modules.	Reference:▶ (p.394)
0030	7020	Enables/disables outputs to external devices.	Reference:▶ (p.394)
0030	8010	Sets the ON/OFF status of the specified parallel I/O terminal.	Reference:▶ (p.395)
0030	8020	Sets the ON/OFF status of all parallel terminals, except for DO terminals.	Reference:▶ (p.397)
0030	8030	Sets the ON/OFF status of all parallel DO terminals.	Reference:▶ (p.401)
0030	9000	Changes the user account used by the user currently logging in.	Reference:▶ (p.403)
0030	A000	Sets the state of the operation log.	Reference:▶ (p.404)

Commands to Read Data

First word in Command Area		Function	Reference
+3	+2		
0040	1000	Gets the unit data.	Reference:▶ (p.405)
0040	2000	Gets the current date and time.	Reference:▶ (p.405)
0040	3000	Gets system version information.	Reference:▶ (p.406)
0040	4000	Gets settings related to image logging.	Reference:▶ (p.407)
0040	4010	Gets the defined image logging folder name.	Reference:▶ (p.408)
0040	4020	Gets the defined data logging folder name.	Reference:▶ (p.409)
0040	4030	Gets the defined screen capture folder name.	Reference:▶ (p.409)

First word in Command Area		Function	Reference
+3	+2		
0040	4040	Gets the set image logging prefix	Reference:▶ (p.410)
0040	4050	Gets the conditions that are set for data logging.	Reference:▶ (p.410)
0040	4060	Gets the parallel DI terminal offset data that is set.	Reference:▶ (p.411)

Commands to Write Data

First word in Command Area		Function	Reference
+3	+2		
0050	1000	Sets the unit data.	Reference:▶ (p.412)
0050	2000	Sets the date/time.	Reference:▶ (p.413)
0050	4000	Changes settings related to image logging.	Reference:▶ (p.414)
0050	4010	Set the image logging file folder name.	Reference:▶ (p.415)
0050	4020	Sets the data logging folder name.	Reference:▶ (p.415)
0050	4030	Sets the screen capture folder name.	Reference:▶ (p.416)
0050	4040	Sets the image logging prefix.	Reference:▶ (p.416)
0050	4050	Sets the data logging conditions.	Reference:▶ (p.417)
0050	4060	Sets the parallel DI terminal offset data.	Reference:▶ (p.417)

File Load Commands

First word in Command Area		Function	Reference
+3	+2		
0060	1000	Loads the scene data.	Reference:▶ (p.418)
0060	2000	Loads the scene group data.	Reference:▶ (p.419)
0060	3000	Loads system data.	Reference:▶ (p.419)
0060	5000	Loads System + Scene group 0 data.	Reference:▶ (p.420)

File Save Commands

First word in Command Area		Function	Reference
+3	+2		
0070	1000	Saves the scene data.	Reference:▶ (p.421)
0070	2000	Saves the scene group data.	Reference:▶ (p.421)
0070	3000	Saves system data.	Reference:▶ (p.422)
0070	4000	Saves the image data.	Reference:▶ (p.423)
0070	4010	Saves all the image data in the image buffer (specified with [main unit logging image]).	Reference:▶ (p.423)
0070	4020	Saves the last logging image.	Reference:▶ (p.424)
0070	5000	Saves System + Scene Group 0 data in a file.	Reference:▶ (p.424)
0070	6000	Captures the screen.	Reference:▶ (p.425)

Command Response Processing

The ON/OFF timing of related signals from command input in control command response processing is indicated in the timing chart below.

Timing Chart for Command Execution

The commands for measurement execution or other processing that are stored in advance in the memory of the PLC are input and executed when you turn ON the Command Request (EXE) signal.

The Command Completion (FLG) signal turns ON when execution of the control command is completed. Use this as the trigger to turn OFF the Command Request (EXE) signal.

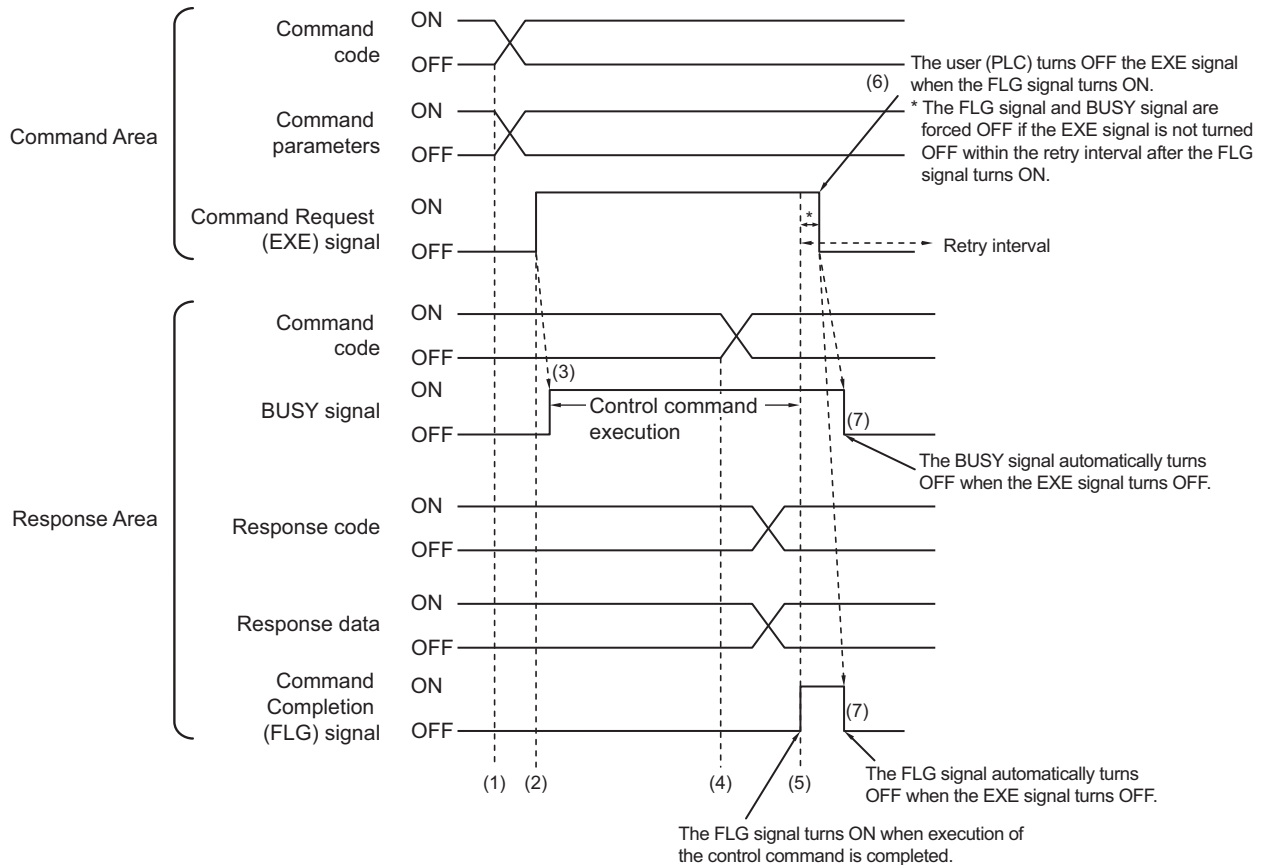

- 1** The command code and command parameters are set from the PLC.
- 2** Next, confirm that the BUSY signal and the Command Completion (FLG) signal have turned OFF and then turn ON the Command Request (EXE) signal again. A request is sent to the Sensor Controller.
- 3** The Sensor Controller executes the command and turns ON the BUSY signal when the request is received.
- 4** When the Sensor Controller finishes execution of the command, the command code, response code, and response data are set.
- 5** The Command Completion (FLG) signal is then turned ON.
- 6** The PLC (user) turns OFF the Command Request (EXE) signal when the Command Completion (FLG) signal turns ON.
- 7** When the Sensor Controller detects that the Command Request (EXE) signal is OFF, it automatically turns OFF the Command Completion (FLG) signal and the BUSY signal.

*1: A timeout error occurs and the Command Completion (FLG) signal and BUSY signal are forced OFF if the Command Request (EXE) signal is not turned OFF from the PLC (user) within the time set in the PLC Link settings ([Retry interval]: 0 to 999999 ms for Ethernet PLC Link, or [Timeout]: 1 to 120 s for RS-232C/422-PLC Link).

Timing Chart for the Execution of Continuous Measurement Commands without Handshaking

Continuous execution is used to repeatedly execute measurements by starting the next measurement operation (image input and measurement processing) as soon as one measurement operation (image input and measurement processing) is completed.

Continuous measurements are started when the Start Continuous Measurements command is executed and ended when the End Continuous Measurements command is executed.

The BUSY signal remains OFF during continuous measurement, but in this state the Sensor Controller can receive the End Continuous Measurements command.

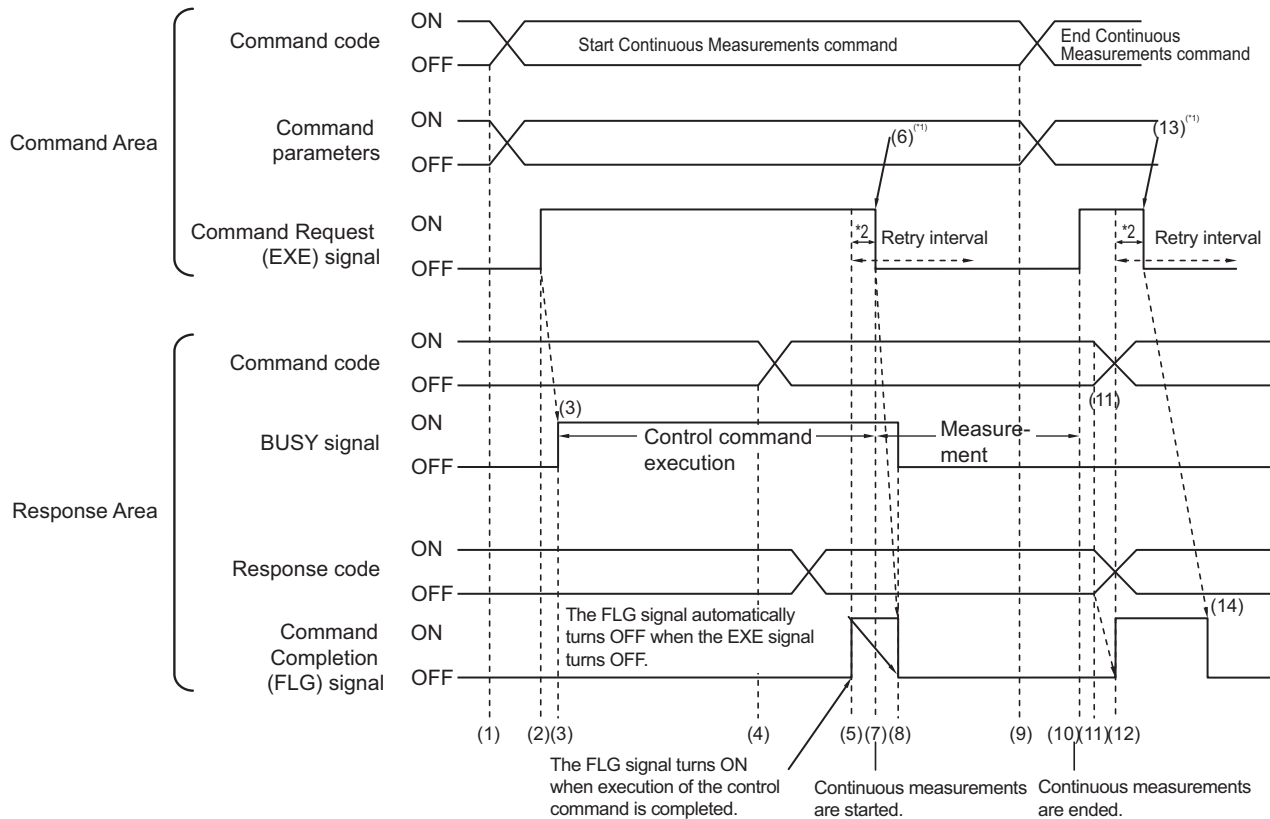

*1: The user (PLC) turns OFF the EXE signal when the FLG signal turns ON.

*2: The FLG signal and BUSY signal are forced OFF if the EXE signal is not turned OFF within the retry interval after the FLG signal turns ON.

Operation to Start Continuous Measurements

- 1** The Start Continuous Measurements command code is set from the PLC (user).
- 2** The Command Request (EXE) signal is then turned ON. A request is sent to the Vision Sensor.
- 3** The Sensor Controller begins preparing for continuous measurement and turns ON the BUSY signal when the request is received.
- 4** The Sensor Controller sets the command code and response code when preparations for continuous measurement have been completed.
- 5** The Command Completion (FLG) signal is then turned ON.
- 6** The PLC (user) turns OFF the Command Request (EXE) signal when the Command Completion (FLG) signal turns ON.
- 7** When the Sensor Controller detects that the Command Request (EXE) signal has turned OFF, it starts continuous measurements.
- 8** The Command Completion (FLG) signal and the BUSY signal are then turned OFF automatically.

*1: A timeout error occurs and the Command Completion (FLG) signal and BUSY signal are forced OFF if the Command Request (EXE) signal is not turned OFF from the PLC (user) within the time set in the PLC Link settings ([Retry interval]: 0 to 999999 ms for Ethernet PLC Link, or [Timeout]: 1 to 120 s for RS-232C/422-PLC Link).

Operation to End Continuous Measurements

- 9** The Stop Continuous Measurements command code is set from the PLC (user).
- 10** The Command Request (EXE) signal is then turned ON. A request is sent to the Sensor Controller and continuous measurements are stopped.

Note

Continuous measurements are not ended in the middle of a measurement. When the End Continuous Measurements command is executed, continuous measurements are ended after the measurement that is currently being executed is completed.

• Ending Continuous Measurements

- 11** The Sensor Controller sets the command code and response code when continuous measurement is stopped.
- 12** The Command Completion (FLG) signal is then turned ON.
- 13** The PLC (user) turns OFF the Command Request (EXE) signal when the Command Completion (FLG) signal turns ON.
- 14** When the Sensor Controller detects that the Command Request (EXE) signal is OFF, it automatically turns OFF the Command Completion (FLG) signal.

IMPORTANT

- The measurements during continuous measurements are given priority. Therefore, display of the measurement results (overall judgment, images, judgment for each processing unit in the flow display, and detailed results) may sometimes not be updated.
 - When continuous measurements are ended, the measurement results from the last measurement will be displayed.
-

Data Output

The ON/OFF timing of signals related to data output after completion of measurement is indicated in the timing chart below.

No Handshaking

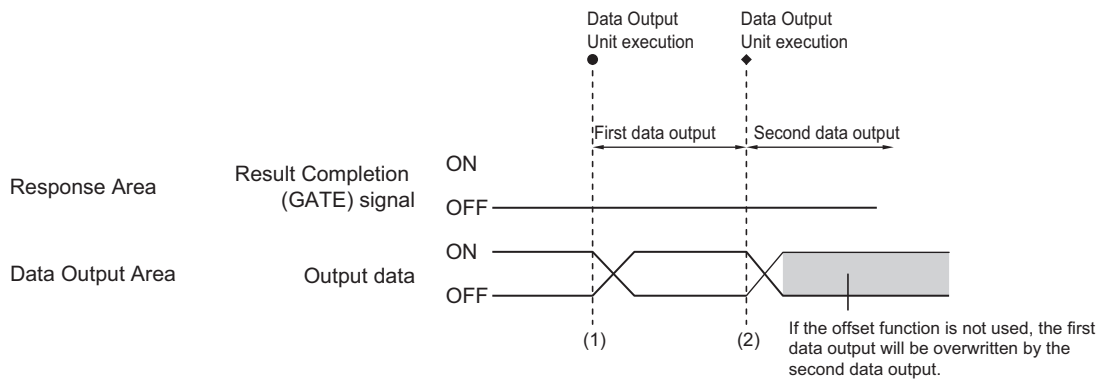

- 1** The Sensor Controller outputs data when execution of the Data Output Unit is started.
- 2** Data is output every time the Data Output Unit or another Data Output Unit is executed. The previously output data is overwritten. Therefore, you should use a PLC Link offset when executing multiple Data Output Units without handshaking.

Reference: ► Output Format (Data Output) (p.188)

Using Handshaking

When the PLC (user) turns ON the Result Set Request (DSA) signal, the Result Completion (GATE) signal turns ON.

At that point, the output data that can be output*1 is output.

The PLC (user) turns OFF the DSA signal when it has received the output data and when the Result Completion (GATE) signal is ON.

If data is output from more than one Data Output Unit, turn ON the DSA signal again after the Sensor Controller turns OFF the Result Completion (GATE) signal to output the next output data.

*1: This is the data that is prepared for output when the Output Unit is executed in the measurement flow.

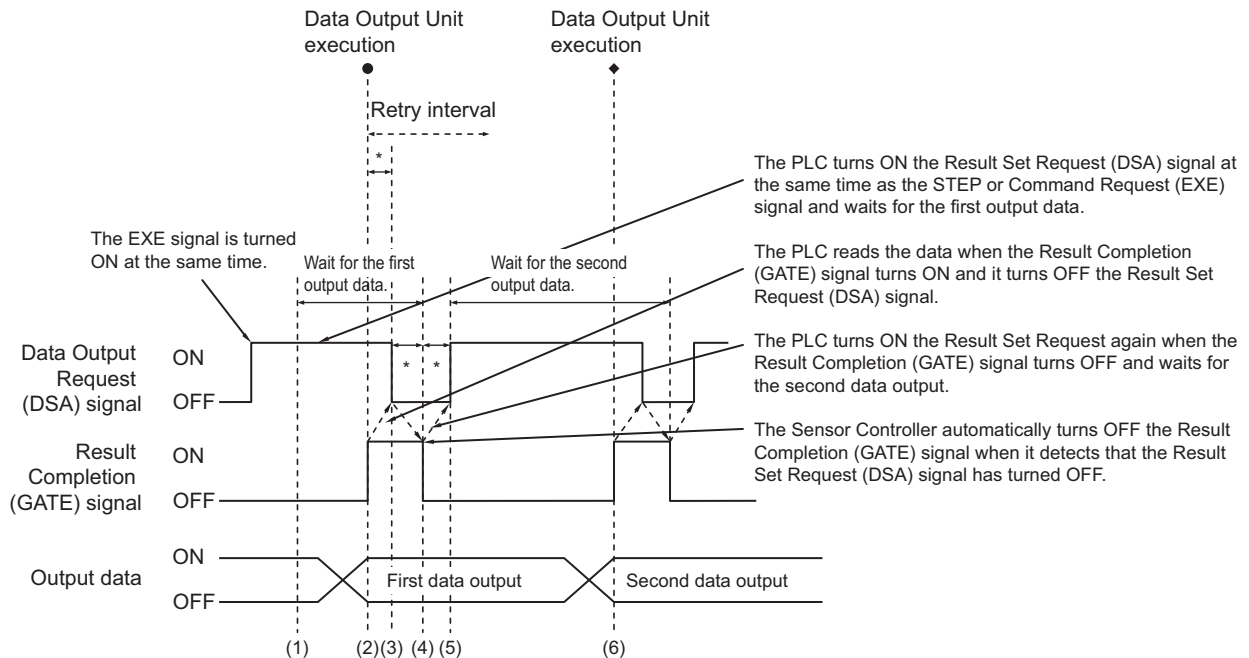

*1: A timeout error will occur if the following states persist longer than the time set in the PLC Link settings ([Retry interval] for Ethernet PLC Link, or [Timeout] for RS-232C/422 PLC Link).

- If the DSA signal is not turned ON after a certain time elapses from when measurement is finished. (Turn ON the DSA signal at the same time as the measurement trigger command.)
- If the DSA signal is not turned OFF after a certain time elapses from when the GATE signal turns ON.
- If the DSA signal is not turned ON after a certain time elapses from when the GATE signal turns OFF.

- 1** The PLC (user) turns ON the Command Request (EXE) signal and the Result Set Request (DSA) signal at the same time. The output data for the first Data Output Unit can be dependably received.
- 2** The Sensor Controller executes the Data Output Unit in the measurement flow. Because the Result Set Request (DSA) signal is ON, the Result Completion (GATE) signal turns ON and the output data from the Data Output Unit is output to the external device.
- 3** The PLC (user) reads the data when the Result Completion (GATE) signal turns ON and it turns OFF the Result Set Request (DSA) signal.
- 4** The Sensor Controller automatically turns OFF the Result Completion (GATE) signal when it detects that the Result Set Request (DSA) signal has turned OFF.
- 5** If there is more than one Data Output Unit in the measurement flow, the PLC (user) turns ON the Result Set Request (DSA) signal when the Result Completion (GATE) signal turns OFF and then waits for execution of the next Data Output Unit.
- 6** When the next Data Output Unit is executed, the GATE signal turns ON and the data is output. Receive the second output data and then repeat steps 3 to 5, above. Repeat steps 3 to 5 for any other data outputs.

Time Charts

The ON/OFF timing of signals related to the sequence of operation from control command input until data output after completion of measurement is indicated in the timing chart below.

Example 1: Inputting a Measurement Command after Changing a Scene without Handshaking

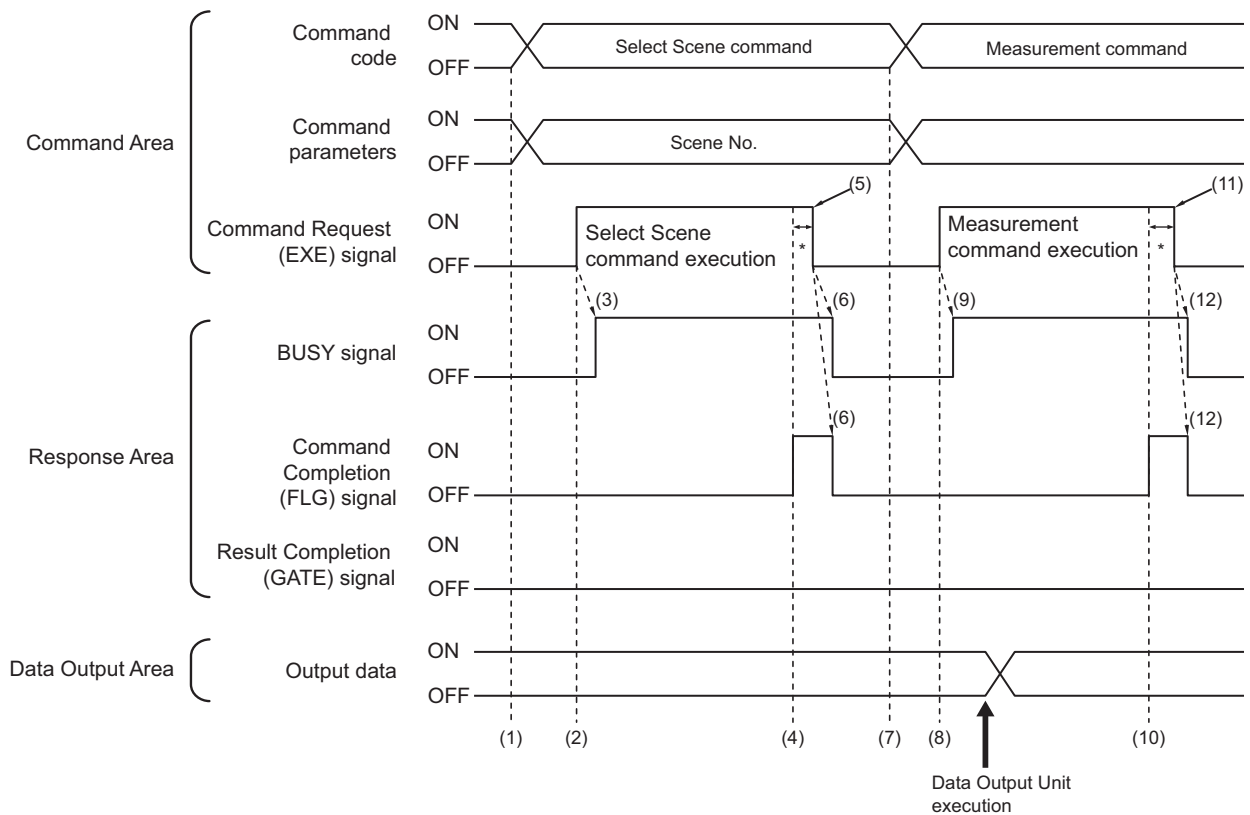

- 1** The command code and command parameters for the Select Scene command are set from the PLC.
- 2** Next, confirm that the BUSY signal and the Command Completion (FLG) signal have turned OFF and then turn ON the Command Request (EXE) signal again. A request is sent to the Sensor Controller.
- 3** The Sensor Controller changes the scene and turns ON the BUSY signal when the request is received.
- 4** The Command Completion (FLG) signal is turned ON.
- 5** The PLC (user) turns OFF the Command Request (EXE) signal when the Command Completion (FLG) signal turns ON.
- 6** When the Sensor Controller detects that the Command Request (EXE) signal is OFF, it automatically turns OFF the Command Completion (FLG) signal and the BUSY signal.
- 7** The measurement command code and command parameters are set from the PLC.
- 8** The Command Request (EXE) signal is turned ON to execute the measurement command.

Note

To execute a measurement trigger after changing the scene, first confirm that the Command Completion (FLG) signal and the BUSY signal that turned ON for execution of the Select Scene command have turned OFF. Also, if the BUSY signal is ON for too little time and the external device cannot read it, increase the time that the BUSY signal is ON for changing scenes so that the external device can read the ON state. To do this, change the [Add time] setting for the [Scene switch time]. Refer to ► *Setting the Conditions That Are Related to Operation during Measurement* in the *Vision System FH/FZ5 Series User's Manual* (Cat. No. Z365).

- 9** The Sensor Controller executes measurement processing and turns ON the BUSY signal when the request is received.
- 10** The Command Completion (FLG) signal is turned ON.
- 11** The PLC (user) turns OFF the Command Request (EXE) signal when the Command Completion (FLG) signal turns ON.
- 12** When the Sensor Controller detects that the Command Request (EXE) signal is OFF, it automatically turns OFF the Command Completion (FLG) signal and the BUSY signal.

*1: A timeout error occurs and the Command Completion (FLG) signal and BUSY signal are forced OFF if the Command Request (EXE) signal is not turned OFF from the PLC (user) within the time set in the PLC Link settings ([Retry interval] for Ethernet PLC Link and RS-232C/422 PLC Link).

Example 2: Outputting Data with More Than One Output Unit without Handshaking

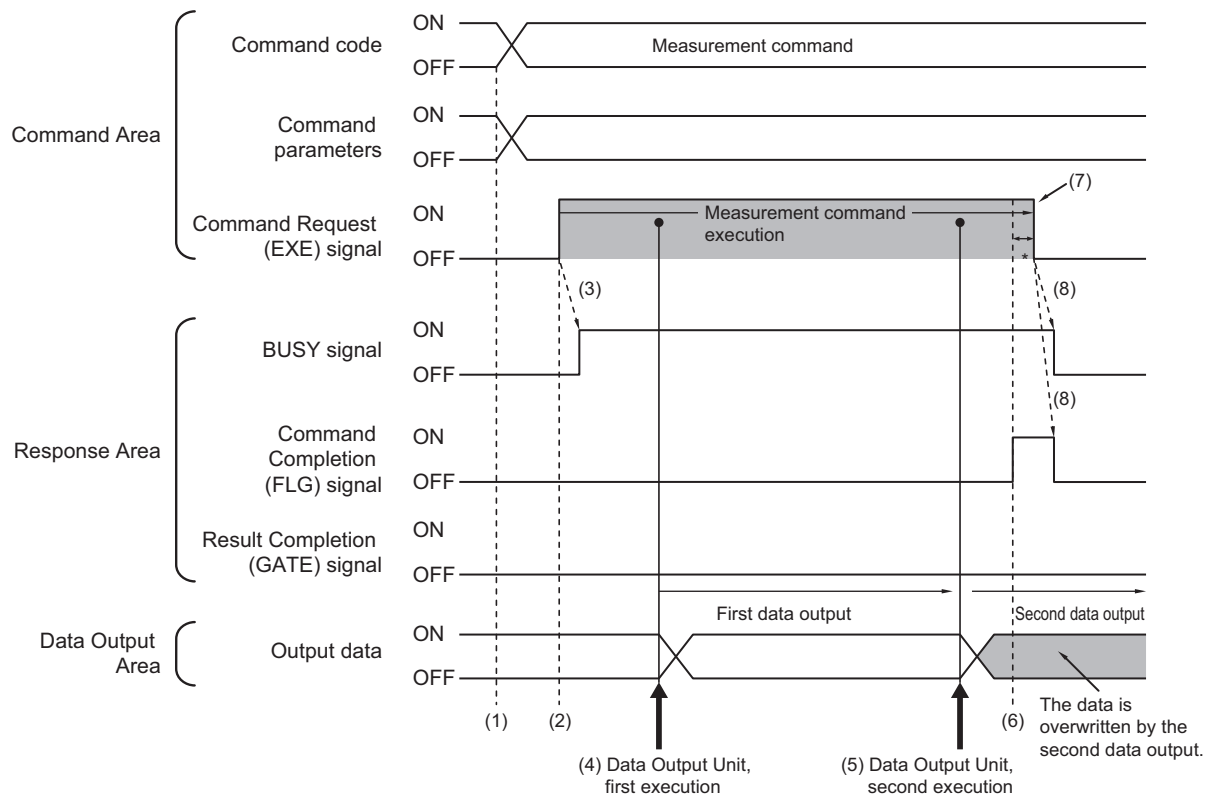

- 1** The measurement command code and command parameters are set from the PLC.
- 2** Next, confirm that the BUSY signal and the Command Completion (FLG) signal have turned OFF and then turn ON the Command Request (EXE) signal again. A request is sent to the Sensor Controller.
- 3** The Sensor Controller executes measurement processing and turns ON the BUSY signal when the request is received.
- 4** When the first Data Output Unit in the measurement flow is executed, the output data for the first Data Output Unit is output to the position at the specified offset in the Data Output Area.
- 5** When the second Data Output Unit in the measurement flow is executed, the output data for the second Data Output Unit is output to the position at the specified offset in the Data Output Area.

*1: If no offset has been set, the data will overwrite the data from the first Data Output Unit in the same Data Output Area.

- 6** The Command Completion (FLG) signal is turned ON.
- 7** The PLC (user) turns OFF the Command Request (EXE) signal when the Command Completion (FLG) signal turns ON.
- 8** When the Sensor Controller detects that the Command Request (EXE) signal is OFF, it automatically turns OFF the Command Completion (FLG) signal and the BUSY signal.

*1: A timeout error occurs and the Command Completion (FLG) signal and BUSY signal are forced OFF if the Command Request (EXE) signal is not turned OFF from the PLC (user) within the time set in the PLC Link settings ([Retry interval] for Ethernet PLC Link, or [Timeout] for RS-232C/422-PLC Link).

Note

Saving All of the Measurement Results

If you output data from more than one Data Output Unit or for repeatedly measured output data (e.g., for continuous measurements), the same Data Output Area will be overwritten.

If you want to save all output data, use one of the following methods.

Method	Description
Offset (PLC Link Communications Only)	When using more than one Output Unit, you can offset the write destination of the output data for each Output Unit. Set the [Offset] for the Data Output processing item. Reference: Output Format (Data Output) (p.188) This function is enabled when you are performing data output from more than one Data Output Unit.
Controlling Data Output with Handshaking	Handshaking lets you control data output by using the GATE signal turning ON as a trigger for the data output timing and by turning ON the DSA signal to read the output data. Each time that data is output (from the second output on), read the output data and move it to a different part of I/O memory in the PLC. Reference: ► Data Output Control with Handshaking (p.32)

You can compare the received number of output data and the number of measurements for continuous measurements to check if all of the measurement results have been received.

Use the following method to check the number of measurements that was actually executed.

- Application Example

Set a calculation to count the number of measurements that are executed in the measurement flow.

If you set something like [DO+1], each time a measurement is executed (each time the measurement flow is executed), 1 will be added to DO, so the present value of DO will give you the actual number of measurements.

PLC Link Troubleshooting

Cannot Input to the Sensor Controller (RS-232C/422 Only)

Problem	Cause	Action
No response is received after sending communications commands.	There is a problem with the wiring.	Check the wiring. Check the cable connections.
	There is a problem with the RS-232C settings.	Make sure that the settings are correct.
Responses are no longer received after sending communications commands (but communications were working previously).	You are attempting to send commands while the BUSY signal is still ON.	Send commands only when the BUSY signal is OFF.
	A cable has been disconnected.	Check the cable connections.
	A connector has been disconnected.	Check the connector connections.

No Data Is Output from the Sensor Controller

Problem	Cause	Action
The GATE signal does not turn ON.	Handshaking is disabled. The GATE signal is not output when there is no handshaking for the PLC Link protocol.	Enable handshaking for the output control in the communications settings.
	The DSA signal is not ON (when handshaking is enabled).	Turn ON the DSA signal from the PLC.

Problem		Cause	Action
There is absolutely no data output.	Ethernet	The output IP address is incorrect.	Set the output IP address correctly.
	RS-232C/422	There is a problem with the wiring or a cable has been disconnected.	Check the wiring. Check the cable connections.
		A connector has been disconnected.	Check the connector connections.
		You have not added any Data Output processing items in the measurement flow.	You have not added any Data Output processing items in the measurement flow.
	The [Output] option is not selected in the Adjustment Window.	Select the [Output] option in the Adjustment Window.	
Data is sometimes output, but sometimes not.	Ethernet	The measurement commands are not being received.	If the BUSY signal stays OFF after sending a measurement command, the measurement command may not have been received. Send measurement commands only when the BUSY and FLG signals are both OFF.
	RS-232C/422	A cable has been disconnected.	Check the cable connections.
		The [Output] option is not selected in the Adjustment Window.	Select the [Output] option in the Adjustment Window.
	The measurement commands are not being received.	If the BUSY signal stays OFF after sending a measurement command, the measurement command may not have been received. Send measurement commands only when the BUSY and FLG signals are both OFF.	
The read/Verification string is not output.	Character output have not been set.	Set character output in the output parameters for the character output processing items (Character Inspection, Barcode, 2DCode, etc.). (Output for read/target strings is set up in the above processing items, not in the Data Output processing items.)	
There is more than one Data Output Item, but data is received from only the last Data Output Unit in the list.	The data output by the first Data Output Unit is being overwritten by the data output by a Data Output Unit executed afterwards.	Use handshaking to control the data output or use an offset to prevent this from happening.	

A Timeout Error Occurred

Problem	Cause	Action
A handshaking timeout error occurred.	The DSA signal is being turned ON and OFF too slowly. The following patterns are possible. <ul style="list-style-type: none"> The DSA signal does not turn ON after a measurement is completed. The DSA signal does not turn OFF after the GATE signal turns ON. The DSA signal does not turn ON after the GATE signal turns OFF. 	Turn the DSA signal ON or OFF within the time interval set for the timeout time.
	The DSA signal is not being output or the Sensor Controller is slow in recognizing that the DSA signal has turned ON.	Check the timing of the DSA signal output in the PLC program. The signal may not be received correctly due to noise.

Slow Operation

Problem	Cause	Action
It takes around 10 seconds to execute any PLC Link commands.	Communications are timing out.	Set the PLC cycle time to the shortest interval possible.
Response and data output is slow.	You are performing communications with incompatible protocols (e.g., PLC Link and EtherNet/IP).	Do not use incompatible protocols for communications.
	Asynchronous output is selected without output control.	If you select asynchronous output, set the output control to [Handshaking]. If you specify no output control, do not select asynchronous output.

A PLC Link Error Occurred

Problem	Cause	Action
The message "PLC Link Error" is displayed.	You are performing communications with incompatible protocols (e.g., PLC Link and EtherNet/IP).	Do not use incompatible protocols for communications.
	You changed the communications settings on the PLC (i.e., the port settings).	Restart the PLC.

Communicating with EtherNet/IP

This section describes the required communication settings, communication specifications, input/output format, and communication timing chart for communication between the Sensor Controller and external devices by EtherNet/IP.

Introduction to EtherNet/IP

EtherNet/IP is an industrial multi-vendor network that uses Ethernet.

The EtherNet/IP specifications are open standards managed by the ODVA (Open DeviceNet Vendor Association). EtherNet/IP is used by a wide range of industrial devices.

Because EtherNet/IP uses standard Ethernet technology, various general-purpose Ethernet devices can be used in the network.

EtherNet/IP has mainly the following features.

High-speed, High-capacity Data Exchange through Tag Data Links

The EtherNet/IP protocol supports implicit communications, which allows cyclic communications called tag data links with EtherNet/IP devices.

Tag Data Links at Specified Communications Cycle for Each Application Regardless of the Number of Nodes

Tag data links (cyclic communications) operate at the cyclic period that is specified for each application, regardless of the number of nodes. Data is exchanged over the network at the refresh cycle that is set for each connection. The communications refresh cycle will not increase even if the number of nodes is increased, i.e., the concurrency of the connection's data is maintained.

Because the refresh cycle can be set for each connection, each application can communicate at its ideal refresh cycle. For example, interprocess interlocks can be transferred at high speed, while the production commands and the status monitor information are transferred at low speed.

IMPORTANT

- On a network to which many devices are connected, performance may drop (e.g., responses may be delayed or packets lost) or communications errors may occur when there is temporarily high traffic on the network. Test the operation under actual conditions before you start actual operation of the system.
- Since a reasonable amount of measurement takt time is required to have stable communications in an operation under high load, verify the operation under the conditions that are to be actually applied.
- Use Ethernet connector 2 (the bottom connector) to perform EtherNet/IP communications with the following series:
 - FH-1000 series (4 and 8 camera type)
 - FH-3000 series (4 and 8 camera type)

You cannot use EtherNet/IP communications with Ethernet connector 1 (the top connector).

- Connection using Multi-line Random Trigger Mode is not possible with some PLCs. In Multi-line Random Trigger Mode, the sensor controller assigns a connection to each line. On some PLCs, multiple connections cannot be set. Check and verify the PLC specifications prior to using.

Data Exchange with EtherNet/IP

Communications with Tag Data Links

Data is exchanged cyclically between Ethernet devices on the EtherNet/IP network using tag data links as shown below.

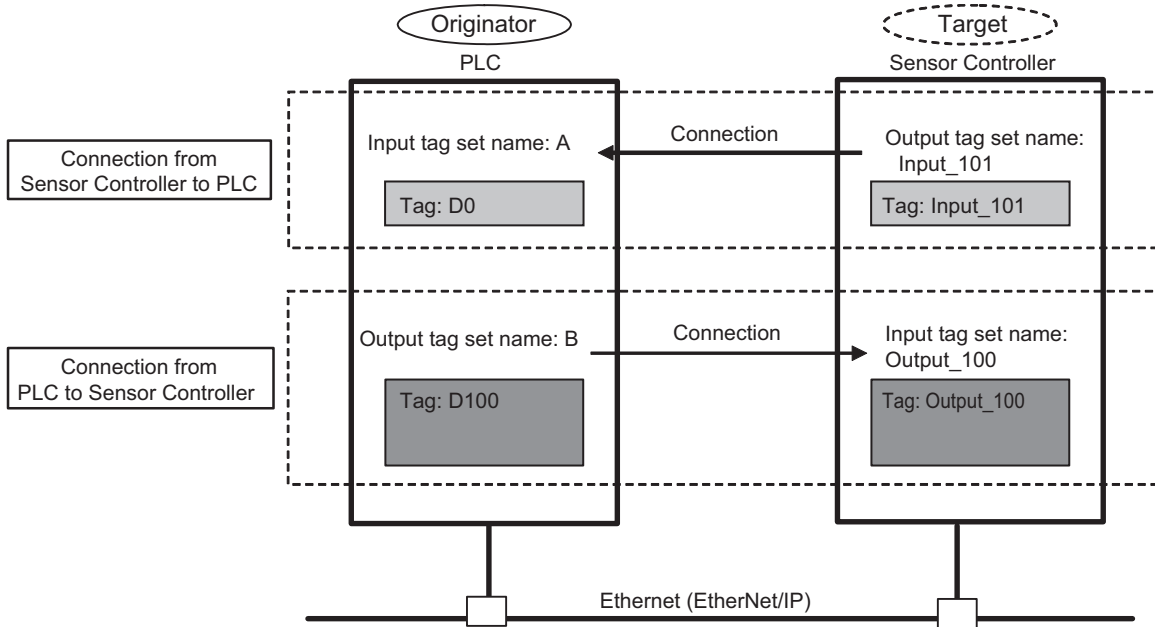

Data Exchange Method

To exchange data, a connection is opened between two EtherNet/IP devices.

One of the nodes requests the connection to open a connection with a remote node.

The node that requests the connection is called the originator, and the node that receives the request is called the target.

Data Exchange Memory Locations

The memory locations that are used to exchange data across a connection are specified as tags.

You can specify memory addresses or variables for tags.

A group of tags consists of an output tag set and an input tag set.

Note

Message communications are used when communicating with a PLC that does not support tag data link communications or when using functions, such as character string output, that are not supported in tag data link communications. If you are using EtherNet/IP message communications, refer to ► Communicating with the Sensor Controller with EtherNet/IP Message Communications (p.264).

EtherNet/IP Communications Cycle (RPI)

Data is refreshed for EtherNet/IP tag data link communications at a communications interval called the RPI (requested packet interval).

All data transfer between the external device (e.g., PLC) and the Sensor Controller are performed at the set RPI.

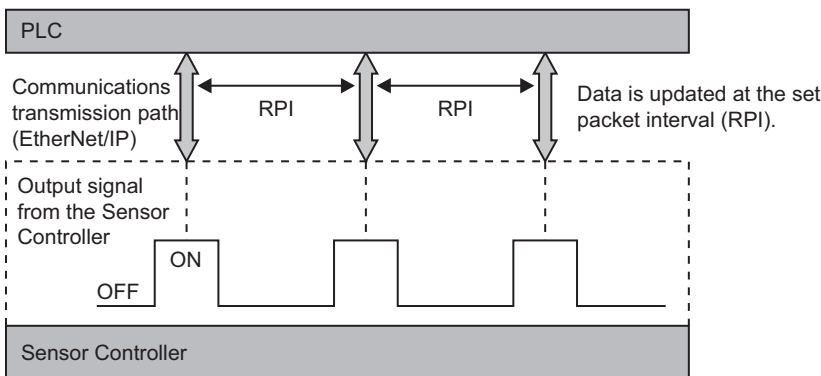

Signal changes from the Sensor Controller are affected by the RPI. In some cases the target device may not detect a change in the ON/OFF status of a signal depending on the RPI timing.

Therefore, you must set up the RPI and output signals from the Sensor Controller so that they satisfy the following relationship:

$$\text{Duration of change in Sensor Controller signal} > \text{RPI}$$

IMPORTANT

Set the RPI to 4 ms or higher.

If the RPI is longer than the duration of a Sensor Controller signal change, the signal change may not be detected.

Example 1: Duration of Change in Sensor Controller Signal < RPI

RPI		30 ms
Sensor Controller	Output period	50 ms
	Output time	30 ms (ON: 30 ms, OFF: 20 ms)
	Output control	None

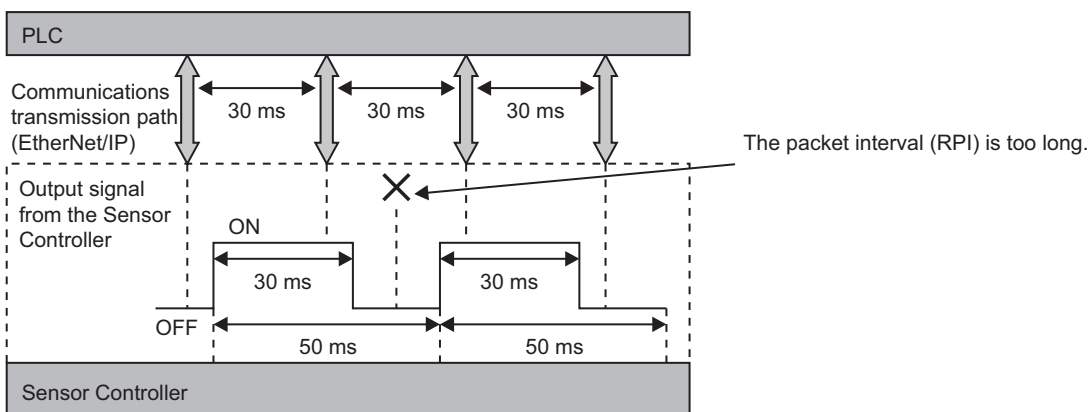

The PLC cannot detect some of the output signals from the Sensor Controller.

Example 2: Duration of Change in Sensor Controller Signal > RPI

RPI		10 ms
Sensor Controller	Output period	50 ms
	Output time	30 ms (ON: 30 ms, OFF: 20 ms)
	Output control	None

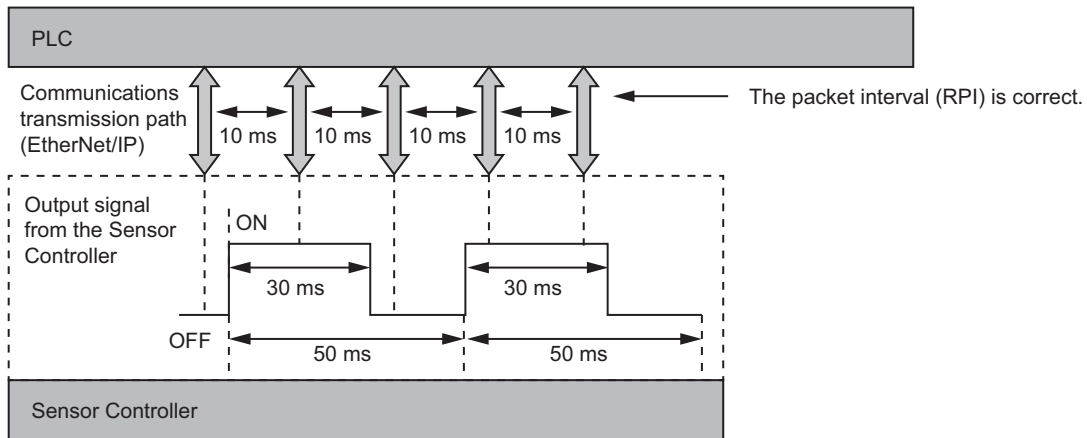

The RPI is shorter than the shortest signal time (GATE OFF: 20 ms), so the PLC can detect all output signals from the Sensor Controller.

Note

Set the communications settings as follows:

- Sensor Controller communications settings: Set [Output period] and [Output time] in the EtherNet/IP settings.
Reference: ► Set the EtherNet/IP Output Specifications (p.225)
- RPI setting: Set the RPI using Support Software that can set tag data link settings (e.g., Network Configurator).
Reference: ► Tag Data Link Setting Methods (p.228)

EtherNet/IP Communications

You can use an EtherNet/IP tag data link to communicate between the PLC and the Sensor Controller to control the Sensor Controller from the PLC with command/response communications or to output data after measurements.

The Sensor Controller supports EtherNet/IP conformance tests.

Tag data link settings are set using Support Software for tag data link settings.

To connect to OMRON Controllers and communicate through EtherNet/IP, you use the Network Configurator to set up tag data links (i.e., tags, tag sets, and connection settings).

This section describes how to use the Network Configurator to set tag data link settings.

Refer to the following manuals for details on the tag data link settings that are made with the Network Configurator.

- Reference: ► *NJ-series CPU Unit Built-in EtherNet/IP Port User's Manual* (Cat. No. W506)
- Reference: ► *CS/CJ-series EtherNet/IP Units Operation Manual* (Cat. No. W465)
- Reference: ► *CJ-series EtherNet/IP Units Operation Manual for NJ-series CPU Unit* (Cat. No. W495)

IMPORTANT

- Since a reasonable amount of measurement takt time is required to have stable communications in an operation under high load, verify the operation under the conditions that are to be actually applied.
- On a network to which many devices are connected, performance may drop (e.g., responses may be delayed or packets lost) or communications errors may occur when there is temporarily high traffic on the network. Test the operation under actual conditions before you start actual operation of the system.
- When the measurement interval is short, the measurement processing load is high, or command processing for operations such as scene group changing is time-consuming, the Sensor Controller prioritizes measurement processing and control processing over communication processing. As a result, communication between an external device and the Sensor Controller may be temporarily interrupted, and a communication error may occur. In this case, set the communication error timeout time longer than the Sensor Controller's processing time, or lengthen the measurement interval. Set the communication error timeout time in the tag data link connection settings^{*1} as follows:
Timeout value > Measurement time on Sensor Controller.

*1: Use Support Software, such as the Network Configurator, to change the tag data link connection settings. For information on setting the tag data links using the Network Configurator, refer to ► Tag Data Link Setting Methods (p.228).

Communications Processing Flow

For EtherNet/IP communications, the following five communications areas are set in the PLC to perform communications.

Input tag set to the Sensor Controller	(1) Command Area (command/response method)	You write the control commands to execute for the Sensor Controller to this area.
	(2) User Input Area	You write data that you define for the FH Sensor Controller to this area.
Output connection to PLC	(3) Response Area (command/response method)	The FH Sensor Controller writes the results of executing the control commands that were written in the Command Area to this area.
	(4) Data Output Area (data output after measurement)	The FH Sensor Controller writes the output data for the measurement to this area after execution of the measurement.
	(5) User Output Area	The FH Sensor Controller writes data that you define to this area.

The above five areas are set using Support Software that can set tag data link settings (e.g., Sysmac Studio Ver. 1.10 or later, Network Configurator). The areas can be specified by using I/O memory addresses or variable names.

For details on tag data link settings using the Network Configurator, refer to ► Tag Data Link Setting Methods (p.228). Or, if you are connecting to a non-OMRON PLC or EtherNet/IP unit, download the EDS file for the Sensor Controller from your OMRON website and follow the procedures in the user's manual for the external device you want to connect to and in the instructions for the software that you use to set the tag data link settings. The flow of EtherNet/IP communication between a PLC and the Sensor Controller is shown below.

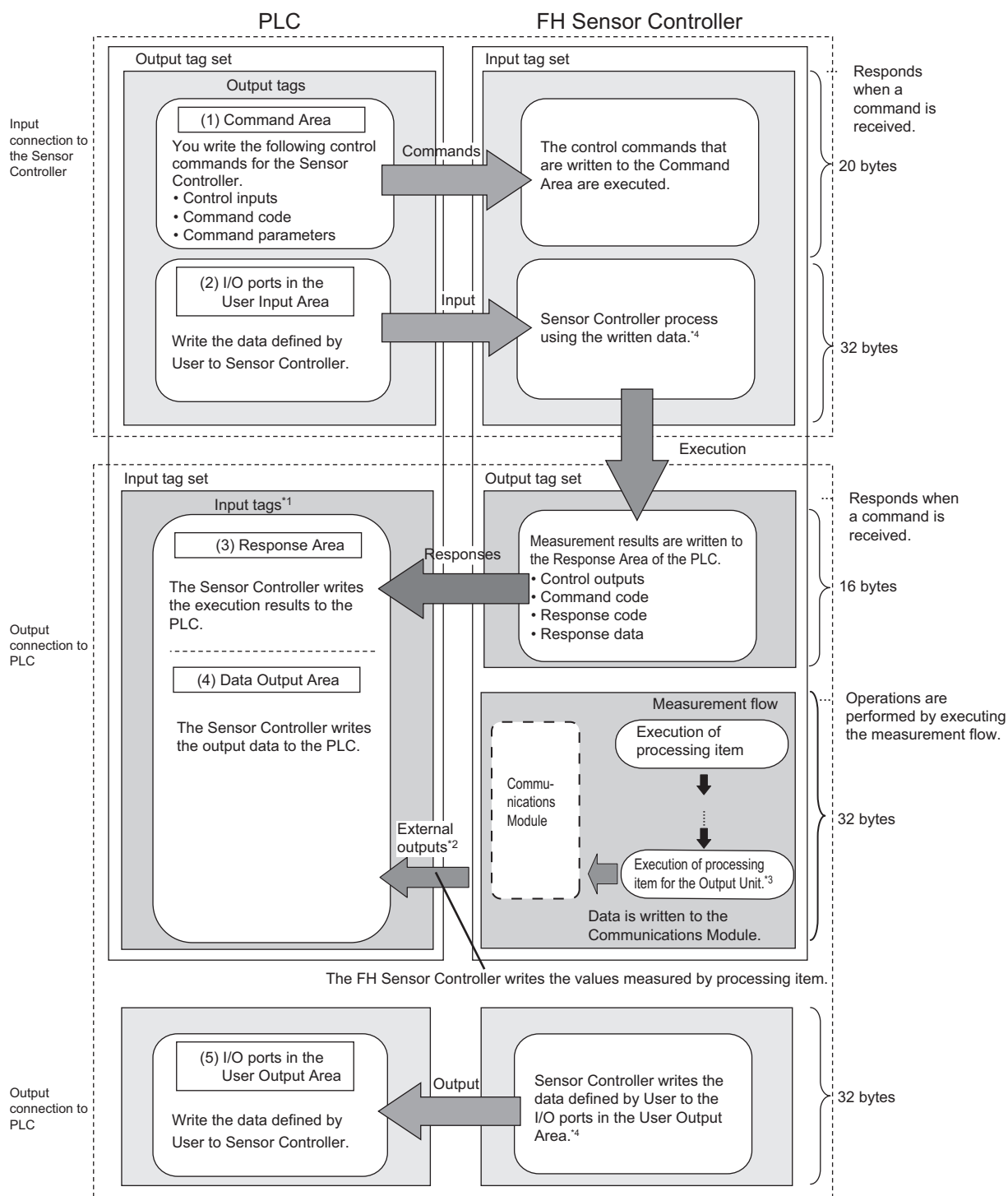

*1: The Response Area (3) and Data Output Area (4) are assigned to continuous memory addresses or to variables.

*2: You can use output controls (handshaking) to prevent output data from being externally output from the communications buffer until the Controller (master) turns ON the DSA signal to request the output data.

*3: Refer to ► Settings Required for Data Output (p.29) for information on the Output Units that output measurement data.

*4: Use the Macro Customization Function to input and output to the User Area.
For the Macro Customization Function, refer to ► EtherNet/IP communication of the IO Module List in the Vision System FH/FZ5 Macro Customize Functions Programming Manual (Cat. No. Z367).

Communications Setup Procedures

The following settings are required to use EtherNet/IP communications.

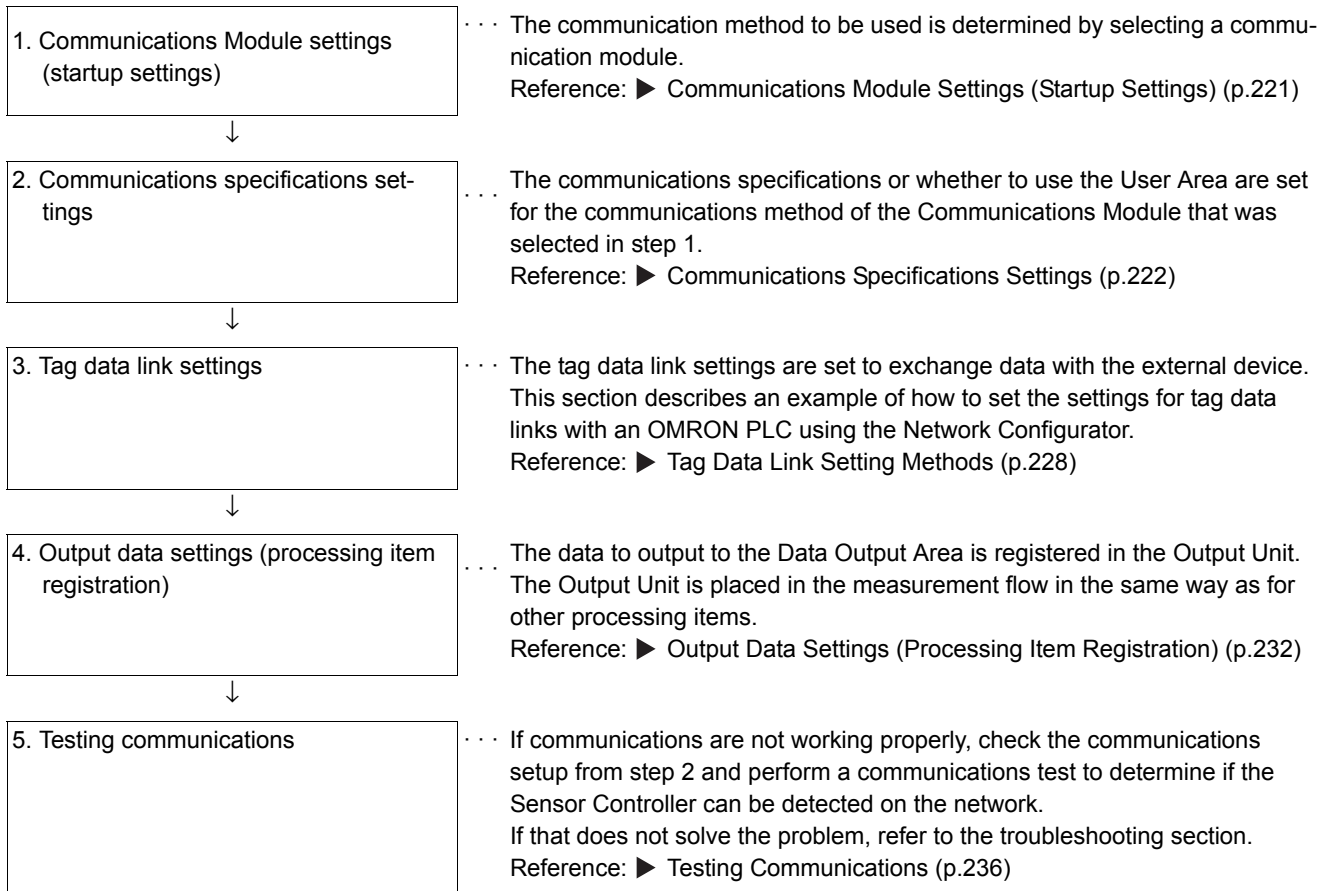

Communications Module Settings (Startup Settings)

The communication method used for communication with the Sensor Controller is selected from the communication modules.

- 1 On the Main Window, select [Tool] – [System Settings].
- 2 Select [System settings] – [Startup] – [Startup setting] on the Multiview Explorer on the left and then click [Communication].

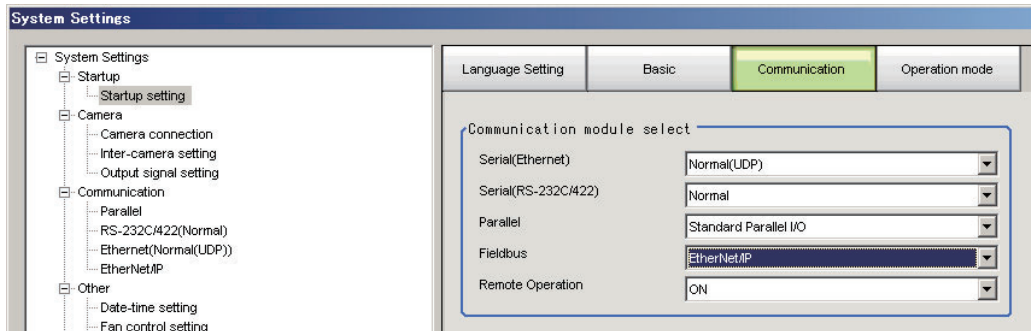

- 3 In the Communication module select Area, select [EtherNet/IP] in the [Fieldbus] box and then click [Apply].
- 4 Click the [Data save] button in the Toolbar.

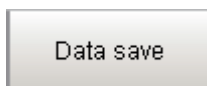

- 5 On the Main Window, select [Function] – [System restart].
Click [OK] in the [System restart] dialog box to restart the Sensor Controller.
- 6 When the Sensor Controller has been restarted, operation will be performed for the default settings of the specified Communications Module.
Set the IP address and other settings for the PLC or other external device.

IMPORTANT

After you set the Communications Module, always click [Data save] and then restart the Sensor Controller. If the settings are not saved and the Sensor Controller is not restarted, the new Communications Module settings will not be enabled.

Note

You can save the Communications Module settings to a file.
Select [Save to file] from the [Function] menu, and then select [System data] or [System + Scene group 0 data] to save the settings data to a file.
Refer to ► *Saving Settings Data to the Controller RAM Disk or an External Memory Device* in the *Vision System FH/FZ5 Series User's Manual* (Cat. No. Z365).

Communications Specifications Settings

You must set the output handshaking and output controls for EtherNet/IP communications.

IMPORTANT

- Set the Communications Module to EtherNet/IP in the startup settings before setting the communications specifications. Reference: ► Communications Module Settings (Startup Settings) (p.62)
After you select the Communications Module, save the settings to the Sensor Controller and restart the Sensor Controller. If you do not restart the Sensor Controller, the selected Communications Module will not be enabled. Furthermore, if the operation mode is set to the Multi-line Random Trigger Mode, the Communications Modules for lines 1 and higher must also be set to EtherNet/IP.
- When using Multi-line Random-trigger Mode, specify different addresses for the sending and receiving areas for each line.
- After the tag data link is set, the Sensor Controller automatically restarts to reflect the setting.

Setting IP Addresses

Use the following procedure to set the IP address of the Sensor Controller.

- 1 On the Main Window, select [Tool] – [System Settings].**
- 2 In the tree view on the left, select [System Settings] – [Communication] – [Ethernet Normal (xyz)]. (“xyz” depends on the Communications Module.)**
The Ethernet View is displayed.
- 3 Set up the following items.**

UDP

The screenshot displays the communication settings interface for the Sensor Controller, organized into three distinct sections:

- Address setting 1:** This section is for the first communication module. It features a radio button for "Obtain an IP address automatically" (which is unselected) and a checked radio button for "Use the following IP address". Below this, there are input fields for IP address (10.5.5.100), Subnet mask (255.255.255.0), Default gateway (10.5.5.100), DNS server (10.5.5.100), Preferred WINS server (0.0.0.0), and Alternate WINS server (0.0.0.0).
- Address setting 2:** This section is for the second communication module. It has the same layout as Address setting 1, with the "Use the following IP address" option selected. The IP address is set to 10.5.6.100, and the Default gateway is 10.5.6.100.
- Input/Output setting:** This section configures the communication parameters. "Input mode" is set to "Normal" and "Input form" is set to "ASCII". The "Output IP address" is 0.0.0.0, "Input port No." is 9600, and "Output port No." is -1, with a note that -1 means "Same number input port No".

Note

-
- The following series with 4 or 8 camera inputs has two Ethernet ports:

- FH-1000 series
- FH-3000 series

Set the settings for the two Ethernet ports as follows:

- Communications Module settings
Use the same setting for both ports.

- IP address settings

Set a different IP address for each Ethernet port.

The IP address for the top Ethernet port is set in [Address setting], and the IP address for the bottom Ethernet port is set in [Address setting 2]. Note that the top Ethernet port on the FH does not support EtherNet/IP communication. By using both Ethernet ports simultaneously, you can use the bottom port for PLC Link, non-procedure, Ethernet, or IP communications with a PLC and the top port for FTP or remote operation communications with an external device.

- The following Sensor Controller type has one Ethernet port:

FH-L series

FH-1000/FH-3000 series with two camera inputs

In this case, the IP address of the Ethernet port is set in [Address setting 2].

- The FZ5 has only one Ethernet port.

In this case, the IP address of the Ethernet port is set in the [Address setting].

Setting item	Set value [Factory default]	Description
Address Settings Address Settings is only for the following series: <ul style="list-style-type: none"> • FH-1000 series (4, 8 camera type) • FH-3000 series (4, 8 camera type) • FZ5 series Sensor Controller 		Set the IP address of the top Ethernet port on the Sensor Controller.
	<ul style="list-style-type: none"> • Obtain an IP address automatically • [Use the following IP address] 	Set the IP address of the Sensor Controller. When [Obtain an IP address automatically] is selected, the IP address of the Sensor Controller will be automatically obtained. When [Use the following IP address] is selected, set the IP address, subnet mask, and the default gateway address.
IP address	a.b.c.d a: 1 to 223 b: 0 to 255 c: 0 to 255 d: 2 to 254 [10.5.5.100]	Input the IP address of the Sensor Controller.
Subnet mask	0.0.0.0 to 255.255.255.255 [255.255.255.0]	Input the subnet mask address.
Default gateway	a.b.c.d a: 1 to 223 b: 0 to 255 c: 0 to 255 d: 0 to 255 [10.5.5.100]	Input the default gateway address.
DNS server	a.b.c.d a: 1 to 223 b: 0 to 255 c: 0 to 255 d: 0 to 255 [10.5.5.100]	Input the DNS server address.
Preferred WINS server	a.b.c.d a: 1 to 223 b: 0 to 255 c: 0 to 255 d: 0 to 255 [0.0.0.0]	Inputs address of WINS server.
Alternate WINS server	a.b.c.d a: 1 to 223 b: 0 to 255 c: 0 to 255 d: 0 to 255 [0.0.0.0]	Inputs address of WINS server.

Setting item	Set value [Factory default]	Description	
Address setting 2 Address Settings is only for the following series: • FH-1000 series (2 camera type) • FH-3000 series (2 camera type) • FH-L series Sensor Controller		Set the IP address of the bottom Ethernet port on the Sensor Controller.	
• Obtain an IP address automatically • [Use the following IP address]			
IP address	a.b.c.d a: 1 to 223 b: 0 to 255 c: 0 to 255 d: 2 to 254 [10.5.6.100]		
Subnet mask	0.0.0.0 to 255.255.255.255 [255.255.255.0]		
Default gateway	a.b.c.d a: 1 to 223 b: 0 to 255 c: 0 to 255 d: 0 to 255 [10.5.6.100]		Same as [Address setting].
DNS server	a.b.c.d a: 1 to 223 b: 0 to 255 c: 0 to 255 d: 2 to 255 [10.5.6.100]		
Preferred WINS server	a.b.c.d a: 1 to 223 b: 0 to 255 c: 0 to 255 d: 0 to 255 [0.0.0.0.]		Inputs address of WINS server.
Alternate WINS server	a.b.c.d a: 1 to 223 b: 0 to 255 c: 0 to 255 d: 0 to 255 [0.0.0.0]	Inputs address of WINS server.	

4 Click [Apply] to apply the settings.

Click [Close] to close the System Settings Dialog Box .

IMPORTANT

Change the IP address and subnet mask for [Address setting] and [Address setting 2] as required so that each designate a different network address. If the same network address is specified, communications may not be performed correctly.

Set the EtherNet/IP Output Specifications

1 On the Main Window, select [Tool] – [System Settings].

2 Select [System Settings] and then select [Communication] – [EtherNet/IP].

The Ethernet View is displayed.

3 Set the following items.

The screenshot shows a 'Setting' window with the following fields:

- Output control: Handshaking (dropdown menu)
- Output period [ms]: 10.0 (text input)
- Output time [ms]: 5.0 (text input)
- Timeout [s]: 10.0 (text input)
- Output data size: Result Data Format 0(32byte) (dropdown menu)
- User Area: OFF (checkbox)

Setting item	Set value [Factory default]	Description
Output control	<ul style="list-style-type: none"> • None • [Handshaking] 	<p>Set whether to synchronize with the external device when data is output.</p> <p>None: The Sensor Controller outputs measurement results without synchronizing with external devices. Normally, select [Handshaking]. Reference: ► No Handshaking (p.258)</p> <p>Handshaking: The Sensor Controller outputs measurement results while synchronized with external devices. Reference: ► Using Handshaking (p.259)</p>
Output period	<ul style="list-style-type: none"> • 2.0 to 5000.0 ms • [10.0 ms] 	<p>Valid only when [Output control] is set to [None]. Set the cycle by which measurement results are output.</p> <ul style="list-style-type: none"> • Set the cycle so that the interval is longer than the output time, but less than the measurement interval. • Adjust this value based on the RPI (packet interval) communications cycle in the EtherNet/IP connection settings of the PLC you want to connect to. <p>Reference: ► EtherNet/IP Communications Cycle (RPI) (p.215)</p>
Output time	<ul style="list-style-type: none"> • 1.0 to 1000.0 ms • [5.0 ms] 	<p>Valid only when [Output control] is set to [None]. Set the GATE signal ON time. Set the time required for external devices to acquire measurement results. Adjust this value based on the RPI (packet interval) communications cycle in the EtherNet/IP connection settings of the PLC you want to connect to.</p> <p>Reference: ► EtherNet/IP Communications Cycle (RPI) (p.215)</p>
Timeout [s]	<ul style="list-style-type: none"> • 0.5 to 120.0 s • [10.0 s] 	<p>Valid only when [Output control] is set to [Handshaking]. A timeout error occurs when no response from external devices is received within the time that has been set. A timeout error occurs when no response from external devices is received within the time that has been set. Also, a timeout error occurs if the status of each signal does not change within the specified time in the following situations.</p> <ul style="list-style-type: none"> • If the DSA signal is not turned ON after a certain time elapses from when measurements are finished • The DSA signal turns OFF after the GATE flag turns ON. • The DSA signal turns ON after the GATE flag turns OFF.
Output data size	<ul style="list-style-type: none"> • [Result Data Format 0 (32byte)] • Result Data Format 1 (64byte) • Result Data Format 2 (128byte) • Result Data Format 3 (256byte) 	<p>Set the size of output data for each line.</p> <p>There are four type of data size: 32 bytes, 64 bytes, 128 bytes, and 256 bytes.</p> <p>Result Data Format 0 (32byte): Output data 0 to 7 of 4 bytes can be use and total size of the output data is 32 bytes.</p> <p>Result Data Format 1 (64byte): Output data 0 to 15 of 4 bytes can be use and total size of the output data is 64 bytes.</p> <p>Result Data Format 2 (128byte): Output data 0 to 31 of 4 bytes can be use and total size of the output data is 128 bytes.</p> <p>Result Data Format 3 (256byte): Output data 0 to 63 of 4 bytes can be use and total size of the output data is 256 bytes.</p>

Setting item	Set value [Factory default]	Description
User area	<ul style="list-style-type: none"> • [OFF] • ON 	Set whether to use the User Area that are user input area and user output area. <ul style="list-style-type: none"> • Data type of User Input Area 0 to 3 is DINT. • Data type of User Input Area 4 to 5 is LREAL. • Data type of User Output Area 0 to 3 is DINT. • Data type of User Output Area 4 to 5 is LREAL.

IMPORTANT

About Output data size and User Area

All line's Output data size and User Area are necessary to be equal when you select the Multi-line random trigger in Operation mode.

4 Click [Apply] to apply the settings.

Click [Close] to close the System Settings Dialog Box.

IMPORTANT

PLC Connection Timeout Interval

Set the PLC connection timeout interval so that it is longer than the measurement processing time. For the timeout value, refer to the IMPORTANT section on p.217.

Tag Data Link Setting Methods

This section describes how to set data links for EtherNet/IP.

The communications areas in the PLC for which data links are created to the Sensor are specified as tags and tag sets, and the connections are set for tag data link communications.

To connect to OMRON Controllers and communicate through EtherNet/IP, you use the Sysmac Studio Ver. 1.10 or later, Network Configurator to set up tag data links (i.e., tags, tag sets, and connection settings).

The procedures to set up the tag data link using the Network Configurator are described here.

Refer to the following manuals for details on the tag data link settings that are made with the Network Configurator.

- Reference: ► *NJ-series CPU Unit Built-in EtherNet/IP Port User's Manual* (Cat. No. W506)
- Reference: ► *CS/CJ-series EtherNet/IP Units Operation Manual* (Cat. No. W465)
- Reference: ► *CJ-series EtherNet/IP Units Operation Manual for NJ-series CPU Unit* (Cat. No. W495)

IMPORTANT

- When connecting to an NJ-series or CJ-series CPU Unit, install the EDS file that defines the connection information for the Sensor Controller to the Support Software (e.g., Network Configurator). Download the EDS file from OMRON's website.
- After the tag data links are set, the Vision Sensor is automatically restarted to apply the settings.

Tags, Tag Sets, and Connection Settings

The communications areas in the PLC are set as tag data link connections as shown in the following table.

• Tag and Tag Set Settings in the PLC

Parameter	Settings	
	Command Area	Response Area and Output Area
Type of tags and tag set	Output tag set	Input tag set
Tag and tag set names	I/O memory addresses or variable names	I/O memory addresses or variable names ^{*1}
Data size	Total size which Command area size and User Input area size. <ul style="list-style-type: none"> • 20 bytes (When you do not use the User area) • 52 bytes (When you use the User area) 	Total size which Response area, Data output area and User Output area. <ul style="list-style-type: none"> • When you select Result Data Format 0 in the Data output number. <ul style="list-style-type: none"> • 48 bytes (When you do not use the User area) • 80 bytes (When you use the User area) • When you select Result Data Format 1 in the Data output number. <ul style="list-style-type: none"> • 80 bytes (When you do not use the User area) • 112 bytes (When you use the User area) • When you select Result Data Format 2 in the Data output number. <ul style="list-style-type: none"> • 144 bytes (When you do not use the User area) • 176 bytes (When you use the User area) • When you select Result Data Format 3 in the Data output number. <ul style="list-style-type: none"> • 272 bytes (When you do not use the User area) • 304 bytes (When you use the User area)

*1: Specify the I/O memory address of the first word in the Response Area. The Output Area is assigned immediately after the Response Area. If you specify a variable name, the variable is assigned for both the Response Area and Output Area. Refer to ► Accessing Communications Areas Using Variables with NJ-series Controllers (p.243) for information on how to access the signals in the communications areas from the user program when variables are assigned.

Settings in the Sensor Controller (Device Parameter Settings)

- 1 Right-click the Sensor Controller in the network on the Network Configurator and select [Parameter] – [Edit].
- 2 The Edit Device Parameters Dialog Box will be displayed. Make the required settings.

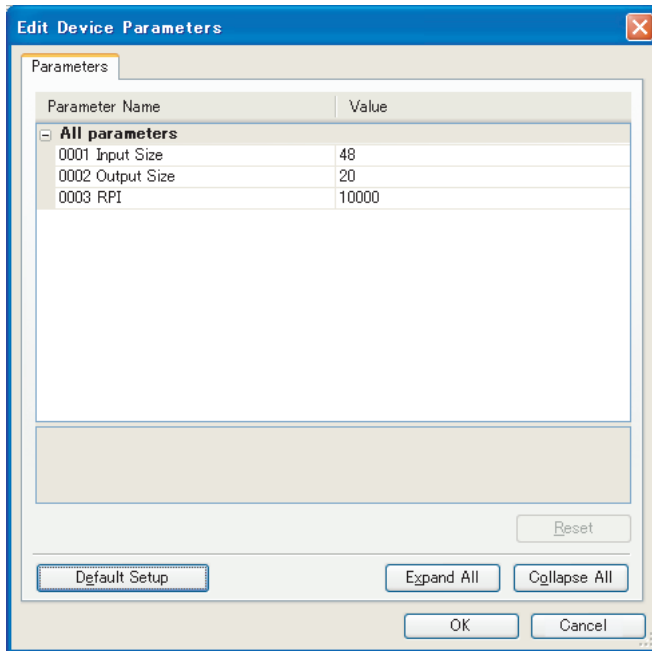

Parameter name	Value	Set value
001 Input Size ^{*1}	Total size of Response Area, Data Output Area, and User Input Area.	Set one of the following values. When [Result Data Format 0] is selected under Output data size: 48 bytes (without using the user area) 80 bytes (with using the user area) When [Result Data Format 1] is selected under Output data size: 80 bytes (without using the user area) 112 bytes (with using the user area) When [Result Data Format 2] is selected under Output data size: 144 bytes (without using the user area) 176 bytes (with using the user area) When [Result Data Format 3] is selected under Output data size: 272 bytes (without using the user area) 304 bytes (with using the user area)
002 Output Size ^{*2}	Total size of Command Area and User Input Area.	Set either of the following values. 20 bytes (without using the user area) 52 bytes (with using the user area)
003 RPI ^{*3}	The requested packet interval	10000

*1: Although the data size can be set as high as 502 bytes, use the above settings.

*2: Although the data size can be set as high as 502 bytes, use the above settings.

*3: The packet interval (RPI) is set in the connection settings between the PLC and the Sensor. No setting is required here.

Connection Settings

Parameter		Setting
Originator device (PLC)	Input tag set	<i>PLC_tag_set_name</i> -[48Byte] *1
	Connection type	Any (default: Point to Point connection)
	Output tag set	<i>PLC_tag_set_name</i> -[20Byte] *1
Target device (Sensor Controller)	Output tag set	Input_101-[48Byte]*1
	Input tag set	Output_100-[20Byte] *1
Packet interval (RPI)		Any (default: 50.0) *2
Timeout value		User specified (default: Packet interval (RPI) × 4) Set the timeout interval so that it is longer than the Sensor's measurement processing time.

*1: PLC tags and tag sets need to be same.

*2: Adjust this value based on the communications settings of the Sensor Controller (i.e., the output period and the output time). Reference: ► EtherNet/IP Communications Cycle (RPI) (p.215)

IMPORTANT

- If I/O memory addresses are specified for the communications areas, the information in the communications areas will be cleared when the operating mode of the PLC changes unless addresses in the CIO Area, which are maintained, are specified.
- The following assembly object is required to specify instances when the EDS file is not used.

Assembly Object Settings

Setting item	Setting	Description	Size
Instance	100	Output connection (for normal control and for line 0 in Multi-line Random Trigger Mode)	Total size of Command area and User Input area.*1
	101	Input connection (for normal control and for line 0 in Multi-line Random Trigger Mode)	Total size of Response area, Data output area and User output area.*2
	102	Output connection (for line 1 in Multi-line Random Trigger Mode)	Total size of Command area and User Input area.*1
	103	Input connection (for line 1 in Multi-line Random Trigger Mode)	Total size of Response area, Data output area and User output area.*2
	104	Output connection (for line 2 in Multi-line Random Trigger Mode)	Total size of Command area and User Input area.*1
	105	Input connection (for line 2 in Multi-line Random Trigger Mode)	Total size of Response area, Data output area and User output area.*2
	106	Output connection (for line 3 in Multi-line Random Trigger Mode)	Total size of Command area and User Input area.*1
	107	Input connection (for line 3 in Multi-line Random Trigger Mode)	Total size of Response area, Data output area and User output area.*2
	108	Output connection (for line 4 in Multi-line Random Trigger Mode)	Total size of Command area and User Input area.*1
	109	Input connection (for line 4 in Multi-line Random Trigger Mode)	Total size of Response area, Data output area and User output area.*2
	110	Output connection (for line 5 in Multi-line Random Trigger Mode)	Total size of Command area and User Input area.*1
	111	Input connection (for line 5 in Multi-line Random Trigger Mode)	Total size of Response area, Data output area and User output area.*2
	112	Output connection (for line 6 in Multi-line Random Trigger Mode)	Total size of Command area and User Input area.*1
	113	Input connection (for line 6 in Multi-line Random Trigger Mode)	Total size of Response area, Data output area and User output area.*2
	114	Output connection (for line 7 in Multi-line Random Trigger Mode)	Total size of Command area and User Input area.*1
115	Input connection (for line 7 in Multi-line Random Trigger Mode)	Total size of Response area, Data output area and User output area.*2	

*1: Total size which Command area size and User Input area size.

- 20 bytes (When you do not use the User area)
- 52 bytes (When you use the User area)

*2: Total size which Response area, Data output area and User Output area.

- When you select Result Data Format 0 in the Data output number.
 - 48 bytes (When you do not use the User area)
 - 80 bytes (When you use the User area)
- When you select Result Data Format 1 in the Data output number.
 - 80 bytes (When you do not use the User area)
 - 112 bytes (When you use the User area)
- When you select Result Data Format 2 in the Data output number.
 - 144 bytes (When you do not use the User area)
 - 176 bytes (When you use the User area)
- When you select Result Data Format 3 in the Data output number.
 - 272 bytes (When you do not use the User area)
 - 304 bytes (When you use the User area)

Output Data Settings (Processing Item Registration)

Use the following procedures to set the items to output to EtherNet/IP and the output format.

Registering Processing Items

Register the processing items for data output in the measurement flow.

- 1 Click [Edit flow] in Toolbar.
- 2 Select the [Fieldbus Data Output] processing item from the processing item tree.

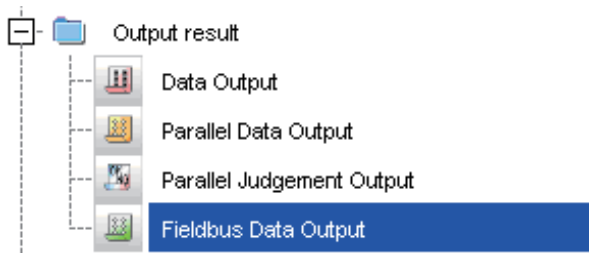

- 3 Click [Append].

The [Fieldbus Data Output] processing item is appended at the bottom of the unit list (flow).

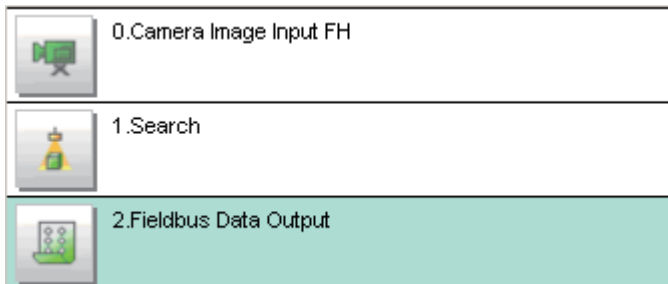

- 4 Click the [Fieldbus Data Output] icon () and set the data output items and data format.

Refer to the following references for details on the settings.

Reference: ► Registering the Items To Output (p.186)

IMPORTANT

Fieldbus Data Output

Specify the Communication setting before setting of Fieldbus Data Output.

Note that if you change the Communication settings after setting of Fieldbus Data Output, the changed settings are not displayed on the Fieldbus Data Output setting display.

Note

- The number of outputtable items for single data output processing is 8 to 64 depending on data output settings in each lines. If you need to output more data items, use more than one Output Unit.
However, the data is output to the same destination, so if you do not control the output, the output data that was output first will be overwritten by the output data that is output after it.
Use the following method to read each set of output data.

Controlling Data Output with Handshaking

If handshaking is used to control data output, the timing of outputting the data is controlled by I/O signals.
Each time that data is output, read the output data and move it to a different part of I/O memory in the PLC.
Refer to ► Data Output Control with Handshaking (p.32) for details on handshaking.

- Data is output in the order that data output is registered in the measurement flow, i.e., the timing is different for each data output processing item. (Data output is executed in the order that it is executed in the measurement flow.)
Reference: ► Outputting the Output Data (p.27)

Registering the Items To Output

Set expressions for the data to output.

- 1** Click the [Fieldbus Data Output] icon () in the measurement unit list (flow).
- 2** In the Item Tab Area, click [Setting].
- 3** In the list, select the output data number for the expression to set.

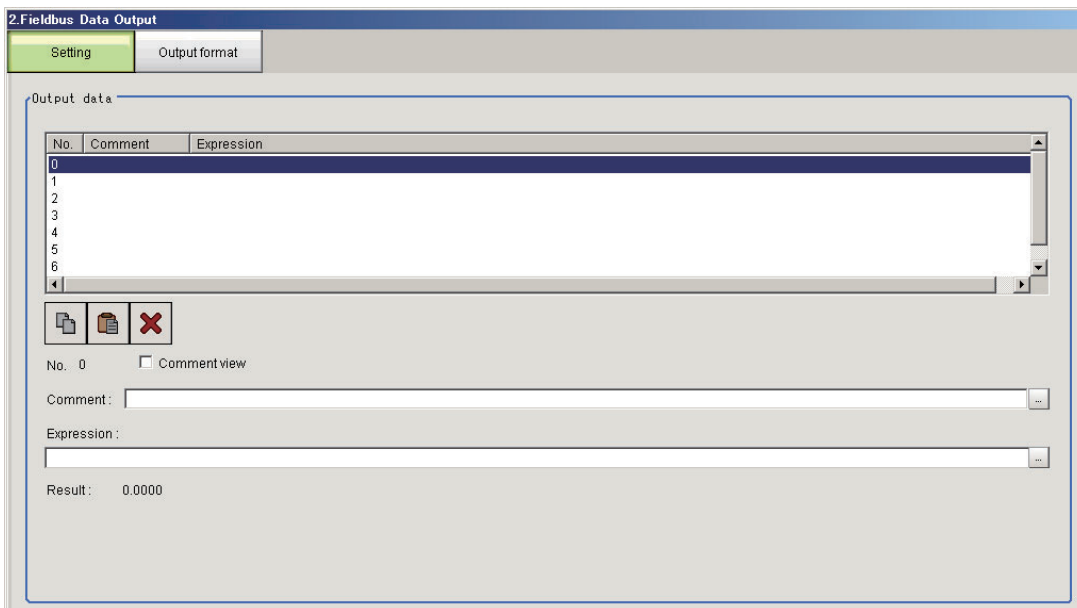

The selected output data number is displayed under the list.

4 Click the [...] button next to the expression box and set the expression.



Specify the processing items, measurement results, and measurement data in the expression.
 You can also perform arithmetic or function calculations on the measurement data before it is output.
 For calculation settings, refer to section of Calculation in *FH/FZ5 Processing Item Function Reference Manual* (Cat. No. Z341).

5 Click the [...] button for the [Comment] box and enter an explanation of the expression.

The comment you enter will be displayed in the detailed results on the Main Window.
 For example, if you enter “Test” as the comment for expression 0, “Test” will be displayed in place of “Expression 0” in the detailed results area on the Main Window.

6 Repeat steps 4 and 5 to set expressions for all of the required output data numbers.

Note

If you delete one of the expressions that is set for output data 0 through 7, the output numbers for all expressions after the deleted expression will stay the same. However, the actual data output will be output as though the list has been shifted forward for the number of expressions that have been deleted.
 To prevent data from being written to the wrong locations, use copy and paste to shift the expressions after the deleted number forward.
 For details on the Data Output Area, refer to ► Memory Allocation (p.238).

Example: If the Expression for Output 1 Is Deleted

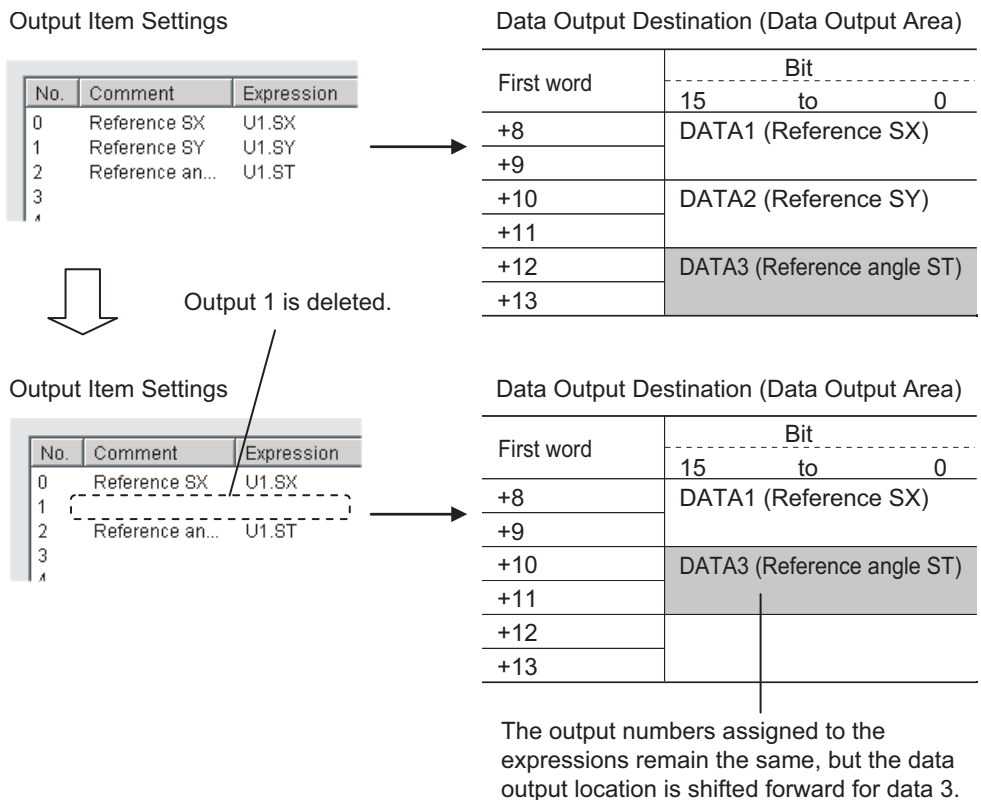

Output Format (Fieldbus Data Output)

- 1 Click the [Fieldbus Data Output] icon () in the measurement unit list (flow).
- 2 In the Item Tab Area, click [Output format].
- 3 Select the output format.

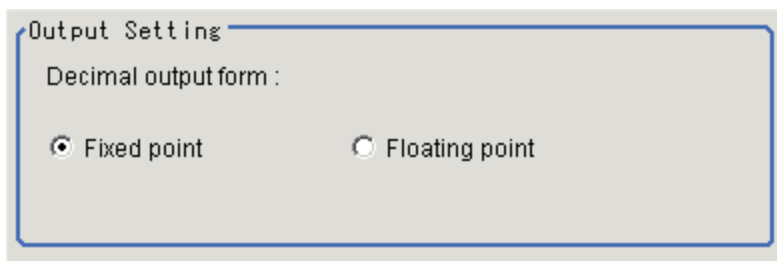

Set value [Factory default]	Description
Decimal output form	
[Fixed point]	Data is output multiplied by 1,000. Example: For 123.456, 0x0001E240
Floating point	Data is output in floating-point format. Example: For -123.4567, 0xc2f6e979

Testing Communications

You can check whether the EtherNet/IP communications settings are correct.

If communications cannot be performed even after set up the communications, use the following procedure to check the settings and the communications status.

Before Performing a Communications Test

This example assumes that [Serial (Ethernet)] – [Normal (UDP)] is selected as the Communications Module. Stop the program on the PLC when you check the communications settings.

Checking the Communications Settings

Use the following procedure to check if the communications settings are correct.

1. On the Main Window, select [Tool] – [System Settings]. In the tree view on the left, select [System Settings] – [Communication] – [Ethernet Normal (xyz)]. (“xyz” depends on the Communications Module.)

2. Set the IP address of the Sensor Controller. The default settings are as follows:
Address setting: 10.5.5.100
Address setting 2: 10.5.6.100

3. On the Main Window, select [Tool] – [System Settings]. Select [System Settings] – [Communication] – [EtherNet/IP] from the tree view on the left.

4. Click the [Settings] tab.

5. Set the output control. Set whether to provide an interlock with the PLC when performing data output.

* Output Period
Set the cycle by which measurement results are output. Set the value so that the interval is longer than the output time and shorter than measurement interval.

Output time

Set the interval during which the GATE signal (the signal that tells the PLC when to read the measurement results) is ON.

This interval must be longer than the cycle time of the PLC and the EtherNet/IP packet interval (RPI). Set these values so that they satisfy the following relationships:

$RPI < \text{Output time}$

$\text{GATE ON time} = \text{Output time}$

$\text{GATE OFF time} = \text{Output period} - \text{Output time}$

(The output period and output time are only valid when output control is set to [None].)

6. This completes the Controller settings. The PLC settings are set next.

Checking the Communications Status

Use the ping command to check if the Sensor Controller exists on the Ethernet network.

Use this to determine if the Sensor Controller's IP address has been set correctly and that the Sensor Controller is correctly connected to the Ethernet network.

Note

The ping command uses the ICMP protocol to send a response request to a device connected through an Ethernet network and determines the time required to respond to that request.

If you properly receive a response from the destination device, the network connection and network settings are correctly set.

1 Connect the Sensor Controller and computer with an Ethernet cable.

Set the left three segments of IP address of the computer to the same values as the Controller and set the right segment to a different value.

IP Address Setting Example

Device	Setting example
Sensor Controller	10.5.5.100 (default)
Computer	10.5.5.101

2 Open the Windows command prompt on the computer and execute the ping command.

At the ">" prompt, type "ping", followed by a space and the IP address of the Controller, and then press Enter.

Example:

```
C:\>ping 10.5.5.100
```

3 After a few seconds, if you see "Reply from" followed by the IP address of the Controller (e.g., 10.5.5.100), you will know that the Controller is connected to the Ethernet network.

Example:

```
Reply from 10.5.5.100: byte=32
time<1ms TTL=128
```

If Anything Other than "Reply from" Is Displayed

This means that the Controller is not connected to the network for some reason. Check the following.

- Are the left three segments of the IP addresses of the computer and the Controller the same?
- Is the Ethernet cable connected?

4 Use the ping command to also check the communications status of the PLC.

After you have confirmed the communications status as described above, send an actual measurement command to the Controller and check to confirm that Sensor Controller communications are operating correctly.

Memory Allocation

This section describes the assignments of the Command Area for the input connection to the Sensor and the Response Area and Output Area for the output connection to the PLC.

Input Connection to Sensor (PLC Originator to Sensor Controller Target)

For input connections to Sensors, specifies control input, command code command parameters and User Input Area.

- **Command Area**

First word in Command Area	Bit																Name
	15	14	13	12	11	10	9	8	7	6	5	4	3	2	1	0	
+0	ERCLR							XEXE							STEP	EXE	Control input (2 words)
+1																DSA	
+2	CMD-CODE																Command code (2 words)
+3																	
+4	CMD-PARAM																Command param- eters (6 words max.)
+5																	
+6																	
+7																	
+8																	
+9																	
+10	User Input Area 0																User Input Area 0
+11																	
+12	User Input Area 1																User Input Area 1
+13																	
+14	User Input Area 2																User Input Area 2
+15																	
+16	User Input Area 3																User Input Area 3
+17																	
+18	User Input Area 4																User Input Area 4
+19																	
+20																	
+21																	
+22	User Input Area 5																User Input Area 5
+23																	
+24																	
+25																	

Signal	Signal name	Function
EXE	Command Execution Bit	Executes a command. Reference: ► Command List (p.251)
DSA	Data Output Request Bit	Requests the next data output. Reference: ► Output Data Settings (Processing Item Registration) (p.232)
STEP	Measure Bit	Executes a measurement.
XEXE	Flow Command Request Bit	Executes a command during execution of fieldbus flow control.
ERCLR	Error Clear Bit	Clears the ERR signal from the Sensor Controller.
CMD-CODE	Command code	Stores the command code.
CMD-PARAM	Command parameters	Stores command parameters.
User Input Area 0 to 5	User Input Area 0 to 5	User can write the defined data to the Sensor Controller using Macro customize function. <ul style="list-style-type: none"> • Data type of User Input Area 0 to 3 is DINT. • Data type of User Input Area 4 to 5 is LREAL.

Output Connection to PLC (Sensor Controller Originator to PLC Target)

For output connections to the PLC, execution results and output data from the Sensor Controller are set. Outputs the executed results (control outputs, command codes, response codes and response data) from Sensor Controller to the response area. Similarly, outputs the output data or output data of User Output Area from Sensor Controller to the data output area.

Note

The order in which data is stored depends on the manufacturer of the connected PLC. For details, refer to ► Parameter Notation Examples for Command Control (p.350).

• Response Area

First word in Response Area	Bit																Name
	15	14	13	12	11	10	9	8	7	6	5	4	3	2	1	0	
+0	ERR					XWAIT	XBUSY	XFLG				RUN	OR		BUSY	FLG	Control output (2 words)
+1																GATE	
+2	CMD-CODE																Command code (2 words)
+3																	
+4	RES-CODE																Response code (2 words)
+5																	
+6	RES-DATA																Response data (two words)
+7																	

• Data Output Area

The data of User Output Area will be output next the number of output data specified in the EtherNet/IP when you use User Area. For this reason, the first channel of User Output Area will be change depend on the output data number.

Describe The mapping of data output area and User Output Area when the output data number is selected as Result Data Format 0 (32 bytes) as below.

First word in Response Area	Bit																Name
	15	14	13	12	11	10	9	8	7	6	5	4	3	2	1	0	
+8	DATA0																Output data 0
+9																	
+10	DATA1																Output data 1
+11																	
+12	DATA2																Output data 2
+13																	
+14	DATA3																Output data 3
+15																	
+16	DATA4																Output data 4
+17																	
+18	DATA5																Output data 5
+19																	

First word in Response Area	Bit																Name
	15	14	13	12	11	10	9	8	7	6	5	4	3	2	1	0	
+20	DATA6																Output data 6
+21																	
+22	DATA7																Output data 7
+23																	
+24	User Output Area 0																User Output Area 0
+25																	
+26	User Output Area 1																User Output Area 1
+27																	
+28	User Output Area 2																User Output Area 2
+29																	
+30	User Output Area 3																User Output Area 3
+31																	
+32	User Output Area 4																User Output Area 4
+33																	
+34																	
+35																	
+36	User Output Area 5																User Output Area 5
+37																	
+38																	
+39																	

Signal	Signal name	Function
FLG	Command Completion Bit	Turns ON when command execution is completed.
GATE	Data Output Completion Bit	Turns ON when data output is completed.
BUSY	Command Busy Bit	Turns ON when command execution is in progress.
OR	Overall Judgement	Turns ON when the overall judgement result is NG. (The OR signal is output when the checkbox for [Output] is selected in the ADJUST window.)
XFLG	Flow Command Completion Bit	Turns ON when execution of a command that was input during the execution of fieldbus flow control has been completed (i.e., when XBUSY turns OFF).
XBUSY	Flow Command Busy Bit	Turns ON when execution of a command that was input during execution of fieldbus flow control is in progress.
XWAIT	Flow Command Wait Bit	Turns ON when a command can be input during the execution of fieldbus flow control.
RUN	Run Mode	Turns ON when the Sensor Controller is set to the Run Mode.
ERROR	Error Signal	Turns ON when the Sensor Controller detects an error signal.
CMD-CODE	Command code	Returns the executed command code.
RES-CODE	Response code	Stores the response from the executed command.
RES-DATA	Response data	Stores the response data from the executed command.
DATA0-7	Output data 0 to 7	Outputs the data set in the output processing items. When there are multiple processing items, data is overwritten to this area while handshaking is performed.
User Input Area 0 to 5	User Input Area 0 to 5	The FH Sensor Controller writes in data defined by you in this area using Macro customize functions. <ul style="list-style-type: none"> • Data type of User Output Area 0 to 3 is DINT. • Data type of User Output Area 4 to 5 is LREAL.

Accessing Communications Areas Using Variables with NJ-series Controllers

With an NJ-series Controller, only variables can be used to access from the user program the I/O memory addresses that are assigned to the communications areas.

Use the following settings.

Using Network Variables for Access

Create user-defined variables that match the structures of the communications areas of the Sensor.

Use the Sysmac Studio to define the variables.

Refer to the ► *Sysmac Studio Version 1 Operation Manual* (Cat. No. W504) for Sysmac Studio operating procedures.

1 Defining the Data Types of the Variables

Define data types for variables that match the structures of the communications areas.

(1) Defining a Data Type for Signal Access

First, define a BOOL array data type to access the control signals and status signals.

Here, a data type called "U_EIPFlag" is defined.

Name of data type: U_EIPFlag

Type of derivative data type: Union

Name of data type	Data type	
U_EIPFlag	UNION	
F	ARRAY[0..31]OF BOOL Specifies an array of BOOL data from 0 to 31.
W	DWORD 32-bit bit string data

(2) Defining Data Types for Communications Area Access

Data types are defined to access the communications areas, with one data type for the Command Area and another data type for the Response Area and Output Area.

Here, data types called "S_EIPOutput" and "S_EIPInput" are defined.

- Data Type to Access the Command Area

Name of data type: S_EIPOutput

Type of derivative data type: Structure

Name of data type	Data type	
S_EIPOutput	STRUCT	
ControlFlag	U_EIPFlag The data type that was defined above (1)
CommandCode	DWORD 32-bit bit string data
CommandParam1	DINT 32-bit integer data
CommandParam2	DINT 32-bit integer data
CommandParam3	DINT 32-bit integer data

- Assignment Example for Variable Data Type That Matches the Command Area

(Refer to ► Input Connection to Sensor (PLC Originator to Sensor Controller Target) (p.238))

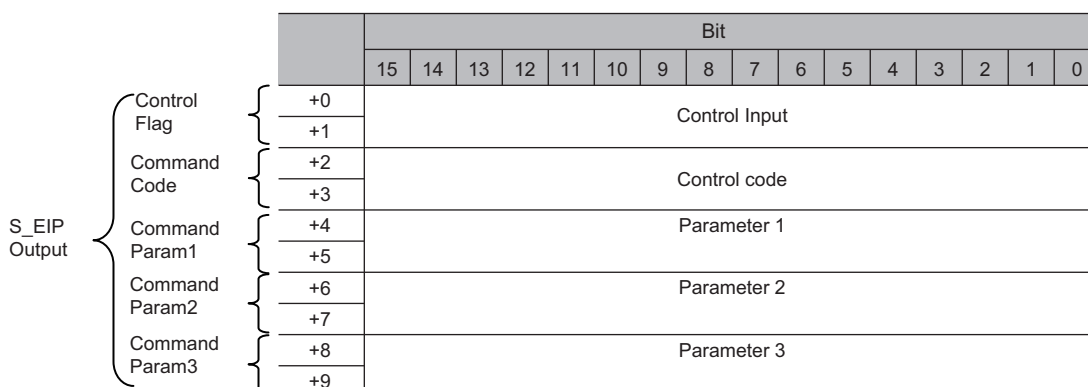

- Data Type to Access the Response and Output Areas

Name of data type: S_EIPInput

Type of derivative data type: Structure

Name of data type	Data type	
S_EIPInput	STRUCT	
StatusFlag	U_EIPFlagThe data type that was defined above (1)
CommandCodeEcho	DWORD32-bit bit string data
ResponseCode	DWORD32-bit bit string data
ResponseData	DINT32-bit integer data
OutputData	ARRAY[0..7]OF DINTSpecifies an array of DINT data from 0 to 7.

- Assignment Example for Variable Data Type That Matches the Response and Output Areas (Refer to ► Output Connection to PLC (Sensor Controller Originator to PLC Target) (p.240))

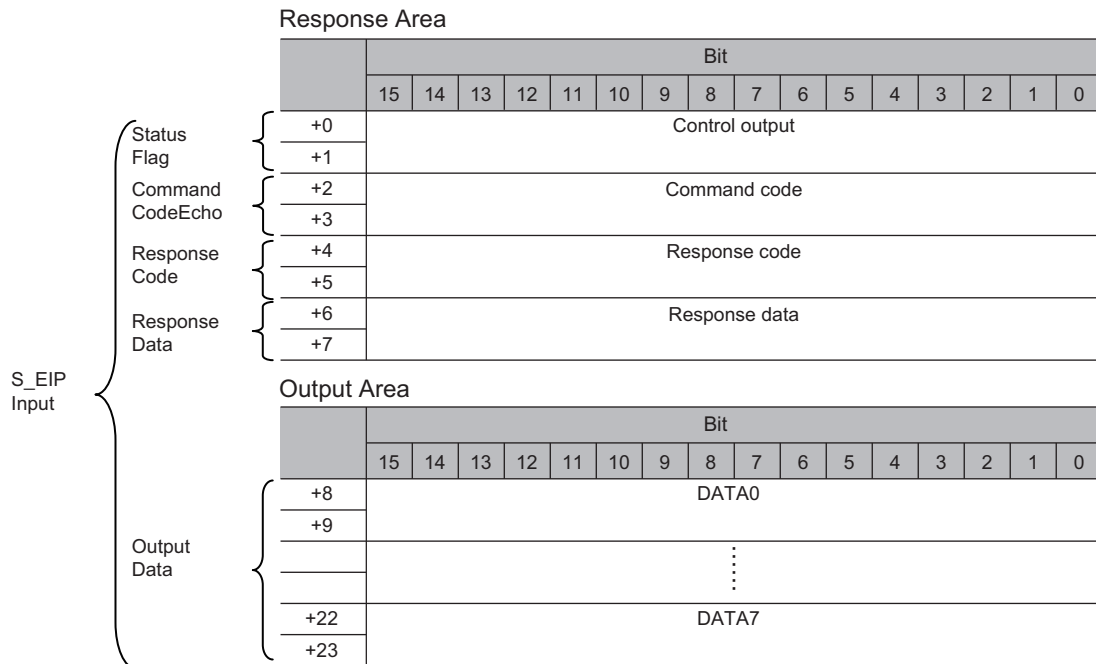

2 Defining the Variables

Define variables for the data links for the communications area data that is used in EtherNet/IP communications.

These variables use the data types that were defined above in procedure 1.

Variable	Variable type	Network Publish attribute	Data type	Application
EIPOutput	Global variable	Output	S_EIPOutput	For data links to the Command Area
EIPInput	Global variable	Input	S_EIPInput	For data links to the Response Area and Output Area

3 Exporting the Variables That Were Defined on Sysmac Studio

Export the variables that you defined so that you can use them on the Network Configurator.

An exported CSV file is created.

4 Network Configurator Settings

- (1) Import to the Network Configurator the CSV file that you exported from the Sysmac Studio.

The variables that are imported will automatically be registered as tags.

(2) Set the connections as shown in the following table.

Originator device (PLC) settings	Target device (Sensor) settings
Input tag set: EIPOutput	Output tag set: Input101
Output tag set: EIPIInput	Input tag set: Output100

5 Accessing the Communications Areas from the User Program

The defined variables are used to access the communications areas for the Sensor using the following

- Command Area

Signal name	Variable name
EXE	EIPOutput.ControlFlag.F[0]
STEP	EIPOutput.ControlFlag.F[1]
XEXE	EIPOutput.ControlFlag.F[8]
ERCLR	EIPOutput.ControlFlag.F[15]
DSA	EIPOutput.ControlFlag.F[16]
Command code	EIPOutput.CommandCode
Command parameter 1	EIPOutput.CommandParam1
Command parameter 2	EIPOutput.CommandParam2
Command parameter 3	EIPOutput.CommandParam3

- Response Area

Signal name	Variable name
FLG	EIPIInput.StatusFlag.F[0]
BUSY	EIPIInput.StatusFlag.F[1]
OR	EIPIInput.StatusFlag.F[3]
RUN	EIPIInput.StatusFlag.F[4]
XFLG	EIPIInput.StatusFlag.F[8]
XBUSY	EIPIInput.StatusFlag.F[9]
XWAIT	EIPIInput.StatusFlag.F[10]
ERR	EIPIInput.StatusFlag.F[15]
GATE	EIPIInput.StatusFlag.F[16]
Command code	EIPIInput.CommandCodeEcho
Response code	EIPIInput.ResposeCode
Response data	EIPIInput.ResposeData

- Output Area

Signal name	Variable name
Output data 1	EIPIInput.OutputData[0]
	⋮
Output data 8	EIPIInput.OutputData[7]

Accessing Communications Areas by Specifying I/O Memory Addresses

AT specifications can be set for variables to individually specify the I/O memory addresses that are assigned in the communications areas.

1 Setting Tag Sets (Network Configurator)

Specify the tag names in the PLC directly by using the I/O memory addresses that are assigned in the communications areas. (Output tags are specified for the input connections to the Sensor and input tags are specified for output connections to the PLC.)

Setting Examples

Tag type	Allocated I/O memory address
Output tag	D0
Input tag	D100

2 Setting Variables (Sysmac Studio)

Define variables with AT specifications to the I/O memory addresses that are assigned in the communications areas as shown below.

Setting Examples

Variable	AT specification
a	D0.0
b	D0.1
c	D0.15
d	D1.0

3 Setting Connections

Set the connections as shown in the following table.

Originator device (PLC) settings	Target device (Sensor) settings
Input tag set: D0	Output tag set: Input101
Output tag set: D100	Input tag set: Output100

Example: Setting Example for Variables to Access the Command Area

Command Area (PLC Output Tag D0)

I/O memory address
D0
D1
⋮

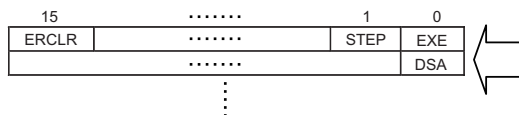

Variables Used to Access the Command Area in the PLC from the User Program

Variable name	Settings	
	AT specification	Data type
a (Assigned to the EXE signal.)	D0.0	BOOL
b (Assigned to the STEP signal.)	D0.1	BOOL
c (Assigned to the ERCLR signal.)	D0.15	BOOL
d (Assigned to the DSA signal.)	D1.0	BOOL

I/O Signals

The following tables list the signals that are used to control I/O for EtherNet/IP.

Input Signals

Signal	Signal name	Function	ON/OFF timing	
			OFF to ON	ON to OFF
EXE	Command Request Signal	Turn ON this signal (from the PLC) to send a command to the Sensor Controller.	Turn ON the signal (from the PLC) to send a command to the Sensor Controller and request execution based on the command code and command parameters.	Switch OFF the signal (from the PLC) when the FLG signal from the Sensor Controller turns ON. ^{*1}
DSA (Used only for hand-shaking output control.)	Data Output Request Signal	This signal is to request to externally output that measurement data from the flow which was executed by the PLC at handshake time. If this signal is ON when an Output Unit (Fieldbus Data Output Unit) in the measurement flow is executed, the Sensor Controller will output the data from the processing item.	<ul style="list-style-type: none"> This signal turns ON when PLC output the data to the external device. ^{*3} Turn ON this DSA signal at the same time the STEP signal or EXE signal turns ON. If multiple Output Units are used to output more than 8 items of output data, turn ON the Result Set Request (DSA) signal again after the Result Completion (GATE) signals turns OFF. Reference: ► Time Charts (p.260)	Switch OFF the signal (from the PLC) when the GATE signal from the Sensor Controller turns ON. ^{*2}
ERCLR	Error Clear Bit	Turn ON this signal to clear the ERR signal from the Sensor Controller.	Turn ON the signal (from the PLC) when the Error Status (ERR) signal turns OFF.	Turn OFF the signal (from the PLC) when the Error Status (ERR) signal turns OFF.
XEXE	Flow Command Request Bit	Turn ON this signal to execute a command during execution of fieldbus flow control.	Turn ON the signal (from the PLC) to request execution of a command that was input during execution of fieldbus flow control.	Switches from ON back to OFF when the XFLG signal turns ON.
STEP	Measurement trigger	Turn ON this signal to execute measurements.	Turn ON this signal (from the PLC) to execute measurement after checking that the Busy signal and the FLG signal are ON.	Switches this signal from ON back to OFF (from the PLC) after the PLC detects that the Busy signal from the FH turns ON.

- *1: A timeout error will occur if you turn off the Command request (EXE) signal within 10 seconds after the Command Execution Completion (FLG) signal is turned ON.
Command Execution Completion (FLG) signal and BUSY signal will be forcefully turned OFF.
- *2: If the DSA signal does not change from ON to ON within the timeout time set in the EtherNet/IP settings after the data output done signal (GATE signal) turns ON, a timeout error occurs and the measurement data that is ready for output is discarded.
- *3: If the DSA signal does not change from OFF to ON within the [Timeout] time set in the EtherNet/IP settings after the measurement trigger signal (STEP signal) or control command signal (EXE signal) changes from OFF to ON and measurement starts, a timeout error occurs and the measurement data that is ready for output is discarded.

Output Signals

Signal	Signal name	Function	ON/OFF timing	
			OFF to ON	ON to OFF
BUSY	Busy Signal	<p>This signal tells when commands and other external inputs cannot be acknowledged. Make sure this signal is OFF before you request a command.</p> <p>*1: During continuous measurement, the BUSY signal remains ON. The Sensor Controller accepts the EXE signal only after receiving the End Continuous Measurement command.</p> <p>*2: The execution of commands or other processing received through any other protocol cannot be detected. (Example: This signal remains OFF during measurements for a parallel communications STEP signal.) If you use more than one protocol and need to detect command execution, use the parallel communications BUSY signal.</p> <p>*3: Just because this signal is ON does not necessarily mean that a command is being executed. To check whether the command is being executed, check the status of the FLG signal.</p>	The signal turns ON when the Sensor Controller receives a command from the user (PLC). (The signal turns ON after the EXE signal turns ON.)	The signal turns OFF when execution of the command is completed.
FLG	Command Execution Completion	The Sensor Controller uses this signal to tell the user (PLC) that command execution has been completed.	The signal turns ON when the Sensor Controller completes execution of a command that it received.	Turns OFF when the user (PLC) switches the EXE signal from ON to OFF.

Signal	Signal name	Function	ON/OFF timing	
			OFF to ON	ON to OFF
GATE	Data Output Completion Signal	<p>This signal tells the timing to load the output data to the User (PLC).</p> <p>This signal is ON: means that the data is output from Sensor Controller.</p> <p>Read the data (from the PLC) when this signal turns ON.</p>	<ul style="list-style-type: none"> • No Handshaking: After execution^{*4} of the Fieldbus Data Output unit in the measurement flow by the Sensor Controller, the signal turns ON if the data is ready to be output. • Handshaking: After execution^{*4} of the Fieldbus Data Output unit in the measurement flow by the Sensor Controller, the signal turns ON if the data is ready to be output and the DSA signal is ON. <p>*4: This occurs when the Output Unit is executed as the measurement flow is executed in order from the top. It does not occur when execution of a measurement is completed.</p>	<ul style="list-style-type: none"> • No Handshaking: The signal turns OFF after the output time that is set in the EtherNet/IP settings has elapsed. • Handshaking: This signal turns OFF when the user (PLC) switches the DSA signal from ON to OFF.
ERR	Error Signal	<p>The Sensor Controller provides notification with this signal when it detects the following errors.</p> <p>Refer to the following references for details on errors.</p> <p>Refer to ► <i>Error Messages and Troubleshooting in the Vision System FH/FZ5 Series User's Manual</i> (Cat. No. Z365).</p>	<p>The signal turns ON then the Sensor Controller detects an error.</p>	<p>The signal turns OFF when the error is eliminated and the user (PLC) performs another measurement or clears the error (i.e., turns ON the Error Clear (ERCLR) signal).</p>
RUN	Run Mode	<p>This signal tells when the Sensor Controller is in Run Mode.</p>	<p>The signal turns ON when the Sensor Controller is in RUN Mode.</p>	<p>The signal turns OFF when the Sensor Controller is in Adjustment Mode.</p>
OR	Overall Judgement	<p>This signal gives the results of the overall judgement.</p>	<p>The signal turns ON when the overall judgement is NG.</p>	<p>The signal turns OFF when the overall judgement is OK.</p>
XFLG	Flow Command Execution Completion	<p>This signal tells when execution of a command that was executed during execution of fieldbus flow control has been completed.</p>	<p>The signal turns ON when execution of a command that was executed during execution of fieldbus flow control has been completed (i.e., when Flow Command Busy turns OFF).</p>	<p>This signal turns OFF when the XBUSY signal turns ON during execution of Fieldbus flow control.</p>
XBUSY	Flow Command Busy Bit	<p>This signal tells when a command that was input during execution of fieldbus flow control is being executed.</p>	<p>The signal is ON when a command that was input during execution of the fieldbus flow control is being executed.</p>	<p>This signal turns OFF when execution of an input command is completed during execution of Fieldbus flow control.</p>

Signal	Signal name	Function	ON/OFF timing	
			OFF to ON	ON to OFF
XWAIT	Flow Command Wait Bit	This signal tells when input of a command can be acknowledged during execution of fieldbus flow control.	The signal is ON when a command can be input during execution of fieldbus flow control.	The signal is OFF when a command cannot be input during execution of the fieldbus flow control.

Output Items

Measurement Results for Which Output Is Possible (Fieldbus Data Output)

You can use the processing items that are related to outputting results to output the following data. You can also access measured values from the Calculation or other processing units.

Measured item	Text string	Description
Judgement	JG	Judgement result
Data 0 to 7	D00 to D07	Results of expressions set for output data 0 to 7

External Reference Tables (Fieldbus Data Output)

By specifying a number, the following data can be referenced from control commands or processing items that have a set/get unit data function.

Number	Data name	Set/Get	Data range
0	Judgement	Get only	0: No judgement (unmeasured) 1: Judgement result OK -1: Judgement result NG
5 to 12	Data 0 to Data 7	Get only	• ASCII: -99999999.9999 to 999999999.9999 • Binary: -2147483.648 to 2147483.647
150	Output type	Set/Get	0: Fixed point 1: Floating point

Command List

This section explains each command used in EtherNet/IP.

A command with a description of command area head word can be executed with both tag data link communication and message communication.

A command without a description in the *First word in Command Area* column (---) can be executed only with message communications.

For details on tag data link communications commands, refer to ► Command Details for PLC Link, EtherNet/IP, and EtherCAT (p.361).

Execution Commands

First word in Command Area		Function	Reference
+3	+2		
0010	1010	Performs one measurement.	Reference: ► (p.361)
0010	1020	Starts continuous measurement.	Reference: ► (p.361)
0010	1030	Completes continuous measurement.	Reference: ► (p.362)
0010	1040	Executes a test measurement for the specified Unit.	Reference: ► (p.362)
0010	2010	Clears measurement values.	Reference: ► (p.363)
0010	3010	Saves data in the Sensor Controller.	Reference: ► (p.364)
0010	4010	Re-registers the model data with the current image.	Reference: ► (p.365)
0010	5010	Shifts the image display position by the specified amount.	Reference: ► (p.366)
0010	5020	Zooms the image display in or out by the specified factor.	Reference: ► (p.366)
0010	5030	Returns the display position and display magnification to their default values.	Reference: ► (p.367)
0010	7010	Copies the scene data.	Reference: ► (p.368)
0010	7020	Deletes the scene data.	Reference: ► (p.368)
0010	7030	Stores the scene data.	Reference: ► (p.369)
---	---	Registers the specified image data as a registered image.	Reference: ► (p.495)
0010	8020	Loads the specified registered data as a measurement image.	Reference: ► (p.370)
0010	9010	Returns the input character string as is to output (echo).	Reference: ► (p.371)
---	---	Adds a user account to a specified group ID.	Reference: ► (p.517)
---	---	Deletes a specified user account.	Reference: ► (p.518)
0010	B010	Branches to the start of the measurement flow (processing unit 0).	Reference: ► (p.373)
0010	F010	Restarts the Sensor Controller.	Reference: ► (p.374)

Commands to Get Status

First word in Command Area		Function	Reference
+3	+2		
0020	1000	Gets scene number.	Reference: ► (p.374)
0020	2000	Gets the scene group number.	Reference: ► (p.375)
0020	4000	Gets the number of the layout that is currently displayed.	Reference: ► (p.376)
0020	5010	Gets the number of the unit that is currently displayed in the specified Image Display Pane.	Reference: ► (p.376)
0020	5020	Gets the subimage number for the specified Image Display Pane.	Reference: ► (p.377)
0020	5030	Gets the image mode for the specified Image Display Pane.	Reference: ► (p.378)
0020	7010	Gets the input status (enabled/disabled) for the Communications Modules.	Reference: ► (p.378)
0020	7020	Gets the output status (enabled/disabled) to external devices.	Reference: ► (p.379)
0020	8010	Gets the ON/OFF status of the specified parallel I/O terminal.	Reference: ► (p.380)
0020	8020	Gets the ON/OFF status of all parallel terminals except for DI terminals.	Reference: ► (p.381)
0020	8030	Gets the ON/OFF status of all parallel DI terminals.	Reference: ► (p.385)
---	---	Gets the user name for the currently logged in user account.	Reference: ► (p.471)
---	---	Gets the affiliation group ID for the currently logged in user account.	Reference: ► (p.473)
0020	A000	Gets the current state of the operation log.	Reference: ► (p.389)

Commands to Set Status

First word in Command Area		Function	Reference
+3	+2		
0030	1000	Changes the scene number.	Reference: ► (p.390)
0030	2000	Switches the scene group number.	Reference: ► (p.390)
0030	4000	Sets the layout number and changes the image.	Reference: ► (p.390)
0030	5010	Sets the number of the Unit to display in the specified Image Display Pane.	Reference: ► (p.392)
0030	5020	Sets the number of the subimage to display in the specified Image Display Pane.	Reference: ► (p.392)
0030	5030	Sets the image mode for the specified Image Display Pane.	Reference: ► (p.393)
0030	7010	Enables/disables inputs to the Communications Modules.	Reference: ► (p.394)
0030	7020	Enables/disables outputs to external devices.	Reference: ► (p.394)
0030	8010	Sets the ON/OFF status of the specified parallel I/O terminal.	Reference: ► (p.395)
0030	8020	Sets the ON/OFF status of all parallel terminals, except for DO terminals.	Reference: ► (p.397)
0030	8030	Sets the ON/OFF status of all parallel DO terminals.	Reference: ► (p.401)
---	---	Changes the user account used by the user currently logging in.	Reference: ► (p.472)
0030	A000	Sets the state of the operation log.	Reference: ► (p.404)

Commands to Read Data

First word in Command Area		Function	Reference
+3	+2		
0040	1000	Gets the unit data.	Reference: ► (p.405)
---	---	Gets the current date and time.	Reference: ► (p.436)
---	---	Gets system version information.	Reference: ► (p.519)
---	---	Gets settings related to image logging.	Reference: ► (p.505)
---	---	Gets the defined image logging folder name.	Reference: ► (p.452)
---	---	Gets the defined data logging folder name.	Reference: ► (p.433)
---	---	Gets the defined screen capture folder name.	Reference: ► (p.446)
---	---	Gets the set image logging prefix.	Reference: ► (p.454)
0040	4050	Gets the conditions that are set for data logging.	Reference: ► (p.410)
0040	4060	Gets the parallel DI terminal offset data that is set.	Reference: ► (p.411)

Commands to Write Data

First word in Command Area		Function	Reference
+3	+2		
0050	1000	Sets the unit data.	Reference: ► (p.412)
---	---	Sets the date/time.	Reference: ► (p.437)
---	---	Changes settings related to image logging.	Reference: ► (p.507)
---	---	Sets the screen capture folder name.	Reference: ► (p.453)
---	---	Sets the data logging folder name.	Reference: ► (p.434)
---	---	Sets the screen capture folder name.	Reference: ► (p.447)
---	---	Sets the image logging prefix.	Reference: ► (p.455)
0050	4050	Sets the data logging conditions.	Reference: ► (p.417)
0050	4060	Sets the parallel DI terminal offset data.	Reference: ► (p.417)

File Load Commands

First word in Command Area		Function	Reference
+3	+2		
---	---	Loads the scene data.	Reference: ► (p.501)
---	---	Loads the scene group data.	Reference: ► (p.503)
---	---	Loads system data.	Reference: ► (p.509)
---	---	Loads System + Scene group 0 data.	Reference: ► (p.427)

File Save Commands

First word in Command Area		Function	Reference
+3	+2		
---	---	Saves the scene data.	Reference: ► (p.502)
---	---	Saves the scene group data.	Reference: ► (p.504)
---	---	Saves system data.	Reference: ► (p.510)
---	---	Saves the image data.	Reference: ► (p.464)
---	---	Saves all the image data in the image buffer (specified with [main unit logging image]).	Reference: ► (p.426)
---	---	Saves the last logging image.	Reference: ► (p.468)
---	---	Saves System + Scene Group 0 data in a file.	Reference: ► (p.428)
---	---	Captures the screen.	Reference: ► (p.444)

Command Response Processing

The ON/OFF timing of related signals from command input in control command response processing is indicated in the timing chart below.

Timing Chart for Command Execution

The commands for measurement execution or other processing that are stored in advance in the memory of the PLC are input and executed when you turn ON the Command Request (EXE) signal.

The Command Completion (FLG) signal turns ON when execution of the control command is completed. Use this as the trigger to turn OFF the Command Request (EXE) signal.

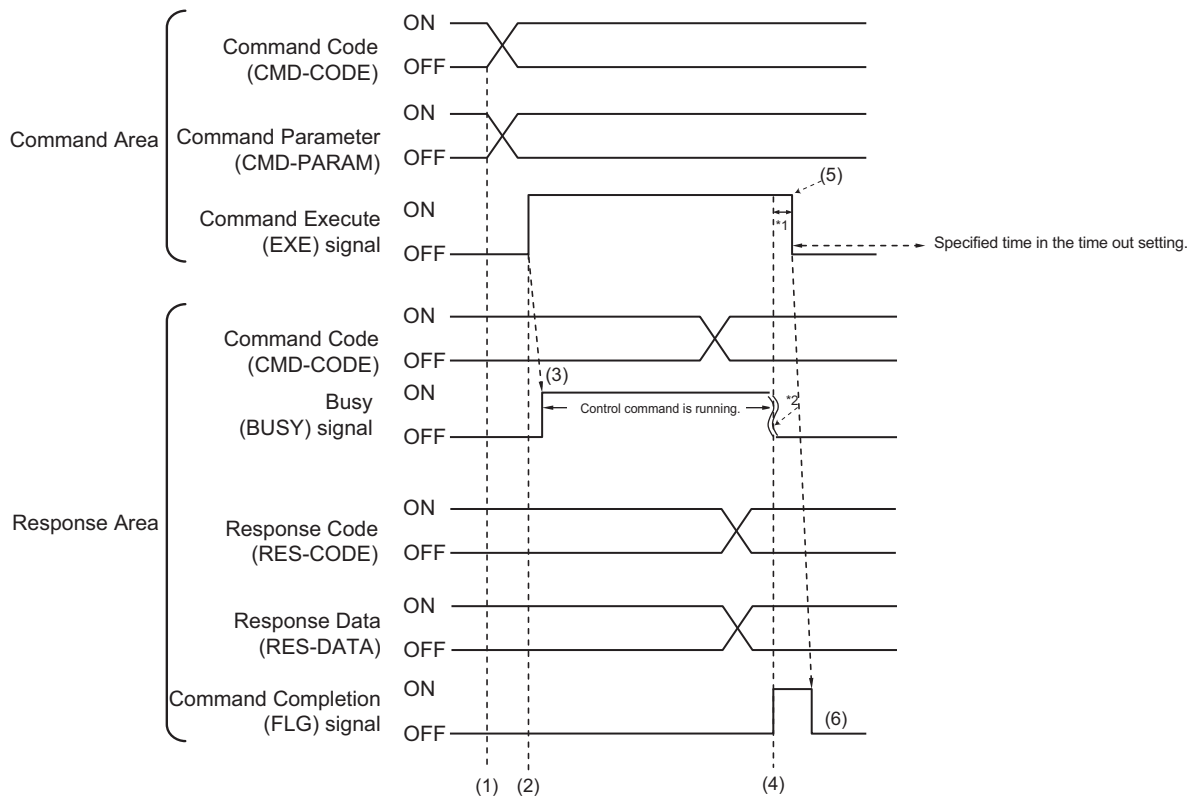

*1: A timeout error will occur if you do not turn off the Command Execution (EXE) signal within 10 seconds after the Command Completion (FLG) signal is turned ON.

Command Completion (FLG) signal and BUSY signal will be forcefully turned OFF.

*2: Busy (BUSY) signal is automatically switched ON to OFF when the command execution is completed.

- 1** The command code and command parameters are set from the PLC.
- 2** Next, confirm that the Busy (BUSY) signal and the Command Completion (FLG) signal have turned OFF and then turn ON the Command Request (EXE) signal again. A request is sent to the Sensor Controller.
- 3** The Sensor Controller executes the command and turns ON the Busy (BUSY) signal when the request is received.
- 4** The Busy (BUSY) signal is turned OFF when the Sensor Controller has finished execution.
- 5** The PLC (user) turns OFF the Command Request (EXE) signal when the Command Completion (FLG) signal turns ON.
- 6** The Sensor Controller confirms that the Command Request (EXE) signal is OFF and automatically turns OFF the Command Completion (FLG) signal.

Continuous Measurement Command without Handshaking

Continuous execution is used to repeatedly execute measurements by starting the next measurement operation (image input and measurement processing) as soon as one measurement operation (image input and measurement processing) is completed.

Continuous measurements are started when the Start Continuous Measurements command is executed and ended when the End Continuous Measurements command is executed.

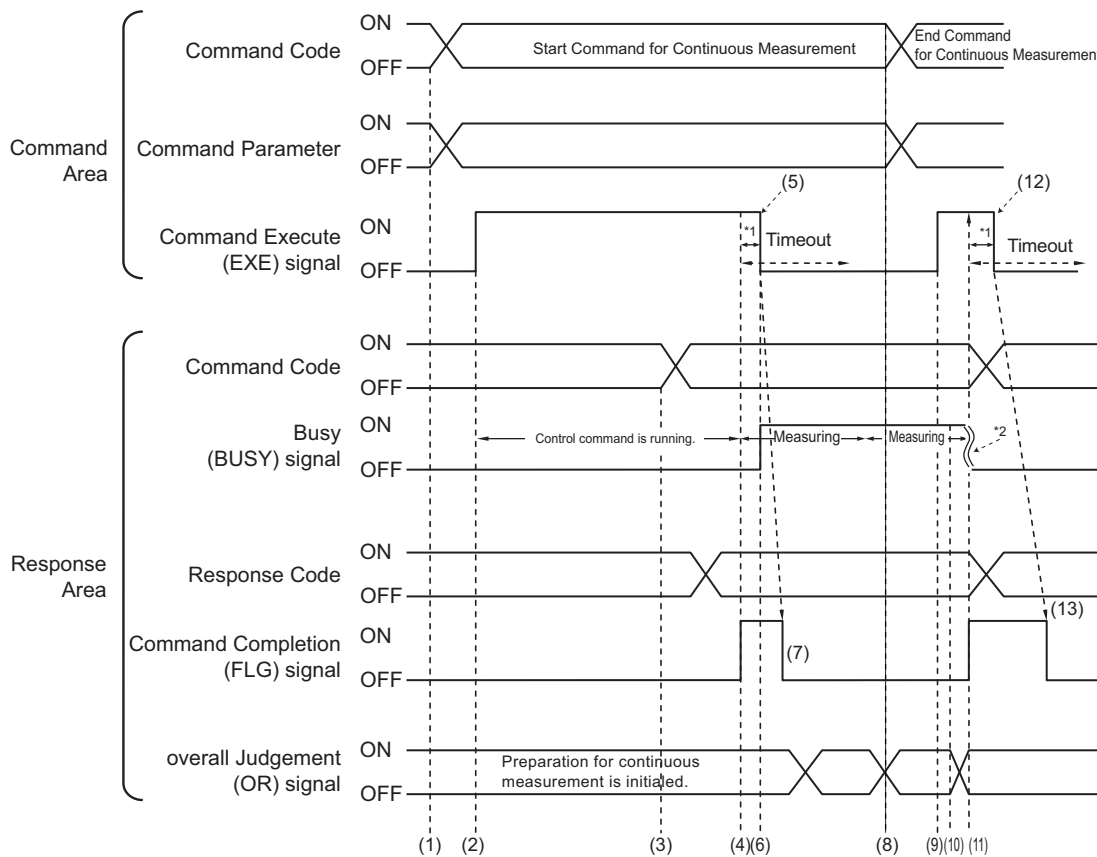

*1: A timeout error will occur if you do not turn off the Command Execution (EXE) signal within 10 seconds after the Command Completion (FLG) signal is turned ON.

Command Completion (FLG) signal and BUSY signal will be forcefully turned OFF.

*2: Busy (BUSY) signal is automatically switched ON to OFF when the command execution is completed.

Operation to Start Continuous Measurements

- 1** The Start Continuous Measurements command code is set from the PLC (user).
- 2** The Sensor Controller then checks that the Busy (BUSY) signal and Command Completion (FLG) signal are OFF, and switches the Command Request (EXE) signal from OFF to ON. The execution instruction is sent to the Sensor Controller.
- 3** The Sensor Controller sets the command code and response code when preparations for continuous measurement have been completed.
- 4** The Command Completion (FLG) signal is then turned ON.
- 5** The PLC (user) turns OFF the Command Request (EXE) signal when the Command Completion (FLG) signal turns ON.
- 6** When the Sensor Controller detects that the Command Request (EXE) signal has turned OFF, it starts continuous measurements and turns ON the Busy (BUSY) signal.
- 7** After that, Command Completion (FLG) signal is turned OFF automatically.

Operation to End Continuous Measurements

- 8** The End Continuous Measurements command code is set from the PLC (user) during execution of continuous measurements for a Start Continuous Measurements command.
- 9** The Command Request (EXE) signal is then turned ON. A request is sent to the Vision Sensor.

Note

Continuous measurements are not ended in the middle of a measurement. When the End Continuous Measurements command is executed, continuous measurements are ended after the measurement that is currently being executed is completed.

• Ending Continuous Measurements

- 10** The Sensor Controller stops continuous measurements and turns OFF the BUSY signal when it receives an execution request.
- 11** The Sensor Controller sets the command code and response code and then it turns ON the Command Completion (FLG) signal.
- 12** The PLC (user) turns OFF the Command Request (EXE) signal when the Command Completion (FLG) signal turns ON.
- 13** When the Sensor Controller detects that the Command Request (EXE) signal is OFF, it automatically turns OFF the Command Completion (FLG) signal.

IMPORTANT

- The measurements during continuous measurements are given priority. Therefore, display of the measurement results (overall judgment, images, judgment for each processing unit in the flow display, and detailed results) may sometimes not be updated.
- When continuous measurements are ended, the measurement results from the last measurement will be displayed.

• Performing Measurements with the STEP Signal

In addition to inputting the Command Request (EXE) signal as a trigger to execute a measurement command, you can also perform measurements by inputting the Measurement Trigger Execute (STEP) signal.

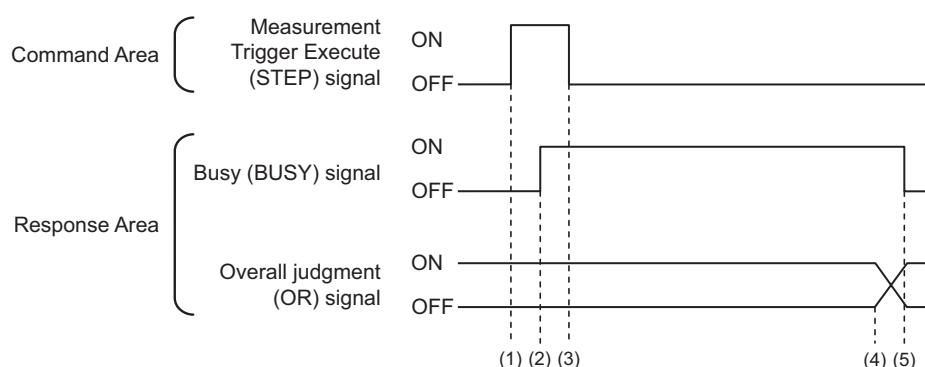

- 1** Measurement starts when the Measurement Trigger Execute (STEP) signal turns ON while the Busy (BUSY) signal is OFF.
- 2** The Busy (BUSY) signal turns ON when measurement begins.
- 3** Turn OFF the Measurement Trigger Execute (STEP) signal when the Busy (BUSY) signal turns ON.
- 4** The OR of the Overall judgment (OR) signal is output when measurements are completed.
- 5** The Busy (BUSY) signal turns OFF when the measurement flow is completed.

Data Output

The ON/OFF timing of signals related to data output after completion of measurement is indicated in the timing chart below.

No Handshaking

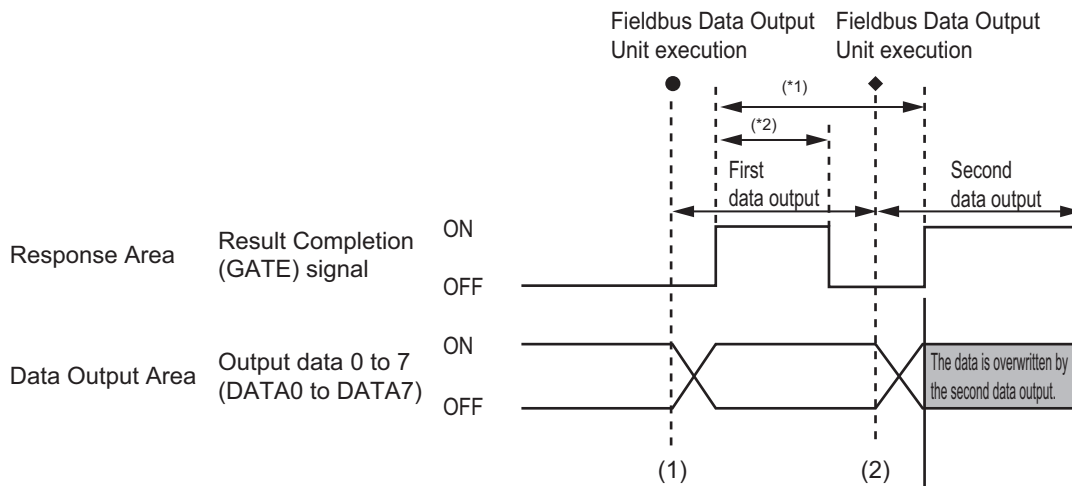

*1, *2: Data is output at the set output period^{*1} and for the set output time.^{*2}
After the data is output, the GATE signal is turned ON and the data is held for the data output time.

- 1** The Sensor Controller outputs data when execution of the Fieldbus Data Output Unit is started.
- 2** Data is output every time the Fieldbus Data Output Unit or another Fieldbus Data Output Unit is executed. The previously output data is overwritten.

IMPORTANT

- To receive all the output data, set [Output control] to [Handshaking], and then output data.
(Refer to ► *Set the EtherNet/IP Output Specifications* (p.225), and *Output Format (Fieldbus Data Output)* (p.235))
- If any part of data is missing on the PLC side, or the GATE signal and the BUSY signal is not output from the FH Sensor Controller, set [Measurement priority] to [Lower the priority of the measurement process.]. Note that the measurement time becomes longer with this setting.
(Refer to ► *Setting the Status at Startup [Startup Settings]* in the *Vision System FH/FZ5 Series User's Manual* (Cat. No. Z365))

Using Handshaking

When the PLC (user) turns ON the Result Set Request (DSA) signal, the Result Completion (GATE) signal turns ON.

At that point, the output data that can be output*1 is output.

The PLC (user) turns OFF the DSA signal when it has received the output data and when the Result Completion (GATE) signal is ON.

If data is output from more than one Fieldbus Data Output Unit, turn ON the DSA signal again after the Sensor Controller turns OFF the Result Completion (GATE) signal to output the next output data.

*1: This is the data that is prepared for output when the Output Unit is executed in the measurement flow.

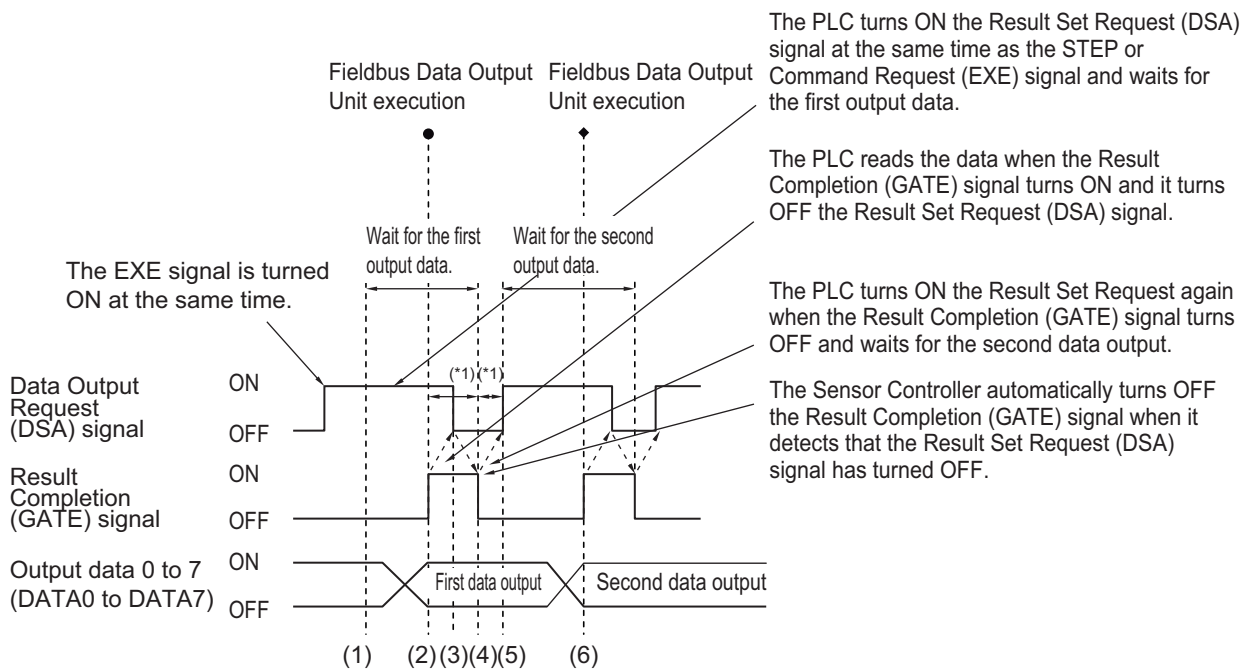

*1 A timeout error will occur if any of the following states continues for longer than the timeout time that is set in the EtherNet/IP settings.

- If the DSA signal is not turned ON after a certain time elapses from when the Output Unit was executed. (Turn ON the DSA signal at the same time as the measurement trigger command.)
- If the DSA signal is not turned OFF after a certain time elapses from when the GATE signal turns ON.

- 1** The PLC (user) turns ON the Command Request (EXE) signal and the Result Set Request (DSA) signal at the same time. The output data for the first Fieldbus Data Output Unit can be dependably received.
- 2** The Sensor Controller executes the Fieldbus Data Output Unit in the measurement flow. Because the Result Set Request (DSA) signal is ON after the data is written, the Result Completion (GATE) signal turns ON.
- 3** The PLC (user) reads the data when the Result Completion (GATE) signal turns ON and it turns OFF the Result Set Request (DSA) signal.
- 4** The Sensor Controller automatically turns OFF the Result Completion (GATE) signal when it detects that the Result Set Request (DSA) signal has turned OFF.
- 5** If there is more than one Field Data Output Unit in the measurement flow, the PLC (user) turns ON the Result Set Request (DSA) signal when the Result Completion (GATE) signal turns OFF and then waits for execution of the next Field Data Output Unit.
- 6** When the next Fieldbus Data Output Unit is executed, the GATE signal turns ON and the data is output. Receive the second output data and then repeat steps 3 to 5, above. Repeat steps 3 to 5 for any other data outputs.

Time Charts

The ON/OFF timing of signals related to the sequence of operation from control command input until data output after completion of measurement is indicated in the timing chart below.

Example 1: Inputting a Measurement Trigger after Changing a Scene without Handshaking

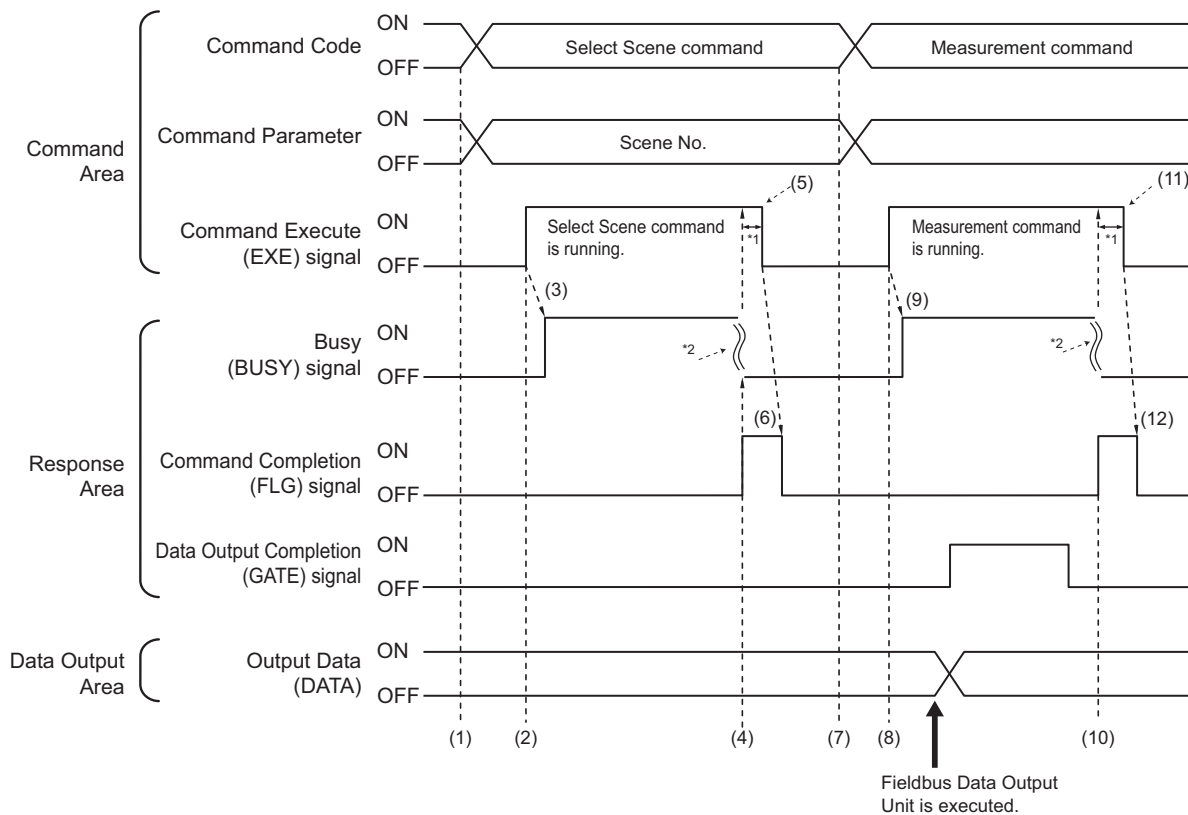

*1: A timeout error will occur if you do not turn off the Command Execution (EXE) signal from Sensor Controller (master) within 10 seconds. Then Command Completion (FLG) signal and Busy (BUSY) signal will be forced to turn off.

*2: Busy (BUSY) signal is automatically switched ON to OFF when the command execution is completed.

- 1** The command code and command parameters for the Select Scene command are set from the PLC.
- 2** Next, confirm that the BUSY signal and the Command Completion (FLG) signal have turned OFF and then turn ON the Command Request (EXE) signal again. A request is sent to the Sensor Controller.
- 3** The Sensor Controller changes the scene and turns ON the BUSY signal when the request is received.
- 4** Command Completion (FLG) signal is turned ON after Scene Selection is finished.
- 5** The PLC (user) switches the Command Request (EXE) signal back to OFF when the Command Completion (FLG) signal turns ON.
- 6** The Sensor Controller checks that the Command Request (EXE) signal is OFF, then automatically turns the Command Completion (FLG) signal.
- 7** The measurement command code and command parameters are set from the PLC.
- 8** The Command Request (EXE) signal is turned ON to execute the measurement command.

Note

To execute a measurement trigger after changing the scene, first confirm that the Command Completion (FLG) signal and the Busy (BUSY) signal that turned ON for execution of the Select Scene command have turned OFF. Also, if the Busy (BUSY) signal is ON for too little time and the external device cannot read it, increase the time that the Busy (BUSY) signal is ON for changing scenes so that the external device can read the ON state. To do this, change the [Add time] setting for the [Scene switch time]. Refer to ► *Setting the Conditions That Are Related to Operation during Measurement* in the *Vision System FH/FZ5 Series User's Manual* (Cat. No. Z365).

- 9** The Sensor Controller executes measurement processing and turns ON the BUSY signal when the request is received.
- 10** Command Completion (FLG) signal turns ON when the measurement processing is completed.
- 11** The PLC (user) turns OFF the Command Request (EXE) signal when the Command Completion (FLG) signal turns ON.
- 12** When the Sensor Controller detects that the Command Request (EXE) signal is OFF, it automatically turns OFF the Command Completion (FLG) signal.

Example 2: Outputting Data with More Than One Output Unit without Handshaking

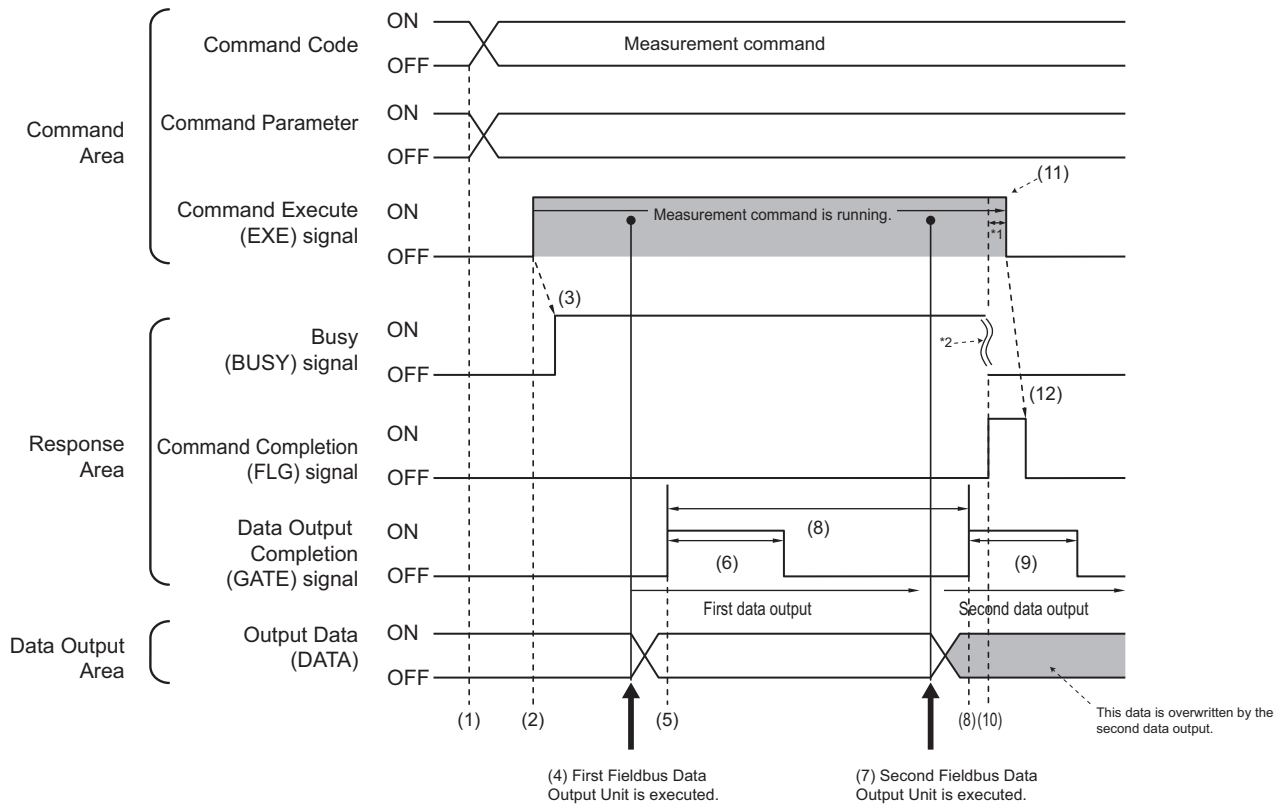

*1: A timeout error will occur if you do not turn off the Command Execution (EXE) signal from Sensor Controller (master) within 10 seconds. Then Command Completion (FLG) signal and Busy (BUSY) signal will be forced to turn off.

*2: Busy (BUSY) signal is automatically switched ON to OFF when the command execution is completed.

- 1** The measurement command code and command parameters are set from the PLC.
- 2** Next, confirm that the BUSY signal and the Command Completion (FLG) signal have turned OFF and then turn ON the Command Request (EXE) signal again. A request is sent to the Sensor Controller.
- 3** The Sensor Controller executes measurement processing and turns ON the BUSY signal when the request is received.
- 4** When the first Fieldbus Data Output Unit in the measurement flow is executed, the Sensor Controller outputs the output data for the first Fieldbus Data Output Unit to the Data Output Area.
- 5** The Sensor Controller turns ON the Result Completion (GATE) signal when it has output the output data to the Data Output Area.
- 6** The Sensor Controller turns OFF the Result Completion (GATE) signal after the output time set in the EtherNet/IP settings has elapsed.
- 7** The second Fieldbus Data Output Unit in the measurement flow is executed.
- 8** When the time that is set for the output period in the EtherNet/IP settings has elapsed, the Sensor Controller outputs the output data for the second Fieldbus Data Output Unit to the Data Output Area.
The data for the first Fieldbus Data Output Unit is overwritten at that time.
- 9** The Sensor Controller turns ON the Result Completion (GATE) signal and then turns it OFF after the output time that is set in the EtherNet/IP settings has elapsed.

- 10** The BUSY signal turns off and the Command Completion (FLG) signal turns ON when the measurement processing is completed.
- 11** The PLC (user) turns OFF the Command Request (EXE) signal when the Command Completion (FLG) signal turns ON.
- 12** The Sensor Controller confirms that the Command Request (EXE) signal is OFF and automatically turns OFF the Command Completion (FLG) signal.

Note**Saving All of the Measurement Results**

If you output data from more than one Data Output Unit or for repeatedly measured output data (e.g., for continuous measurements), the same Data Output Area will be overwritten.

To save all of the output data, adjust the output period and output time that are set in the EtherNet/IP settings so that all of the output data is output and either receive all of the output data by using the Result Completion (GATE) signal or use handshaking control.

Handshaking lets you control data output by using the GATE signal turning ON as a trigger for the data output timing and turning ON the DSA to read the output data. (This is necessary from the second output data item onward.)

Each time that data is output, read the output data and move it to a different part of I/O memory in the PLC.

Refer to ► Data Output Control with Handshaking (p.32) for details on handshaking.

You can compare the received number of output data and the number of measurements for continuous measurements to check if all of the measurement results have been received.

Use the following method to check the number of measurements that was actually executed.

- Application Example

Set a calculation to count the number of measurements that are executed in the measurement flow.

If you set something like [DO+1], each time a measurement is executed (each time the measurement flow is executed), 1 will be added to DO, so the present value of DO will give you the actual number of measurements.

Communicating with the Sensor Controller with EtherNet/IP Message Communications

Message communications are used when communicating with a PLC that does not support tag data link communications or when using functions, such as character string output, that are not supported in tag data link communications.

Message communications can be performed either by exchanging the same data as for tag data link communications using assembly objects or by sending and receiving commands equivalent to non-procedure commands using Sensor Controller-specific Vision Sensor objects.

This document mainly describes the assembly objects and Sensor Controller-specific Vision Sensor objects. For information on the procedures for sending messages, refer to the manuals for the PLC you are using.

Object Configuration

The Sensor Controller's EtherNet/IP function supports the following objects. These objects can be accessed using message communications.

Class (object name)	Class ID	Instance ID
Identity Object	1 (01 hex)	1 (01 hex)
Message Router Object	2 (02 hex)	1 (01 hex)
Assembly Object	4 (04 hex)	100 (64 hex): Output connection (for normal control and for line 0 in the Multi-line Random Trigger Mode)
		101 (65 hex): Input connection (for line 1 in the Multi-line Random Trigger Mode)
		102 (66 hex): Output connection (for normal control and for line 0 in the Multi-line Random Trigger Mode)
		103 (67 hex): Input connection (for line 1 in the Multi-line Random Trigger Mode)
Connection Manager Object	6 (06 hex)	1 (01 hex)
Vision Sensor Object	100 (64 hex)	1 (01 hex): For normal control and for line 0 in the Multi-line Random Trigger Mode
		2 (02 hex): For line 1 in the Multi-line Random Trigger Mode
		3 (03 hex): For line 2 in the Multi-line Random Trigger Mode
		4 (04 hex): For line 3 in the Multi-line Random Trigger Mode
		5 (05 hex): For line 4 in the Multi-line Random Trigger Mode
		6 (06 hex): For line 5 in the Multi-line Random Trigger Mode
		7 (07 hex): For line 6 in the Multi-line Random Trigger Mode
		8 (08 hex): For line 7 in the Multi-line Random Trigger Mode
TCP/IP Interface Object	245 (F5 hex)	1 (01 hex)
EtherNet Link Object	246 (F6 hex)	1 (01 hex)

Data Types

The data types are preset as follows in the EtherNet/IP specifications.

Data type	Description	Range	
		Minimum value	Maximum value
BOOL	Boolean	0: FALSE	1: TRUE
SINT	Short integer	-128	127
INT	Integer	-32768	32767
DINT	Double-precision integer	-2^{31}	$2^{31}-1$
USINT	Unsigned short integer	0	255
UINT	Unsigned integer	0	65535
UDINT	Unsigned double-precision integer	0	$2^{32}-1$
BYTE	Bit string: 8 bits	---	---
WORD	Bit string: 16 bits	---	---
DWORD	Bit string: 32 bits	---	---
REAL	Floating-point real	Single-precision floating-point range	

Note

All values are stored in little endian order.

Class ID: 4 Assembly Object

This object is used when communicating with a PLC that does not support tag data link communications.

Settings for Data Received by the Sensor Controller

Instance

Setting item	Set value	Description
Instance	100	For normal control and for line 0 in the Multi-line Random Trigger Mode
	102	For line 1 in the Multi-line Random Trigger Mode
	104	For line 2 in the Multi-line Random Trigger Mode
	106	For line 3 in the Multi-line Random Trigger Mode
	108	For line 4 in the Multi-line Random Trigger Mode
	110	For line 5 in the Multi-line Random Trigger Mode
	112	For line 6 in the Multi-line Random Trigger Mode
	114	For line 7 in the Multi-line Random Trigger Mode

Attribute

Attribute ID	Access	Name	Data type	Description
0x03	Set	Data	BYTE array	The command that was received by the Sensor Controller is set in this attribute. The format is the same as for an output connection in tag data link communications. Reference: ► Input Connection to Sensor (PLC Originator to Sensor Controller Target) (p.238)
0x04	Get	Size	UNIT	Number of bytes: 20

Service

Service code	Name	Description
14 (0E hex)	GetAttributeSingle	Gets the attribute value.
16 (10 hex)	SetAttributeSingle	Sets a value for the attribute. Whether an attribute can be set depends on the access attribute of the attribute.

Settings for Data Sent by the Sensor Controller

Instance

Setting item	Set value	Description
Instance	101	For normal control and for line 0 in the Multi-line Random Trigger Mode
	103	For line 1 in the Multi-line Random Trigger Mode
	105	For line 2 in the Multi-line Random Trigger Mode
	107	For line 3 in the Multi-line Random Trigger Mode
	109	For line 4 in the Multi-line Random Trigger Mode
	111	For line 5 in the Multi-line Random Trigger Mode
	113	For line 6 in the Multi-line Random Trigger Mode
	115	For line 7 in the Multi-line Random Trigger Mode

Attribute

Attribute ID	Access	Name	Data type	Description
0x03	Get	Data	BYTE array	This attribute contains the data that was sent by the Sensor Controller. The format is the same as for input connection in tag data link communications. Reference: ► Output Connection to PLC (Sensor Controller Originator to PLC Target) (p.240)
0x04	Get	Size	UNIT	Number of bytes: 48

Service

Service code	Name	Description
14 (0E hex)	GetAttributeSingle	Gets the attribute value.

ClassID:100 (64 hex) Vision Sensor Object

You can exchange character string data with a format equivalent to non-procedure commands with objects specific to the Sensor Controller. You can use this object, for example, to output character strings, which is not supported by tag data links.

Instance

Setting item	Set value	Description
Instance	1	For normal control and for line 0 in the Multi-line Random Trigger Mode
	2 to 8	For lines 1 to 7 in the Multi-line Random Trigger Mode

Attribute

Attribute ID	Access	Name	Data type	Description
0x01	Set	Data	BYTE array	The command string to send to the Sensor Controller is set in this attribute. (504 characters max.) The commands that can be used are equivalent to non-procedure commands. Reference: ► Command List (p.355)

Service

Service code	Name	Description
0x32	SetAttribute	Sets a value for the attribute.

Command Setting Example

This section describes how to set attribute command strings and provides a setting example.

- For the data that is sent from the PLC to the Sensor Controller, set a command character string equivalent to a non-procedure command. Attach 0x00 (null) at the end of the character string. No line feed code is required. The size of the send data includes the 0x00 at the end of the character string.
- For the reception data from the Sensor Controller to the PLC, character string data equivalent to the non-procedure command reception character string is returned.
Null (0x00) is inserted in the reception character string delimiter section.
The size of the reception data includes the final 0x00.

Example: Getting the Number (0) of the Current Scene

Send data (2 bytes): 0x53('S') 0x00

↓

Receive data (5 bytes): 0x30('0') 0x00 0x4f('O') 0x4b('K') 0x00

Note

To acquire data output from a processing unit, such as characters read in Character Inspection, use the external reference data for the processing unit.

Therefore, use the specified command which acquires the parameters or measurement value.

Reference: ► UNITDATA or UD (p.512)

For the external reference No. which is used in UNITDATA or UD function, refer to the description of each processing items.

EtherNet/IP Troubleshooting

Cannot Input to the Sensor Controller

Problem	Cause	Action
No input is received.	The EDS file version does not match the firmware version.	Make sure that the EDS file version matches the firmware version.

No Data Is Output from the Sensor Controller

Problem	Cause	Action
GATE signal is not output.	The RPI (packet interval) and the Sensor Controller's output period are not set correctly.	The RPI (packet interval) time must be set so that it is shorter than the output period.
There is absolutely no data output.	The EDS file version does not match the firmware version.	Make sure that the EDS file version matches the firmware version.
	Incorrect Communication is set.	Verify that Communication is set to EtherCAT.

A Timeout Error Occurred

Problem	Cause	Action
A handshaking timeout error occurred.	The timing of turning the DSA signal ON and OFF is too slow. One of the following problems may exist. <ul style="list-style-type: none"> • The DSA signal does not turn ON after a measurement is completed. • The DSA signal does not turn OFF after the GATE signal turns ON. • The DSA signal does not turn ON after the GATE signal turns OFF. 	After the measurement command is executed, turn the DSA signal ON and OFF within the timeout time ^{*1} that is set in the Ethernet/IP communications settings. Or, increase the length of the timeout time that is set in the EtherNet/IP settings.
A tag data link timeout error occurred.	Communication between an external device and the Sensor Controller has been temporarily interrupted. The Sensor Controller prioritizes measurement processing and control processing over communication processing. Therefore, when the Sensor Controller's internal processing load becomes large and sensor communication processing is delayed, communication between an external device and the Sensor Controller may be temporarily interrupted, and a communication error may occur.	Set the communication error timeout time longer than the Sensor Controller's processing time, or lengthen the measurement interval. Set the communication error timeout time in the tag data link connection settings (*1) as follows: Packet interval (RPI value) × Timeout value > Measurement time on Sensor Controller

Slow Operation

Problem	Cause	Action
Response and data output is slow.	You are performing communications with incompatible protocols (e.g., PLC Link and EtherNet/IP).	Do not use incompatible protocols for communications.

Settings are not kept

Problem	Cause	Action
Settings, such as Fieldbus Data Output Calculations, or Comments, are not being kept.	Changed the Communication settings after setting of Fieldbus Data Output.	Specify the Fieldbus Data Output settings after settings of Communication.

Non-procedure Communications

This section provides the communications settings, communications specifications, input formats, and other information required to perform non-procedure (normal) communications between the Sensor Controller and an external device.

Communications Processing Flow

The Sensor Controller and external device communicate with command-based non-procedure communications via Ethernet or RS-232C/422.

Communications are performed via the Ethernet using the UDP/IP or TCP/IP protocol.

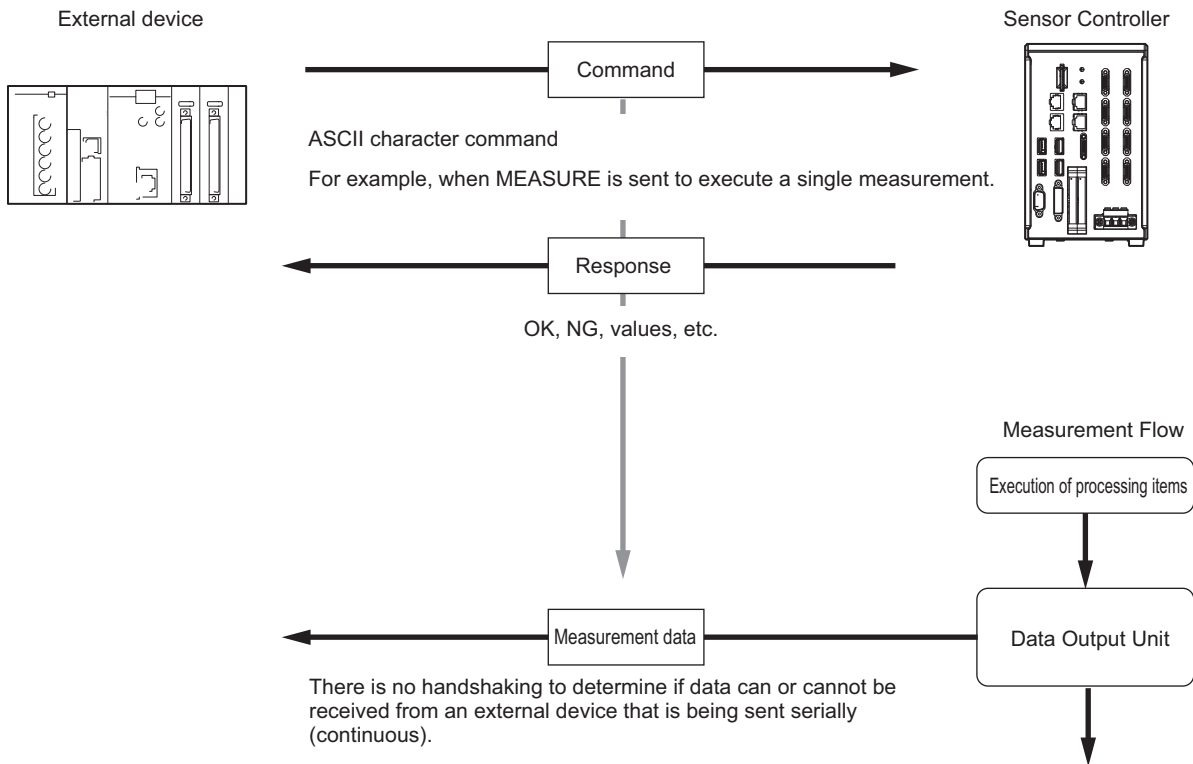

*1: If Xon/Xoff is selected for the flow control and no response is received from the computer within the set timeout interval, there must either be a disconnection or the computer is not functioning correctly, causing the communications to time out.

Communications Setup Procedures

The following settings are required to use non-procedure communications.

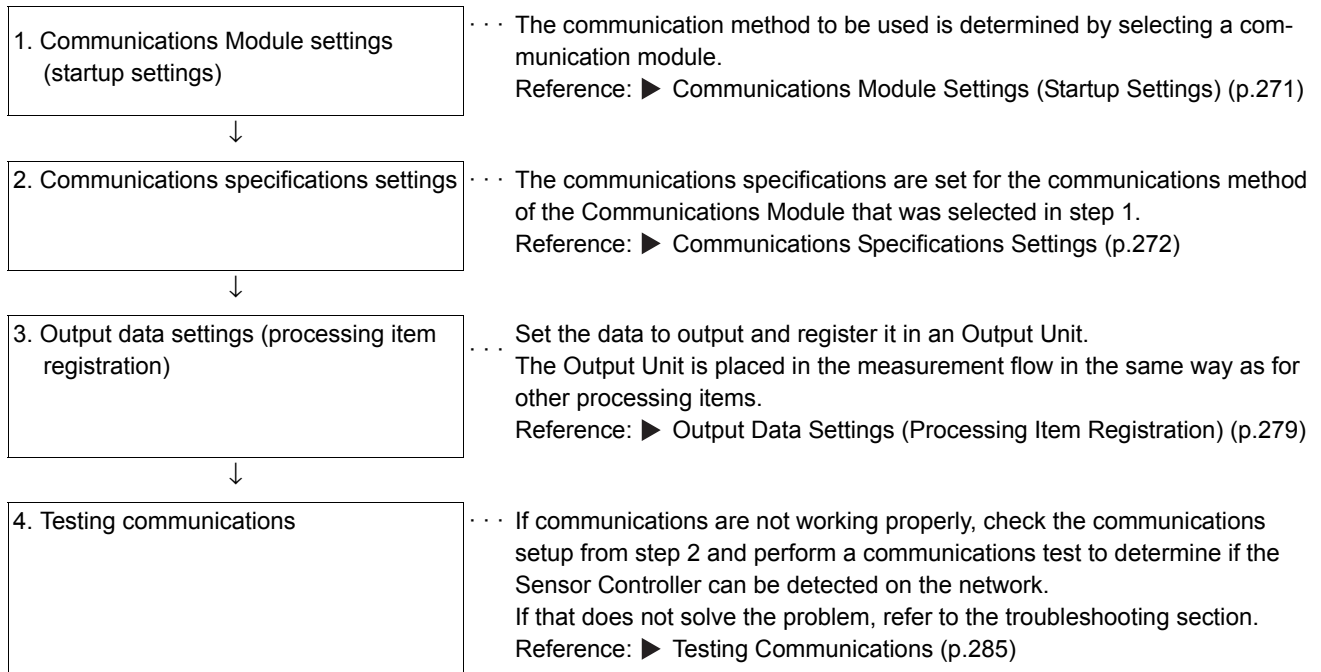

Communications Module Settings (Startup Settings)

The communication method used for communication with the Sensor Controller is selected from the communication modules.

- 1 On the Main Window, select [Tool] – [System Settings].
- 2 Select [System settings] – [Startup] – [Startup setting] on the Multiview Explorer on the left and then click [Communication].

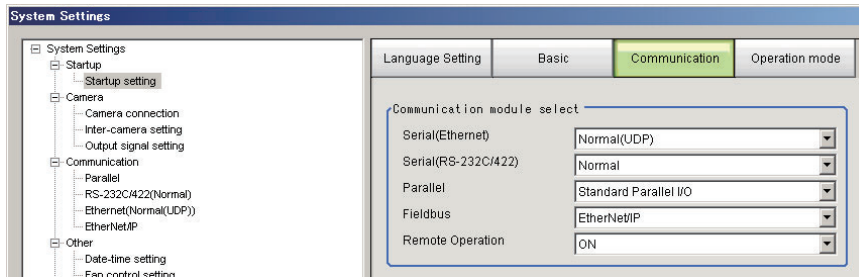

- 3 Select one of the following Communications Modules based on the communications method that is used to connect with the Sensor Controller and the Unit to connect to, then click [Apply].

Communications Module	Description
Serial (Ethernet)	Performs non-procedure communications through an Ethernet connection.
Normal (UDP)	Select this Communications Module to communicate with the external device with UDP communications.
Normal (TCP)	Select this Communications Module to communicate with the external device with TCP server communications.
Normal (TCP Client)	Select this Communications Module to communicate with the external device as a TCP client.
Normal (UDP) (Fxxx series method)	Select this Communications Module to communicate with the external device through UDP or Fxxx-series* ¹ communications.
Serial (RS-232C/422)	Normally select this Communications Module to use non-procedure communications through an RS-232C/422 connection.
Normal	Normally selected when performing non-procedure RS-232C/422 communications.
Normal (Fxxx series method)	Select this Communications Module to communicate with the external device through Fxxx-series* ¹ communications.

*1: With the [Normal (Fxxx series method)] communications method, the OK response timing in relation to MEASURE commands is different from that of the [Normal] communications method.
Reference: ► Command Formats (p.289)

- 4 Click the [Data save] button in the Toolbar.

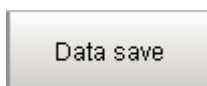

- 5 On the Main Window, select [Function] – [System restart].
Click [OK] in the [System restart] dialog box to restart the Sensor Controller.
- 6 When the Sensor Controller has restart, operation will be performed for the default settings of the specified Communications Module.

Set the IP address and other settings for the PLC or other external device.

IMPORTANT

After you set the Communications Module, always click [Data save] and then restart the Sensor Controller. If the settings are not saved and the Sensor Controller is not restarted, the new Communications Module settings will not be enabled.

Note

You can save the Communications Module settings to a file.

Select [Save to file] from the [Function] menu, and then select [System data] or [System + Scene group 0 data] to save the settings data to a file.

Refer to ► *Saving Settings Data to the Controller RAM Disk or an External Memory Device* in the *Vision System FH/FZ5 Series User's Manual* (Cat. No. Z365).

Communications Specifications Settings

The communications settings must be set separately for Ethernet and RS-232C communications.

If communications cannot be performed even after setting these communications settings, check the settings and the communications status.

Reference: ► Testing Communications (p.285)

IMPORTANT

- The settings dialog box for the communications specifications will change depending on the Communications Module that you use.
Before you set the communications specifications, select the Communications Module to use with the Sensor Controller in the startup settings.
Reference: ► Communications Module Settings (Startup Settings) (p.271)
After you select the Communications Module, save the settings to the Sensor Controller and restart the Sensor Controller. If you do not restart the Sensor Controller, the selected Communications Module will not be enabled.
- Use the same communications settings for the Sensor Controller and the external device.
- Do not input signals to Ethernet from an external device while setting the Ethernet system settings.
- If the operation mode is set to Multi-line Random-trigger Mode, the Controller address cannot be set for line 1 onward. (The same setting for line 0 is used.)

Connecting via Ethernet

- 1** On the Main Window, select [Tool] – [System Settings].
- 2** In the tree view on the left, select [System Settings] – [Communication] – [Ethernet Normal (xyz)]. (“xyz” depends on the Communications Module.)

The Ethernet View is displayed.

3 Set the following items.

UDP

Address setting				
<input type="radio"/> Obtain an IP address automatically				
<input checked="" type="radio"/> Use the following IP address				
IP address:	10	5	5	100
Subnet mask:	255	255	255	0
Default gateway:	10	5	5	100
DNS server:	10	5	5	100
Preferred WINS server:	0	0	0	0
Alternate WINS server:	0	0	0	0
Address setting 2				
<input type="radio"/> Obtain an IP address automatically				
<input checked="" type="radio"/> Use the following IP address				
IP address:	10	5	6	100
Subnet mask:	255	255	255	0
Default gateway:	10	5	6	100
DNS server:	10	5	6	100
Preferred WINS server:	0	0	0	0
Alternate WINS server:	0	0	0	0
Input/Output setting				
Input mode:	Normal			
Input form:	ASCII			
Output IP address:	0	0	0	0
Input port No.:	9600			
Output port No.:	-1 (-1: Same number Input port No)			

Note

- The following series with 4 or 8 camera inputs has two Ethernet ports:

- FH-1000 series
- FH-3000 series

Set the settings for the two Ethernet ports as follows:

- Communications Module settings
Use the same setting for both ports.
- IP address settings

Set a different IP address for each Ethernet port.

The IP address for the top Ethernet port is set in [Address setting], and the IP address for the bottom Ethernet port is set in [Address setting 2]. By using both Ethernet ports simultaneously, you can use one for PLC Link, non-procedure, Ethernet, or IP communications with a PLC and the other for FTP or remote operation communications with an external device.

- The following Sensor Controller type has one Ethernet port:

FH-L series

FH-1000/FH-3000 series with two camera inputs

In this case, the IP address of the Ethernet port is set in [Address setting 2].

- The FZ5 has only one Ethernet port.

In this case, the IP address of the Ethernet port is set in the [Address setting].

Setting item	Set value [Factory default]	Description
Address Settings Address Settings is only for the following series: <ul style="list-style-type: none"> • FH-1000 series (4, 8 camera type) • FH-3000 series (4, 8 camera type) • FZ5 series Sensor Controller 		
	<ul style="list-style-type: none"> • Obtain an IP address automatically • [Use the following IP address] 	Set the IP address of the top Ethernet port on the Sensor Controller. Set the IP address of the Sensor Controller. When [Obtain an IP address automatically] is selected, the IP address of the Sensor Controller will be automatically obtained. When [Use the following IP address] is selected, set the IP address, subnet mask, and the default gateway address.
IP address	a.b.c.d a: 1 to 223 b: 0 to 255 c: 0 to 255 d: 2 to 254 [10.5.5.100]	Input the IP address of the Sensor Controller.
Subnet mask	0.0.0.0 to 255.255.255.255 [255.255.255.0]	Input the subnet mask address.
Default gateway	a.b.c.d a: 1 to 223 b: 0 to 255 c: 0 to 255 d: 0 to 255 [10.5.5.100]	Input the default gateway address.
DNS server	a.b.c.d a: 1 to 223 b: 0 to 255 c: 0 to 255 d: 0 to 255 [10.5.5.100]	Input the DNS server address.
Preferred WINS server	a.b.c.d a: 1 to 223 b: 0 to 255 c: 0 to 255 d: 0 to 255 [0.0.0.0.]	Inputs address of WINS server.
Alternate WINS server	a.b.c.d a: 1 to 223 b: 0 to 255 c: 0 to 255 d: 0 to 255 [0.0.0.0]	Inputs address of WINS server.

Setting item	Set value [Factory default]	Description	
Address setting 2 Address Settings is only for the following series: <ul style="list-style-type: none"> • FH-1000 series (2 camera type) • FH-3000 series (2 camera type) • FH-L series Sensor Controller 		Set the IP address of the bottom Ethernet port on the Sensor Controller.	
<ul style="list-style-type: none"> • Obtain an IP address automatically • [Use the following IP address] 			
IP address	a.b.c.d a: 1 to 223 b: 0 to 255 c: 0 to 255 d: 2 to 254 [10.5.6.100]		
Subnet mask	0.0.0.0 to 255.255.255.255 [255.255.255.0]		
Default gateway	a.b.c.d a: 1 to 223 b: 0 to 255 c: 0 to 255 d: 0 to 255 [10.5.6.100]		Same as [Address setting].
DNS server	a.b.c.d a: 1 to 223 b: 0 to 255 c: 0 to 255 d: 0 to 255 [10.5.6.100]		
Preferred WINS server	a.b.c.d a: 1 to 223 b: 0 to 255 c: 0 to 255 d: 0 to 255 [0.0.0.0.]		Inputs address of WINS server.
Alternate WINS server	a.b.c.d a: 1 to 223 b: 0 to 255 c: 0 to 255 d: 0 to 255 [0.0.0.0]	Inputs address of WINS server.	

Setting item		Set value [Factory default]	Description
Input/Output setting			
Input mode		[Normal]	This item cannot be changed.
Input form		[ASCII]	This item cannot be changed.
UDP	Output IP address	a.b.c.d a: 0 to 255 b: 0 to 255 c: 0 to 255 d: 1 to 254 [0.0.0.0]	Input the output destination IP address.
	Input port No.	0 to 65535 [9600]	Set the port No. to use for data input with the Sensor Controller. Set the same number as on the host side.
	Output port No.	0 to 65535 [-1]*1 *1: When using the same port as the input port.	Set the port No. to use for data output with the Sensor Controller. Set the same number as on the host side.
TCP	Input/Output port No.	0 to 65535 [9876]	Sets the port number used input and output data connected with the Sensor Controller. Set the same number as on the host side.
TCP Client	TCP Server	a.b.c.d a: 0 to 255 b: 0 to 255 c: 0 to 255 d: 0 to 255 [10.5.5.101]	Input the connection destination IP address.
	Input/Output port No.	0 to 65535 [9876]	Set the port No. to use for data I/O with the Sensor Controller. Set the same number as on the host side.

IMPORTANT

- If the operation mode is set to Multi-line Random-trigger Mode, set a different I/O port number for each line.
- Change the IP address and subnet mask for [Address setting] and [Address setting 2] as required so that each designate a different network address. If the same network address is specified, communications may not be performed correctly.
- Be sure to change the output IP address from its factory default value in accordance with your network environment.

4 Click [Apply] to apply the settings.

Click [Close] to close the System Settings Dialog Box .

Note

- Input signals cannot be handled during setting of communications specifications. However, the input status can be checked with [Confirmation].
Reference: ► Testing Communications (p.285)
- Data output via serial communications is suspended while communications specifications are being set.

- 1** On the Main Window, select [Tool] – [System Settings].
- 2** From the tree view on the left, select [System Settings] and then select [Communication] – [RS-232C/422 (Normal)] or [RS-232C/422 (Normal (Fxxx series method))].

The RS-232C window is displayed.

- 3** Set the following items.

Setting	Confirmation
Mode :	Normal
Interface :	RS-232C
Baud rate [bps] :	38400
Data length [bit] :	8
Parity :	None
Stop bit [bit] :	1
Flow control :	None
Delimiter :	CR
Timeout [s] :	5 ...

Setting item	Set value [Factory default]	Description
Interface	<ul style="list-style-type: none"> • [RS-232C] • RS-422^{*1} 	Use the same communications specifications as the external device.
Baud rate [bps] ^{*2}	<ul style="list-style-type: none"> • 2400 • 4800 • 9600 • 19200 • [38400] • 57600 • 115200 	Use the same communications specifications as the external device.

Setting item	Set value [Factory default]	Description
Data length [bit]	<ul style="list-style-type: none"> • 7 • [8] 	Use the same communications specifications as the external device.
Parity	<ul style="list-style-type: none"> • [None] • Odd • Even 	
Stop bit [bits]	<ul style="list-style-type: none"> • [1] • 2 	
Flow control	[None]	Flow control is not performed with software. If the time in which there is no response from external devices reaches the timeout setting time, a timeout error occurs and an error message is displayed in the window. The parallel interface ERROR signal also turns ON.
	Xon/Xoff	Flow control is performed with software. Data is sent according to the Xon/Xoff codes from external devices.
Timeout [s]	1 to 120 [5]	Set the time in which a timeout error will occur.
Delimiter	<ul style="list-style-type: none"> • [CR] • LF • CR+LF 	Use the same communications specifications as the external device.

*1: RS-422 cannot be used with the MELSEC-Q series and the FH-series.

*2: If a baud rate of [38400 bps] or higher is selected, effective communications may not be possible depending on the cable length because speeds of over 20 Kbps are not defined in RS-232C standards. In this case, set the baud rate to [19200 bps] or lower.

4 Click [Apply] to apply the settings.

Click [Close] to close the System Settings Dialog Box .

Output Data Settings (Processing Item Registration)

Use the following procedures to set the items to output and the output format for the non-procedure protocol.

Note

When outputting characters read by a processing item such as Barcode, these settings are set in the processing item used to read the characters (Character Inspection, Barcode, or 2DCode).

Refer to the descriptions for each processing item for details on the character output settings and output format.

- Reference: ► *Character Inspection* in the *Vision System FH/FZ5 Series Processing Item Function Reference Manual* (Cat. No. Z341)
- Reference: ► *Barcode* in the *Vision System FH/FZ5 Series Processing Item Function Reference Manual* (Cat. No. Z341)
- Reference: ► *2DCode* in the *Vision System FH/FZ5 Series Processing Item Function Reference Manual* (Cat. No. Z341)

Registering Processing Items

Register the processing items for data output in the measurement flow.

- 1 Click [Edit flow] in Toolbar.
- 2 Click [Data Output] in the processing item tree.

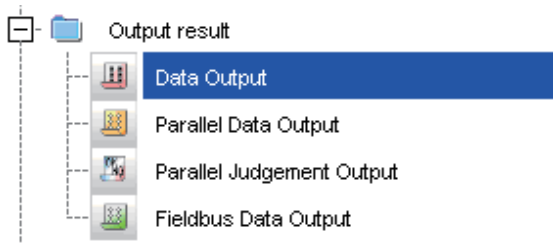

- 3 Click [Append].

The [Data Output] processing item is appended at the bottom of the unit list (flow).

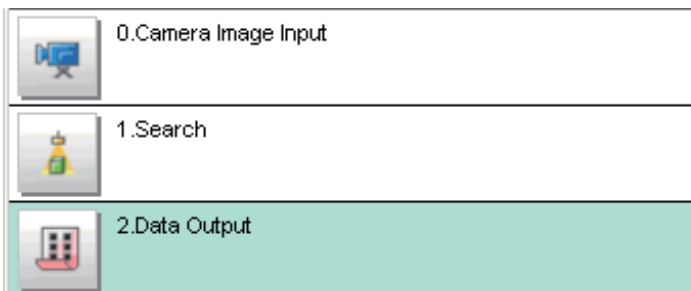

- 4 Click the [Data Output] icon () and set the data output items and data format.

Refer to the following reference for details on the settings.

Reference: ► Registering the Items To Output (p.280)

Note

- Data is output in the order that data output is registered in the measurement flow, i.e., the timing is different for each data output processing item. (Data output is executed in the order that it is executed in the measurement flow.) Reference: ► Outputting the Output Data (p.27)

Registering the Items To Output

Set expressions for the data to output.

Up to 8 expressions from 0 to 7 can be set in each unit.

- 1 Click the [Data Output] icon () in the measurement unit list (flow).
- 2 In the Item Tab Area, click [Setting].
- 3 In the list, select the output data number for the expression to set.

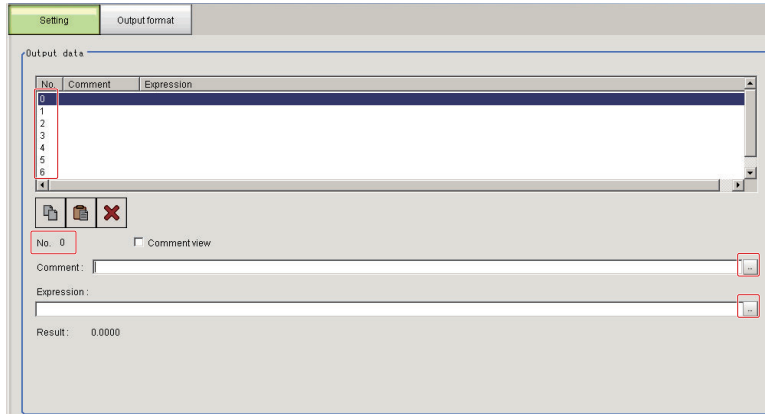

The selected output data number is displayed under the list.

- 4 Click the [...] button next to the expression box and set the expression.



Specify the processing items, measurement results, and measurement data in the expression. You can also perform arithmetic or function calculations on the measurement data before it is output.

For calculation settings, refer to section of Calculation in *FH/FZ5 Processing Item Function Reference Manual* (Cat. No. Z341).

- 5 Click the [...] button for the [Comment] box and enter an explanation of the expression.

The comment you enter will be displayed in the detailed results on the Main Window.

For example, if you enter "Test" as the comment for expression 0, "Test" will be displayed in place of "Expression 0" in the detailed results area on the Main Window.

- 6 Repeat steps 4 and 5 to set expressions for all of the required output data numbers.

Note

If you delete one of the expressions that is set for output data 0 through 7, the output numbers for all expressions after the deleted expression will stay the same. However, the actual data output will be output as though the list has been shifted forward for the number of expressions that have been deleted.

Example: If the Expression for Output 1 Is Deleted

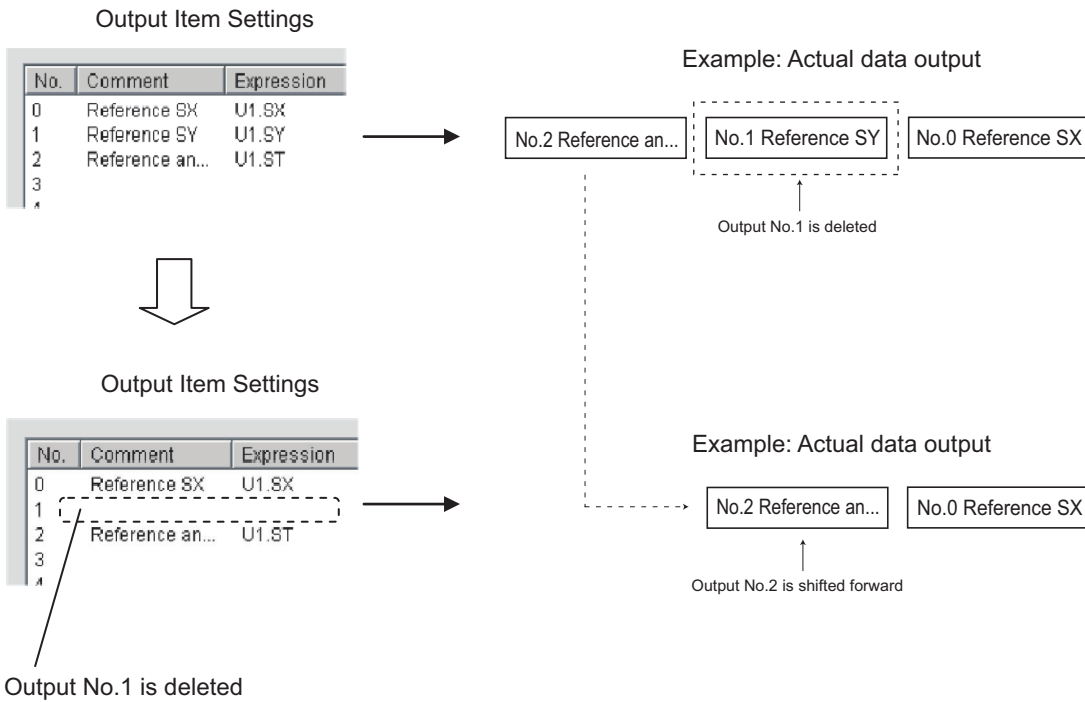

Output Format (Data Output)

- 1 Click the [Data Output] icon () in the measurement unit list (flow).
- 2 In the Item Tab Area, click [Output format].
- 3 In the Output Setting Area, select the communications method.

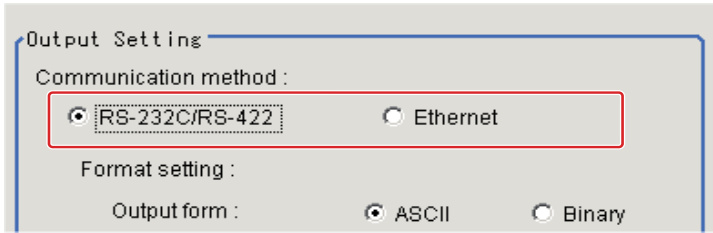

Set value [Factory default]	Description
[RS-232C/RS-422]	Communications are performed via a RS-232C/RS-422 connection.
Ethernet	Communications are performed via the Ethernet.

- 4 Select the output format in [Format setting].

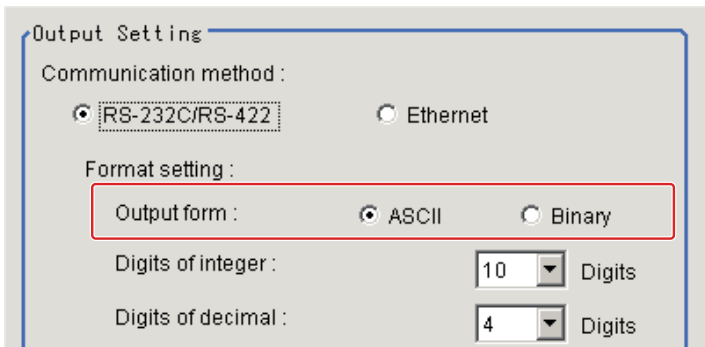

Set value [Factory default]	Description
[ASCII]	Outputs ASCII text. Refer to ► <i>Character Code Table</i> in the <i>Vision System FH/FZ5 Series User's Manual</i> (Cat. No. Z365).
Binary	Outputs binary data. Measurement values are multiplied by 1,000 and output is continuous with 4 bytes per data item.

• When the [ASCII] Output Format Is Selected

When [ASCII] is set as the output format, set the following format settings.

When [Binary] is set as the output format, no settings are needed.

Output Setting

Communication method :
 RS-232C/RS-422 Ethernet

Format setting :
 Output form : ASCII Binary

Digits of integer : Digits

Digits of decimal : Digits

Minus : - 8

Plus : None +

0 suppress : Available None

Field separator :

Record separator :

Setting item	Set value [Factory default]	Description
Digits of integer	0 to [10]	Specify the digits of the integer part including the sign. For positive numbers, the plus sign is not output. Example: Setting: 4 digits, Data: -5619 "-999" would be output.
Digits of decimal	0 to [4]	Specify the number of output digits in the decimal part. Lower decimal digits are rounded up before the data is output. When 0 is selected, the decimal digits will be rounded off.
Minus	<ul style="list-style-type: none"> • [-] • 8 	Select what is displayed in the sign digit for a negative number.
Plus	<ul style="list-style-type: none"> • [none] • + 	Select what is displayed in the sign digit for a positive number.
0 suppress	<ul style="list-style-type: none"> • Available • [OFF] 	Select the method for adjusting when there is a blank to the left of the output data. Available: Insert 0 into the blank digits. OFF: Insert a space for unused character. Example: If the integer section is set to 5 digits and the decimal section is set to 3 digits, the data is 100.000 Available: 00100.000 OFF: _100.000 (_ represents a space)
Field separator	<ul style="list-style-type: none"> • OFF • [Comma] • Tab • Space • Delimiter 	Select the separator for output data. *1: The delimiter is obtained from the system.
Record separator	<ul style="list-style-type: none"> • OFF • Comma • Tab • Space • [Delimiter] 	Select the separator for each time data is output. *1: The delimiter is obtained from the system.

5 If you have selected [Ethernet] for the [Communication method], perform the Ethernet settings.

Output Setting

Communication method :

RS-232C/RS-422 Ethernet

Format setting :

Output form : ASCII Binary

Digits of integer : Digits

Digits of decimal : Digits

Minus : - 8

Plus : None +

0 suppress : Available None

Field separator :

Record separator :

Output IP address setting :

Refer System(Ethernet)

The following IP address

Output IP address :

Set value [Factory default]	Description
[Refer System (Ethernet)]	The settings of the Ethernet View are applied. One of the following Ethernet Views is used to make the settings. PLC Link Communications Settings Reference: ► Communications Specifications Settings (p.166) Ethernet Non-procedure Communications Settings Reference: ► Communications Specifications Settings (p.272)
The following IP address	
Output IP addresses	Enter the output IP address.

Testing Communications

You can check whether the EtherNet/IP communications settings are correct.

If communications cannot be performed even after set up the communications, use the following procedure to check the settings and the communications status.

Ethernet Communications

Before Performing a Communications Test

This example assumes that [Normal (UDP)] is selected as the Communications Module.

Stop the program on the PLC when you check the communications settings.

Checking the Communications Settings

Use the following procedure to check if the communications settings are correct.

The screenshot shows a configuration window with three main sections:

- Address setting:** Includes radio buttons for "Obtain an IP address automatically" and "Use the following IP address". The latter is selected. Fields for IP address (10.5.5.100), Subnet mask (255.255.255.0), and Default gateway (10.5.5.100) are highlighted with a red box.
- Address setting 2:** Similar to the first section, with IP address (10.5.6.100), Subnet mask (255.255.255.0), and Default gateway (10.5.6.100) highlighted with a red box.
- Input/Output setting:** Shows "Input mode: Normal" and "Input form: ASCII". The "Output IP address" field (0.0.0.0) and "Output port No." field (9600) are highlighted with a red box. The "Output port No." field has a note: "(-1: Same number Input port No)".

1. On the Main Window, select [Tool] – [System Settings].
In the tree view on the left, select [System Settings] – [Communication] – [Ethernet Normal (xyz)]. (“xyz” depends on the Communications Module.)
2. Set the IP address of the Sensor Controller.
The default settings are as follows:
Address setting: 10.5.5.100
Address setting 2: 10.5.6.100
3. Set the IP address of the PLC or other external device in [Output IP address].
4. Set the port numbers to use for data I/O with the PLC or other external device in [Input port No.] and [Output port No.].
Set the same number as the number for the PLC or other external device.
5. This completes the Controller settings.

Checking the Communications Status

Use the ping command to check if the Sensor Controller exists on the Ethernet network.

Use this to determine if the Sensor Controller’s IP address has been set correctly and that the Sensor Controller is correctly connected to the Ethernet network.

Note

The ping command uses the ICMP protocol to send a response request to a device connected through an Ethernet network and determines the time required to respond to that request.

If you properly receive a response from the destination device, the network connection and network settings are correctly set.

1 Connect the Sensor Controller and computer with an Ethernet cable.

Set the left segments of IP address of the computer to the same values as the Controller and set only the right segment to a different value.

IP Address Setting Example

Device	Setting example
Sensor Controller	10.5.5.100 (default)
Computer	10.5.5.101

2 Open the Windows command prompt on the computer and execute the ping command.

At the ">" prompt, type "ping", followed by a space and the IP address of the Controller, and then press Enter.

Example:

```
C:\>ping 10.5.5.100
```

3 After a few seconds, if you see "Reply from" followed by the IP address of the Controller (e.g., 10.5.5.100), you will know that the Controller is connected to the Ethernet network.

Example:

```
Reply from 10.5.5.100: byte=32  
time<1ms TTL=128
```

If Anything Other than "Reply from" Is Displayed

This means that the Controller is not connected to the network for some reason. Check the following.

- Are the left three segments of the IP addresses of the computer and the Controller the same?
- Is the Ethernet cable connected?

4 Use the ping command to also check the communications status of the PLC.

After you have confirmed the communications status as described above, send an actual measurement command to the Controller and check to confirm that Vision Sensor communications are operating correctly.

Note that you might not get all data, depending on your environment.
(Network environment, PCs spec, or software which gets the data.)

Before Performing a Communications Test

This example assumes that [Serial (RS-232C/422)] – [Normal] or [Normal (Fxxx series method)] is selected as the Communications Module.

Stop the program on the PLC when you check the communications settings.

Checking the Communications Settings

Use the following procedure to check if the communications settings are correct.

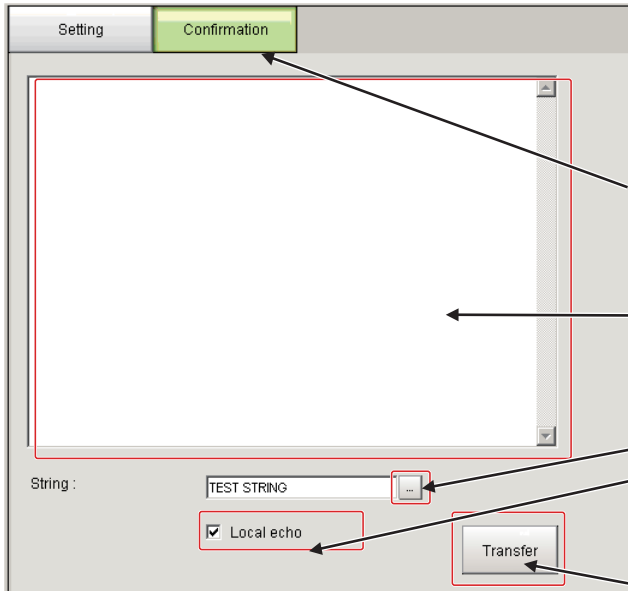

1. On the Main Window, select [Tool] – [System Settings].
From the tree view on the left, select [System Settings] and then select [Communication] – [RS-232C/422 (Normal)] or [RS-232C/422 (Normal (Fxxx series method))].
 2. Click the [Confirmation] tab.
- Reception Confirmation:
3. Send an ASCII character string to the Sensor Controller from the PLC or other external device.
 4. The command received from the PLC or other external device will be displayed here, following [Receive].
- Transmission Confirmation:
5. Click the button to the right of [TEST STRING].
 6. Enter the character string (12 characters or less) that you want to send to test communications. Select [Local echo] if you want to perform an echo check of the sent character string.
 7. Click the [Transfer] button to send the input character string to the PLC or other external device.
 8. If [Local echo] was selected, the character string that was sent will be displayed after [Send].
 9. Confirm that the character string was received by the PLC or other external device.

If the character string was not sent or received, check the following:

- Are the communications settings correct for the connected device?
- Is the cable connected?
- Are all cables wired correctly?

After you have confirmed the communications status as described above, send an actual measurement command to the Controller and check to confirm that Vision Sensor communications are operating correctly.

Output Items

Measurement Results That You Can Output with the Data Output Processing Item

You can use the processing items that are related to outputting results to output the following data. You can also access measured values from the Calculation or other processing units.

Measured item	Text string	Description
Judgement	JG	Judgement result
Data 0 to 7	D00 to D07	Results of expressions set for output data 0 to 7

External Reference Table for the Data Output Processing Item

By specifying a number, the following data can be referenced from control commands or processing items that have a set/get unit data function.

Number	Data name	Set/Get	Data range
0	Judgement	Get only	0: No judgement (unmeasured) 1: Judgement result OK -1: Judgement result NG
136	Communications method	Set/Get	0: Ethernet 1: RS-232C/RS-422
137	Output format	Set/Get	0: ASCII, 1: Binary
138	Digits of integer	Set/Get	1 to 10
139	Digits of decimal	Set/Get	0: 0 to 4:4
140	Minus	Set/Get	0: -, 1:8
141	Field separator	Set/Get	0: OFF, 1: Comma, 2: Tab, 3: Space 4: Delimiter
142	Record separator	Set/Get	0: OFF, 1: Comma, 2: Tab, 3: Space 4: Delimiter
143	0 suppress	Set/Get	0: No, 1: Yes
144 to 147	Output IP Address 1 to 4 (only when Ethernet is selected for the communications method)	Set/Get	Destination IP addresses
149	Output IP Address Setting (only when Ethernet is selected for the communications method)	Set/Get	0: Reference to system, 1: Individual specification
150	Output form (decimal)	Set/Get	0: Fixed point, 1: Floating point
151	Offset	Set/Get	0 to 99999
152	Number of output data items (PLC Link communications only)	Set/Get	8 to 256
153	Plus	Set/Get	0: No, 1: +
1000 to 1007	Data 0 to Data 7	Get only	• ASCII: -99999999.999 to 999999999.999 • Binary: -2147483.648 to 2147483.647

Note

If you are using external reference numbers 5 to 12 on an FZ4 or earlier model, use 1000 to 1007 on the FH/FZ5.

When a parameter is character string

The character string must be in double quotation marks.

Example: Save Scene with SCENESAVE command.

<Command Format>

SCNSAVE	0	"	C:\Data\RAMDisk\ABC.SCN	"	C _R
---------	---	---	-------------------------	---	----------------

Example: Set the prefix of Logging file name to be undefined with SYSDATA command.

<Command Format>

SYSDATA	Logging	imageLoggingHeader	"	"	C _R
---------	---------	--------------------	---	---	----------------

OK Response in Non-procedure Communications (Fxxx series method)

The OK response for [Normal (Fxxx series method)] communications is compatible with the communications method for F□□□-series Vision Sensors.

The timing of the OK response when the Sensor Controller receives a MEASURE command with the [Normal (Fxxx series method)] communications method (Refer to ► Communications Module Settings (Startup Settings) (p.271)) is the same as the timing for an F□□□-series Vision Sensor.

Non-procedure Communications

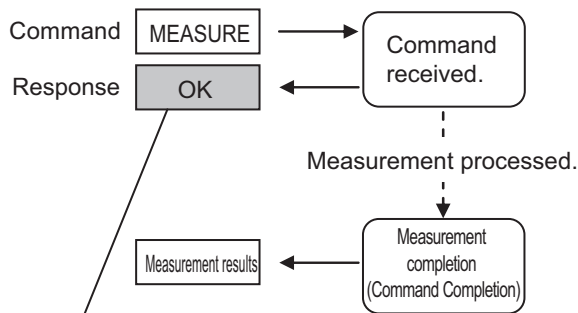

An OK response is returned when the Controller receives the command.

Non-procedure Communications (Fxxx-series Method)

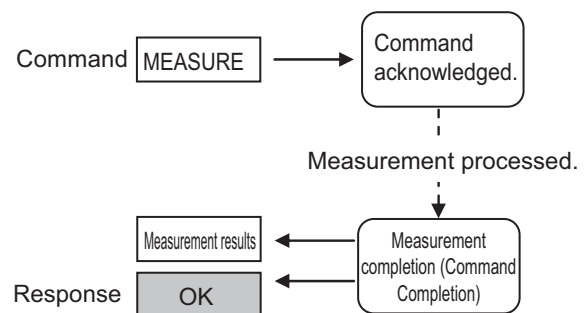

An OK response is returned when execution of the command is completed.

With serial data output (when Ethernet output is set), up to 128 processing units can be registered. However, not all data may be received depending on the network environment being used, computer performance, and the software for receiving data.

Serial Interface (RS-232C/422 Connection)

Example of Input Format (SCENE Command)

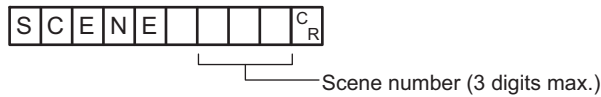

Enter a delimiter at the end of commands.

In this manual, delimiters are expressed with C_R .

Separate parameters with spaces. (Not required before delimiters.)

In the following cases, an error occurs. When an error occurs, an error end is returned as the return value.

- When non-existing commands are specified
- When the number of parameters is incorrect
- When the range of the parameters is incorrect
- When the content of parameters is incorrect
- When operation cannot be ended normally with an operation command

IMPORTANT

Commands can be input and measurement results can be output only when the Main Window is displayed on top and the BUSY signal is OFF. When using only serial commands (non-procedure), you can use the Fxxx-series method to recognize when execution of a command has been completed (i.e., when the BUSY signal turns OFF). Commands are not acknowledged while setting dialog boxes or the Edit Flow Dialog Box is displayed (excluding [Serial - Confirmation]). If data is being output after processing measurements on the Main Window, data output will be continued to the end even if you change to the Edit Flow Dialog Box or other dialog boxes. Commands are not acknowledged when windows other than the Main Window are displayed.

Command List

This section explains the input format for each command used for serial non-procedure (normal) communications. Commands are input with ASCII text. Both lowercase and uppercase letters can be used. For command details, refer to ► Non-procedure Command Details (p.426).

Execution Commands

Command	Abbreviation	Function	Reference
BRUNCHSTART	BFU	Branches to the start of the measurement flow (processing unit 0).	Reference: ► (p.429)
CLRMEAS	None	Clears all of the measurement values of the current scenes.	Reference: ► (p.429)
CPYSCENE	CSD	Copies the scene data.	Reference: ► (p.430)
DATASAVE	None	Saves System + Scene group data in the Sensor Controller's memory.	Reference: ► (p.435)
DELSCENE	DSD	Deletes the scene data.	Reference: ► (p.438)
ECHO	EEC	Returns an arbitrary string as it is to the external device, which has sent the string.	Reference: ► (p.443)
IMAGEFIT	EIF	Returns the display position and display magnification to their default values.	Reference: ► (p.450)
IMAGESCROLL	EIS	Shifts the image display position by the specified amount.	Reference: ► (p.456)
IMAGEZOOM	EIZ	Zooms the image display in or out by the specified factor.	Reference: ► (p.462)
MEASURE	M	Performs one measurement.	Reference: ► (p.474)
		Starts continuous measurement.	Reference: ► (p.474)
		Completes continuous measurement.	Reference: ► (p.475)
MEASUREUNIT	MTU	Executes a test measurement for the specified unit.	Reference: ► (p.476)
MOVSCENE	MSD	Moves the scene data.	Reference: ► (p.477)
REGIMAGE	RID	Registers the specified image data as a registered image.	Reference: ► (p.495)
		Loads the specified registered data as a measurement image.	
RESET	None	Restarts the Sensor Controller.	Reference: ► (p.496)
TIMER	TMR	Executes the specified command string after a specified delay.	Reference: ► (p.511)
UPDATEMODEL	UMD	Re-registers the model data with the current image.	Reference: ► (p.515)
USERACCOUNT	UAD	Adds a user account to a specified group ID.	Reference: ► (p.517)
		Deletes a specified user account.	

Commands to Get Status

Command	Abbreviation	Function	Reference
DIPORTCOND	DPC	Gets the ON/OFF status of all parallel DI terminals	Reference: ► (p.441)
IMAGEDISPCOND	IDC	Gets the image mode for the specified Image Display Pane.	Reference: ► (p.448)

Command	Abbreviation	Function	Reference
IMAGESUBNO	ISN	Gets the image currently displayed on the specified Image Display Pane.	Reference: ► (p.458)
IMAGEUNITNO	IUN	Gets the unit number currently displayed on the specified Image Display Pane.	Reference: ► (p.460)
INPUTTRANS-STATE	ITS	Gets the input status (enabled/disabled) for the Communications Modules.	Reference: ► (p.466)
LAYOUTNO	DLN	Gets the number of the layout that is currently displayed.	Reference: ► (p.469)
LOGINACCOUNT	LAI	Gets the user name for the currently logged in user account.	Reference: ► (p.471)
LOGINACCOUNT-GROUP	LAG	Gets the affiliation group ID for the currently logged in user account.	Reference: ► (p.473)
OPELOGCOND	OLC	Gets logging operation state.	Reference: ► (p.478)
OUTPUTTRANS-STATE	OTS	Gets the output status (enabled/disabled) to external devices.	Reference: ► (p.480)
PARAALLCOND	PAC	Gets the ON/OFF status of all parallel terminals except for DI terminals	Reference: ► (p.482)
PARAPORTCOND	PPC	Gets the ON/OFF status of the specified parallel I/O terminal.	Reference: ► (p.490)
SCENE	S	Gets the current scene No.	Reference: ► (p.497)
SCNGROUP	SG	Gets the scene group No currently in use.	Reference: ► (p.499)

Commands to Set Status

Command	Abbreviation	Function	Reference
DOPORTCOND	DPC	Sets the ON/OFF status of all parallel DO terminals	Reference: ► (p.442)
IMAGEDISPCOND	IDC	Sets the image mode for the specified Image Display Pane.	Reference: ► (p.448)
IMAGESUBNO	ISN	Sets the image to be displayed on the specified Image Display Pane.	Reference: ► (p.458)
IMAGEUNITNO	IUN	Sets the unit number to be displayed on the specified Image Display Pane.	Reference: ► (p.460)
INPUTTRANS-STATE	ITS	Enables/disables inputs to the Communications Modules.	Reference: ► (p.466)
LAYOUTNO	DLN	Sets the layout number and changes the image.	Reference: ► (p.469)
LOGINACCOUNT	LAI	Changes the user account used by the user currently logging in.	Reference: ► (p.471)
OPELOGCOND	OLC	Sets logged operation state.	Reference: ► (p.478)
OUTPUTTRANS-STATE	OTS	Enables/disables outputs to external devices.	Reference: ► (p.480)
PARAALLCOND	PAC	Sets the ON/OFF status of all parallel terminals, except for DO terminals	Reference: ► (p.482)
PARAPORTCOND	PPC	Activates/deactivates the specified parallel I/O terminal.	Reference: ► (p.490)
SCENE	S	Switches scene No. currently being used.	Reference: ► (p.497)
SCNGROUP	SG	Switches the scene group number.	Reference: ► (p.499)

Commands to Read Data

Command	Abbreviation	Function	Reference
DATALOGCOND	DLC	Gets the conditions that are set for data logging.	Reference: ► (p.431)
DATALOG-FOLDER	DLF	Gets the defined data logging folder name.	Reference: ► (p.433)
DATE	None	Gets the current date and time.	Reference: ► (p.436)
DIOFFSET	DIO	Gets the parallel DI terminal offset data that is set.	Reference: ► (p.439)
IMAGECAPTURE-FOLDER	ICF	Gets the defined screen capture folder name.	Reference: ► (p.446)
IMAGELOG-FOLDER	ILF	Gets the defined image logging folder name.	Reference: ► (p.452)
IMAGELOG-HEADER	ILH	Gets the set image logging prefix.	Reference: ► (p.454)
SYSDATA	None	Gets settings related to image logging.	Reference: ► (p.505)
UNITDATA	UD	Gets the parameters and/or measurement values of specified processing units.	Reference: ► (p.512)
VERGET	None	Gets system version information.	Reference: ► (p.519)

Commands to Write Data

Command	Abbreviation	Function	Reference
DATALOGCOND	DLC	Sets the data logging conditions.	Reference: ► (p.431)
DATALOG-FOLDER	DLF	Sets the data logging folder name.	Reference: ► (p.433)
DATE	None	Sets the date/time.	Reference: ► (p.436)
DIOFFSET	DIO	Sets the parallel DI terminal offset data.	Reference: ► (p.439)
IMAGECAPTURE-FOLDER	ICF	Sets the screen capture folder name.	Reference: ► (p.446)
IMAGELOG-FOLDER	ILF	Sets the image logging folder name.	Reference: ► (p.452)
IMAGELOG-HEADER	ILH	Sets the image logging prefix.	Reference: ► (p.454)
SYSDATA	None	Changes settings related to image logging.	Reference: ► (p.505)
UNITDATA	UD	Sets the parameters of specified processing units.	Reference: ► (p.512)

File Load Commands

Command	Abbreviation	Function	Reference
BKDLOAD	None	Loads System + Scene group 0 data.	Reference: ► (p.427)
SCNLOAD	None	Loads the scene data.	Reference: ► (p.501)
SGRLOAD	None	Loads the scene group data.	Reference: ► (p.503)
SYSLOAD	None	Loads system data.	Reference: ► (p.509)

File Save Commands

Command	Abbreviation	Function	Reference
ALLIMAGESAVE	AIS	Saves all the image data in the image buffer (specified with [main unit logging image]).	Reference: ► (p.426)
BKDSAVE	None	Saves System + Scene Group 0 data in a file.	Reference: ► (p.428)
IMAGECAPTURE	EIC	Captures the screen.	Reference: ► (p.444)
IMGSAVE	None	Saves the image data.	Reference: ► (p.464)
LASTIMAGESAVE	LIS	Save the last image input.	Reference: ► (p.468)
SCNSAVE	None	Saves the scene data.	Reference: ► (p.502)
SGRSAVE	None	Saves the scene group data.	Reference: ► (p.504)
SYSSAVE	None	Saves system data.	Reference: ► (p.510)

Output Format

If the processing unit [Data Output] is set in a scene, measurement results are sequentially output starting from the smallest data No. set in [Setting] of [Data Output]. You can also place more than one Data Output Unit in the measurement flow. You can then use record separators to identify the data for individual Data Output Units.
Reference: ► Output Format (Data Output) (p.282)

Outputting ASCII Data

Set the output format as [ASCII] in [Output form] of the [Data Output] processing item.
The default setting is [ASCII].

Output Format

Data 0 measurement value	,	Data 1 measurement value	,	...	Data 7 measurement value	C _R
--------------------------	---	--------------------------	---	-----	--------------------------	----------------

Note

The output format, number of digits, data separator, etc., can be changed if necessary.
Refer to ► Output Data Settings (Processing Item Registration) (p.279)

Example: Integer digits: "5 digits", decimal places: "3 digits", negative numbers: "-", field separator: "comma", record separator: "delimiter"

1	2	3	4	5	.	6	7	8	,	5	6	7	.	3	2	1	,	-	7	6	.	9	2	1	,	...	6	5	9	8	7	.	1	6	5	C _R
Data 0 measurement value										Data 1 measurement value							Data 2 measurement value							Data 7 measurement value												
										Field separator																	Record separator									

Note

- Field separators are not output if there is no following data.
- Lower decimal digits are rounded up before the data is output.

The range of values that can be output is as follows:

$-999999999.9999 \leq \text{Measurement value} \leq 999999999.9999$

When measurement value < -999999999.9999 , "-999999999.9999" is output.

When measurement value > 999999999.9999 , "999999999.9999" is output.

When JG (Judgement) is set, the next values are output.

OK: 1

NG: -1

Note

After the measurement is completed, data output will not stop until all of the data is output. Data output will not be interrupted.

Outputting Binary Data

Set the output format as [Binary] in [Output form] of the [Data Output] processing item.

Output Format



The measurement data is multiplied by 1000 and output is continuous with 4 bytes per data item. Negative numbers are output in 2's complement format.

2's Complement

Refer to ► *Definitions of Basic Terms in the Vision System FH/FZ5 Series User's Manual (Cat. No. Z365)*.

Example: When Data 0 is "256.324", and data 1 is "-1.000"

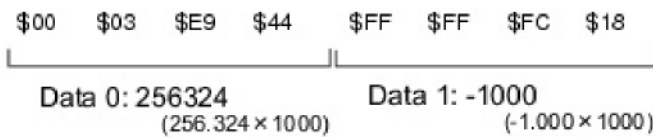

Note

Unlike ASCII output, binary output has no separators between data, such as field separators or record separators. Refer to ► Output Format (Data Output) (p.282)

The range of values that can be output is as follows:

$-2147483.648 \leq \text{Measurement value} \leq 2147483.647$

When measurement value < -2147483.648 , "-2147483.648" is output.

When measurement value > 2147483.647 , "2147483.647" is output.

When JG (Judgement) is set, the next values are output.

OK: 1000 (1×1000)

NG: -1000 (-1×1000)

Note

After the measurement is completed, data output will not stop until all of the data is output. Data output will not be interrupted.

Non-procedure Communications Troubleshooting

Cannot Input to the Sensor Controller

Problem	Cause	Action
No response is received after sending serial commands.	There is a problem with the wiring.	Check the wiring. Check the cable connections.
	There is a problem with the communication specification settings.	Make sure that the settings are correct.
Responses are no longer received after sending serial commands (but communications were working previously).	You are attempting to send commands while the BUSY signal is still ON.	Send commands only when the BUSY signal is OFF.
	A cable has been disconnected.	Check the cable connections.
	A connector has been disconnected.	Check the connector connections.
	The Vision Sensor is in Edit Mode.	Change to RUN or ADJUST Mode.

No Data Is Output from the Sensor Controller

Problem	Cause	Action
There is absolutely no data output.	The output IP address is incorrect.(Ethernet communications only)	Set the output IP address correctly.
	There is a problem with the wiring or a cable has been disconnected.	Check the wiring. Check the cable connections.
	A connector has been disconnected.	Check the connector connections.
	You have not added any Data Output processing items in the measurement flow.	You have not added any Data Output processing items in the measurement flow.
	The [Output] option is not selected.	Select the [Output] option.
	The target output device for the Data Output Unit is incorrect.	Make sure that the setting is correct.
Data is sometimes output, but sometimes not.	A cable has been disconnected or there is a connection problem.(RS-232C/422 communications only)	Check the cable connections.
	The measurement commands are not being received.(Ethernet communications only)	Check to confirm that an OK response is being returned after sending a measurement command.
Output is unstable.	There is no terminating resistance.(Ethernet communications only)	Output stability may be improved by adding terminating resistance when using RS-422 communications.

Slow Operation

Problem	Cause	Action
Response and data output is slow.	The baud rate is too low for the amount of data being transferred.	Increase the baud rate for communications or use a different communications method.

Parallel Communications

This section describes the required communication settings, communication specifications, input/output format, and communication timing chart for parallel communication between the Sensor Controller and external devices.

Communications Processing Flow

The Sensor Controller communicates with external devices via a parallel interface.

I/O Signals and Data for Communicating with External Devices

This section describes the basic connections and signal flow with external devices.

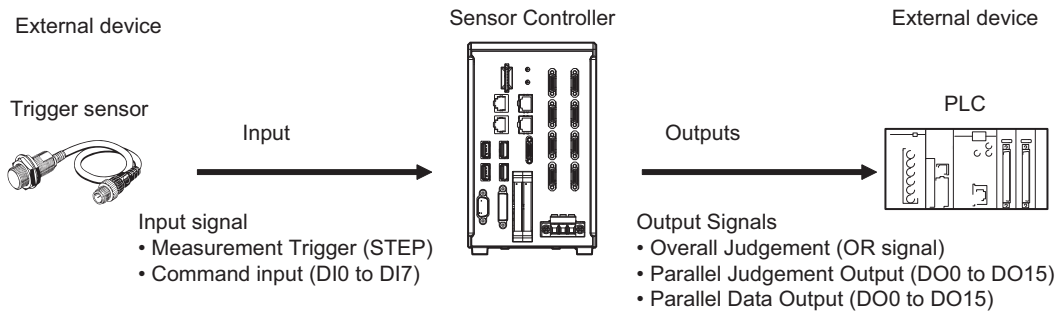

Inputs

You can input the following signals to the Sensor while the Main Window is displayed.

- **Measurement Trigger (STEP signal)**
Measurement is performed once when STEP signal turns ON. (Single Measurement)
- **Command Input (DI0 to DI7 Signals)**
You can send commands and control the Sensor by turning the DI0 to DI7 signals ON and OFF. Refer to the following section for details on Sensor control commands.
Reference: ► Command Formats (p.332)

IMPORTANT

Note that if DI7 is ON after the command is executed, the command will be executed repeatedly.
Reference: ► DI0 to DI7 (Command Execution) Timing (p.328)

Outputs

Each time measurement is performed, the measurement results are output.

The following measurement results can be output:

- **Overall Judgement (OR signal)**
The results of more than one processing item are judged.
The overall judgement will be NG if even one of the individual judgement results is NG.*1
*1: With the default settings, output is performed even if the overall judgement result is NG, but this can be changed so that output is performed only when the overall judgement result is OK. Reference: ► Setting the Output Signal Specifications (p.305)
- **Parallel Data Output (DO0 to DO15 Signals)**
The measured values of processing items or the calculation results of expressions are output.
- **Parallel Judgement Output (DO0 to DO15 Signals)**
The measured values of the processing items or calculation results are judged and the judgement results are output.

Note

If the operation mode is set to Multi-line Random-trigger Mode and the number of lines to use simultaneously was increased, the signals, control, and output that can be performed is different from when only a single line is used, as described in the following table.

For the signals that can be used and for differences in assignments, refer to ► Multi-line Random Trigger Mode Signal Specifications (p.325).

FH-1000/FH-3000 series Sensor Controller

Number of controlled lines	Differences from when only a single line is used (i.e., when the operation mode is not set to Multi-line Trigger Mode)
2 lines	<ul style="list-style-type: none"> The usable functions are the same as for when only a single line is used. DO signals are divided as follows: Line 0: DO0 to DO7, Line 1: DO8 to DO15
3 or 4 lines	<ul style="list-style-type: none"> Parallel data output and parallel judgement output cannot be performed (DO signals cannot be used). Handshaking output cannot be used (the GATE signal and DSA signal cannot be used). An encoder cannot be used.
5 to 8 lines	<ul style="list-style-type: none"> The RUN signal cannot be used. The same ERR signal is used for all lines. Parallel data output and parallel judgement output cannot be performed (DO signals cannot be used). Handshaking output cannot be used (the GATE signal and DSA signal cannot be used). An encoder cannot be used.

FZ5-800/FZ5-1100/FZ5-1200 series Sensor Controller

Number of controlled lines	Differences from when only a single line is used (i.e., when the operation mode is not set to Multi-line Random-trigger Mode)
2 lines	<ul style="list-style-type: none"> The RUN signal cannot be used. The same ERR signal is used for all lines. DO signals are divided as follows: Line 0: DO0 to DO7, Line 1: DO8 to DO15
3 to 8 lines	The FZ5 does not support using 3 to 8 lines (operation will not be dependable).

Communications Setup Procedures

The following settings are required to use parallel communications.

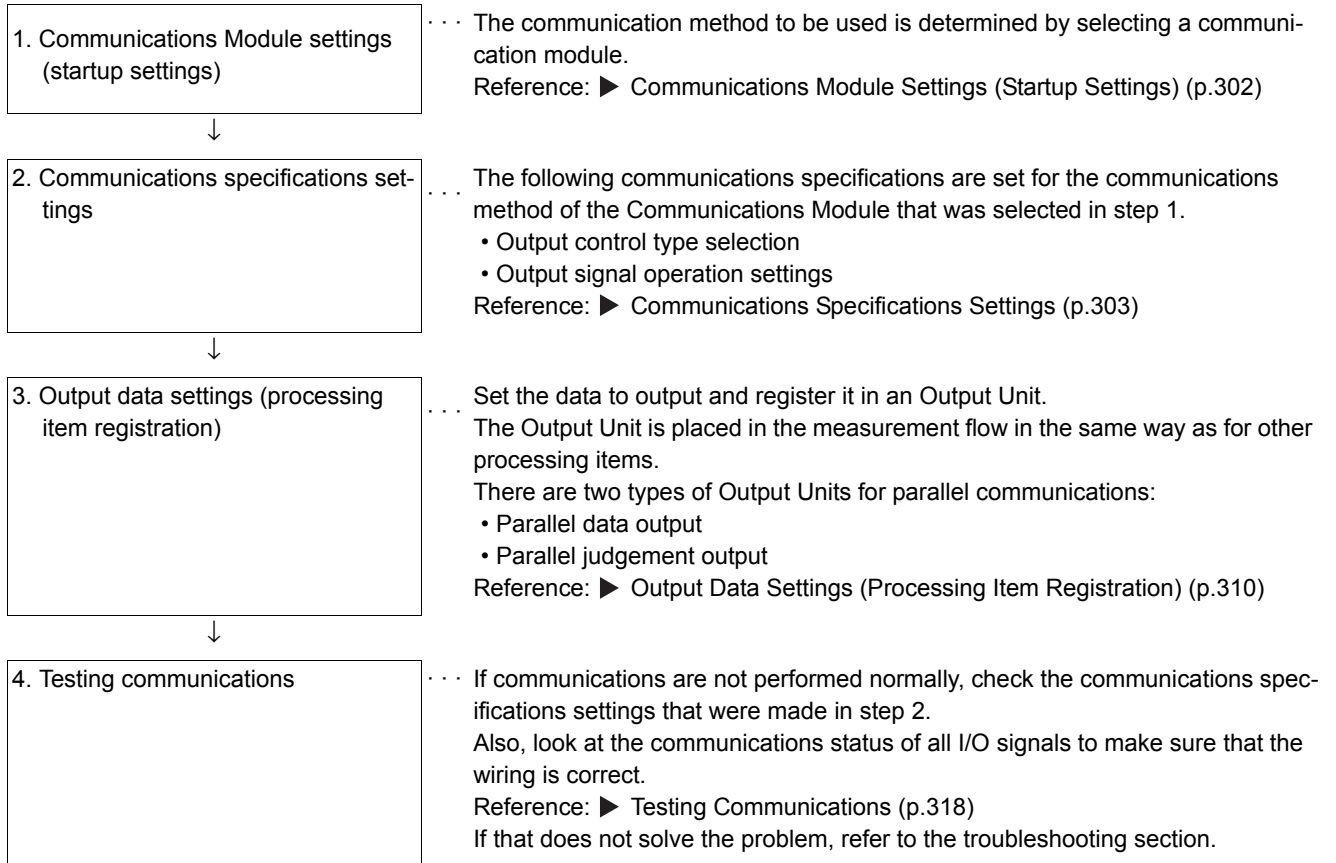

Communications Module Settings (Startup Settings)

The communication method used for communication with the Sensor Controller is selected from the communication modules.

- 1 On the Main Window, select [Tool] – [System Settings].
- 2 Select [System setting] – [Startups] – [Startup setting] on the Multiview Explorer on the left and then click [Communication].

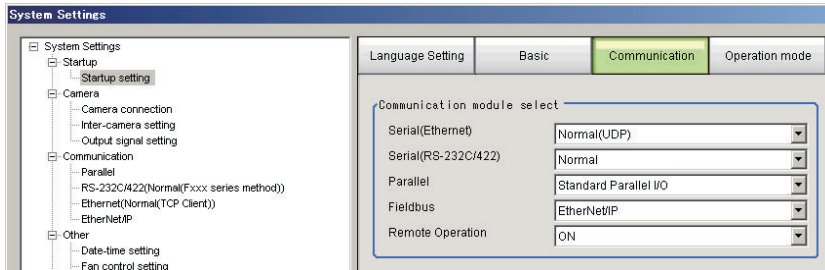

- 3 Select one of the following Communications Modules based on the communications method that is used to connect with the Sensor Controller and the Unit to connect to, then click [Apply].

Communications Module	Description
Parallel	Select this Communications Module to perform parallel interface communications.
Standard Parallel I/O	

- 4 Click the [Data save] button in the Toolbar.

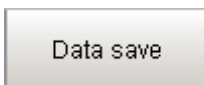

- 5 On the Main Window, select [Function] – [System restart].
Click [OK] in the [System restart] dialog box to restart the Sensor Controller.
- 6 When the Sensor Controller has restart, operation will be performed for the default settings of the specified Communications Module.

Note

You can save the Communications Module settings to a file.
Select [Save to file] from the [Function] menu, and then select [System data] or [System + Scene group 0 data] to save the settings data to a file.
Refer to ► *Saving the Conditions That Are Related to Operation during Measurement* in the *Vision System FH/FZ5 Series User's Manual* (Cat. No. Z365).

Communications Specifications Settings

Set the communications specifications, such as the data output method and data signal operation. If communications cannot be performed even after setting these communications settings, check the settings and the communications status. Reference: ► Testing Communications (p.318)

IMPORTANT

- Before you set the communications specifications, select the Communications Module to use with the Sensor Controller in the startup settings. Reference: ► Communications Module Settings (Startup Settings) (p.62)
- After you select the Communications Module, save the settings to the Sensor Controller and restart the Sensor Controller. If you do not restart the Sensor Controller, the selected Communications Module will not be enabled.

Note

Input signals cannot be handled during setting of communications specifications. However, the input status can be checked with [Confirmation].

Reference: ► Testing Communications (p.318)

Selecting the Output Control Type

You can select the data output timing control method to use so that you can synchronize the timing of output with the external device.

Types of Output Control

• None

After measurements are completed, the Sensor outputs the measurement results without synchronizing with the external device.

Or, output is performed based on the GATE signal. Adjust the external device so that it reads the measurement results when the GATE signal is output.

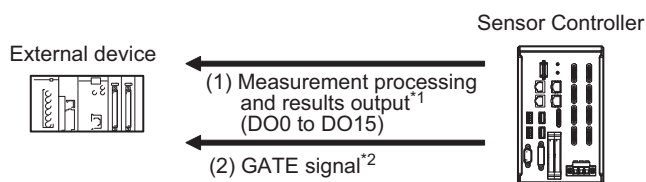

*1: Overall judgement (OR) output is output when measurement is completed, regardless of when the Output Unit was executed.

*2: You can change the settings of when the GATE signal is turned ON after the measurement data is output and the length of time that the GATE signal will remain ON. Reference: ► Communications Specifications Settings (p.303)

Note

The GATE signal will not be output if there is no data set for parallel judgement output and parallel data output. If only the OR signal is output, read the OR signal when the BUSY signal turns OFF.

• Handshaking

Measurement results are output only after it is determined that the external device can receive data.

Handshaking is effective for sequentially outputting many measurement results and it is a reliable way to transfer data.

Reference: ► Data Output Control with Handshaking (p.32)

• Synchronization Output

The measurement results are output after the STEP signal has turned ON for the number of delays set in [Number of delay]. The output timing of the measurement results from the Sensor can be offset according to the actual timing of processing on the line.

Example: Sequential Feed Line that Uses a Star Wheel

The discharge timing for when a defective part is found and the measurement results output timing can be synchronized.

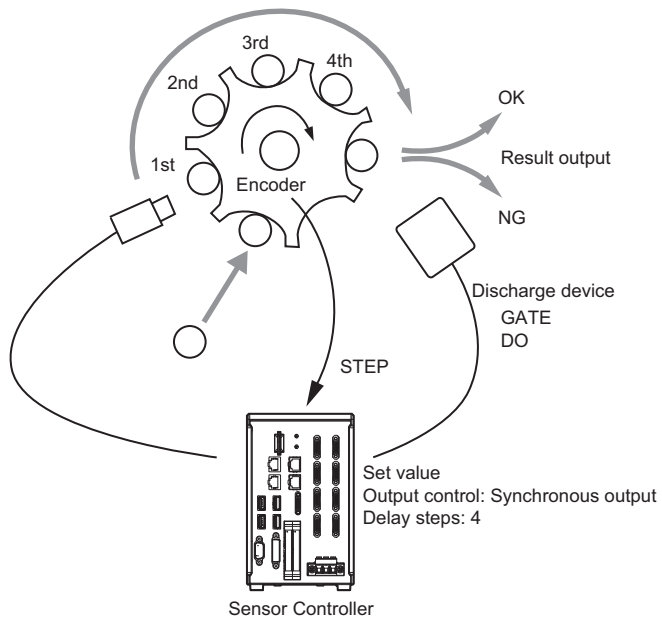

Note

- When synchronized output is enabled in the communications specifications, the steps will be counted according to the number of times the STEP signal turns ON. Set the settings so that results are output only once for each measurement. (Place only one Output Unit in the measurement flow (either Parallel Judgement Output or Parallel Data Output). For Parallel Data Output, set only one output item.)
- Designate only the STEP signal for measurement trigger input.
If measurements are performed using serial commands and continuous measurement, the output time will not match and this can cause Sensor malfunctions.

Setting the Output Signal Specifications

You can change the operation of signals output with parallel communications.

Changing the Judgement Output ON Conditions (Output Polarity)

The ON conditions for the OR signal and the DO0 to DO15 signals can be set to turn ON the signals when the judgement results are OK or when they are NG. The default setting is [ON at NG].

This setting can be changed by setting the [Output polarity] in the communications specifications. Reference: Reference: ► Communications Specifications Settings (p.308)

Setting the Timing to Turn OFF the Overall Judgment (OR) signal. (One-shot Output)

You can select from the following two methods for the timing of when the Overall Judgment (OR) signal turns OFF after measurement result confirmation.

This setting can be changed by setting [One-shot OR signal] in the communications specifications.

Reference: ► Communications Specifications Settings (p.308)

- **One-shot Output Disabled (Default)**

The OR signal stays ON until the judgement changes.

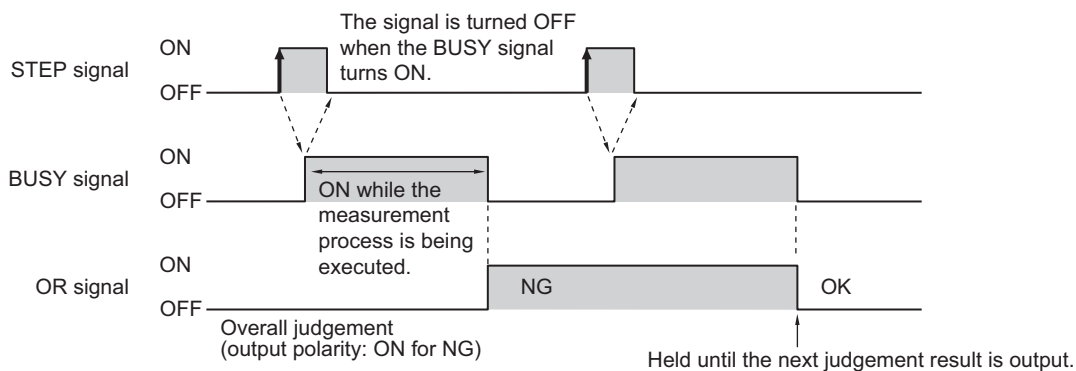

- **One-shot Output**

OR signal output stays ON for a certain amount of time, and then it is turned OFF again.

The time to maintain the OR signal output can be specified. (Setting range: 0.1 to 1000.0 ms)

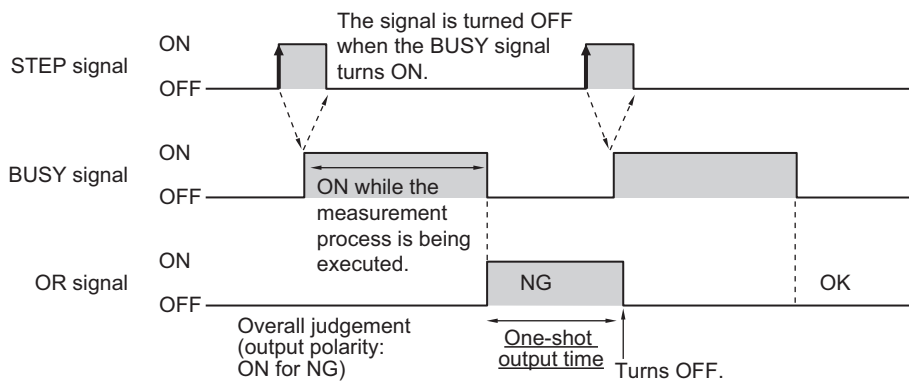

Outputting the STGOUT and SHTOUT Signals

These functions are supported by the FH-series Sensor Controllers only.

With parallel communications, the STGOUT signal (strobe trigger output) and SHTOUT signal (shutter output) cannot be output at the same time.

Select which signal to output based on your needs.

- 1 On the Main Window, select [System Settings] – [Camera] – [Output Signal Setting] from the [Tool] menu.**

The output signal settings dialog box is displayed.

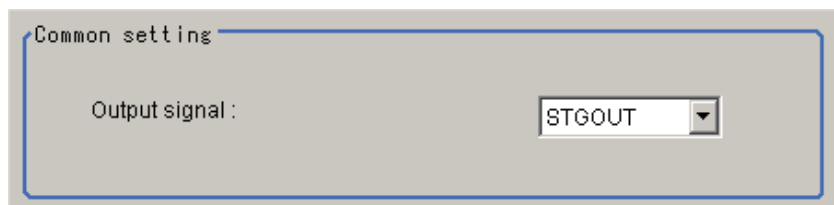

- 2 Select the signal to output in the [Common] area.**

Setting item	Setting value [Factory default]	Description
Output signal	[STGOUT]	Uses the STGOUT signal line as the STGOUT signal. When STGOUT is selected, the SHTOUT signal cannot be used.
	SHTOUT	Uses the STGOUT signal line as the SHTOUT signal. When SHTOUT is selected, the STGOUT signal cannot be used.

Note

- In Multi-line Random-trigger Mode, this output signal selection can be used to set the output signal for line 0 only. The setting for line 0 will be used for all other lines.
- The STGOUT signal output settings must be set in the [Electronic flash setting] for each Camera Image Input processing item.

IMPORTANT

SHTOUT signals output through EtherCAT communications are not affected by this setting.

SHTOUT Signal Settings: [Output Signal Setting]

These functions are supported by the FH-series Sensor Controllers only.

This setting sets the SHTOUT signal that is output when the Camera exposure is completed. By detecting when the exposure is completed using the SHTOUT signal, you can minimize the amount of time that the workpiece must be kept still for imaging and you can move the Camera or workpiece immediately after the exposure is completed.

1 On the Main Window, select [System Settings] – [Camera] – [Output Signal Setting] from the [Tool] menu.

The output signal settings dialog box is displayed.

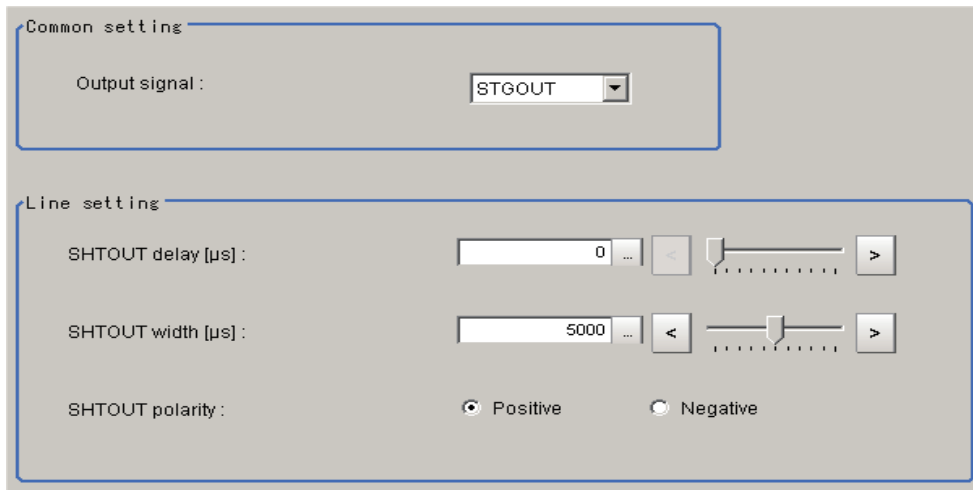

2 Set the SHTOUT signal for each line in the [Line settings] area.

Setting item	Setting value [Factory default]	Description
SHTOUT delay [μs]	0 to 1000 [0]	Set the delay time until the SHTOUT signal turns ON after exposure is completed in 10 μs increments.
SHTOUT width [μs]	40 to 10000 [5000]	Set the SHTOUT signal output time in 10 μs increments.
SHTOUT polarity	<ul style="list-style-type: none"> • [Positive] • Negative 	Set the pulse polarity of the SHTOUT signal. Positive: The SHTOUT signal turns ON when exposure is completed. Negative: The SHTOUT signal turns OFF when exposure is completed.

3 Click [Apply].

IMPORTANT

- If more than one Camera is connected, the SHTOUT signal will remain ON for the Camera with the longest exposure time.
- You cannot use the Shutter Output Signal when the image mode is set for a through image.
- If you have registered more than one Camera Image Input processing unit in the measurement flow, the SHTOUT signal will be turned ON for each Camera Image Input processing unit individually.
- The SHTOUT signal will be output for as many times as imaging is performed when Camera Image Input HDR or Camera Image Input HDR Lite processing item is used.
- The SHTOUT signal that is output through EtherCAT communications is affected by this setting.

Communications Specifications Settings

Use the following procedure to select the type of output control, set the output signal operation, and set other parallel interface communications specifications.

- 1 On the Main Window, select [Tool] – [System Settings] – [Communication].**
- 2 Select [System Settings] – [Communication] – [Parallel] from the tree view on the left.**
The Parallel View is displayed.
- 3 Click [Setting] to set the communications specifications.**

Setting	Confirmation
Output polarity :	ON at NG
Output control :	None
Output period [ms] :	10.0
Gate ON delay [ms] :	1.0
Output time [ms] :	5.0
Timeout [s] :	10.0
Number of delay :	1
<input type="checkbox"/> One-shot OR signal	
Output time [ms] :	5.0

4 Set the following items to define the communications specifications.

Setting item	Setting value [Factory default]	Operation
Output polarity	On at OK	The output is turned ON if the judgement is OK. For the overall judgement, the output is turned ON if all judgements are OK.
	[On at NG]	The output is turned ON if the judgement is NG. For the overall judgement, the output is turned ON if even one judgement is NG.
Output control	[None]	Method to output measurement results without synchronizing with external devices. Reference: ► Output Control: None (p.337)
	Handshaking	Method to output measurement results while synchronizing with external devices. Reference: ► Output Control: Handshaking (p.338)
	Synchronization output	Method to output measurement results while synchronizing with line processing timing. The STEP signal is ignored the number of times set in [Number of delay], and measurement results are output when the STEP signal next turns ON. If through images are displayed, however, synchronization output cannot be used. Reference: ► Output Control: Synchronization Control (p.339)
Output period [ms]	2.0 to 5000.0 ms [10.0 ms]	Valid only when [Output control] is set to [None]. Set the cycle by which measurement results are output. Set the cycle so that the interval is equal to or longer than [Gate ON delay + Output time] and shorter than measurement interval. If the cycle is longer than the measurement interval, output timing will be delayed while measurement is being repeated.
Gate ON delay [ms]	1.0 to 1000.0 ms [1.0 ms]	Set the time from when results are output to the parallel interface to when the GATE signal turns ON. Waiting time until data output is stable. Set this so that it is longer than the external device delay time.
Output time [ms]	1.0 to 1000.0 ms [5.0 ms]	This setting is enabled only when the [Output control] parameter is set to [None] or [Synchronized output]. Set the GATE signal ON time. Set the time required for external devices to acquire measurement results.
Timeout [s]	0.5 to 120.0 s [10.0 s]	<ul style="list-style-type: none"> • If handshaking is used for output control, a timeout error will occur if there is no response from the external device within the set timeout interval. • When the DSA signal turns ON after measurements are completed • When the DSA signal turns OFF after the GATE signal turns ON • When the DSA signal turns ON after the GATE signal turns OFF • When using signals DI0 to DI6 and DI7 to execute a command, a timeout error will occur if the time from when the ACK signal turns ON until the DI7 signal turns OFF exceeds the set timeout interval. (FH only)
Number of delay	1 to 15 [1]	This setting is enabled only when the [Output control] parameter is set to [Synchronized output]. Set the number of times that the STEP signal turning ON will be ignored before measurement results of the STEP signal are output.

Setting item	Setting value [Factory default]	Operation
One-shot OR signal	ON	After the measurement results are finalized, if the judgement output ON condition is met, the OR signal is turned ON for the one-shot output time. It is then turned OFF after the specified time has elapsed.
	[OFF]	The judgement is output after measurement results are finalized and the ON/OFF status of the OR signal is held until it is changed for the next measurement result.
	Output time	When One-shot Output Mode is selected, this parameter sets the time that the OR signal is ON. (Setting range: 0.1 to 1000.0 ms)

*1: For Parallel Judgement Output, you can change the output polarity of each Parallel Judgement Output unit regardless of the value of this setting.

IMPORTANT

Set the OR one-shot output time in the following range:

External device OR signal read period (cycle time) – 1.0 ms < OR one-shot output time < Measurement trigger interval (measurement takt time) – 0.5 ms

1 Click [Apply].

The settings are confirmed and the Parallel View closes.

Output Data Settings (Processing Item Registration)

Set the data to output with parallel communications.

The following three types of data can be output with parallel communications:

- OR signal
- Parallel judgement output
- Parallel data output

Note

- The OR signal is output automatically, even if no Output Units are set.
- To perform Parallel Judgement Output or Parallel Data Output, you must register an Output Unit in the measurement flow and set the required output details.
- If you control from three to eight lines in Multi-line Random-trigger Mode, you cannot use Parallel Judgement Output or Parallel Data Output.

Data Output by Output Data Type

OR Signal

This signal outputs the overall judgement.

You can determine the overall judgement by monitoring the status of the OR signal.

After the measurement results are established, the OR signal will be output automatically if the overall judgement is NG.

You can also set the signal to be output if the overall judgement is OK.

Reference: ► Setting the Output Signal Specifications (p.305)

Note

The overall judgement gives the results of more than one processing item. As a result, the overall judgement will be NG if even one of the individual judgement results is NG.

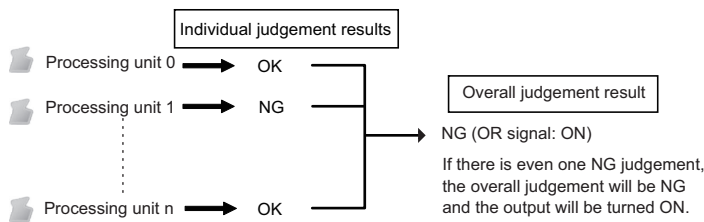
**Parallel Data Output**

The measured values of processing items or the calculation results of expressions are output. Data items can be set from data 0 to data 7. Each item is output using the 16 bits from DO0 to DO15.

The data output specifications are as follows:

- Only integers are output. Decimals are rounded off.
- The range of values that can be output is as follows:

Binary format: -32768 to $+32767$

BCD format: -999 to $+999$

If the measurement value is out of range, the actual measurement value is not output and the minimum or maximum value of the range is output instead.

Data type	Measurement value that is below the possible output range	Measurement value that is above the possible output range
Binary	A value of -32768 is output.	A value of $+32767$ is output.
BCD	A value of -999 is output.	A value of $+999$ is output.

Note

When the operation mode is set to Multi-line Random-trigger Mode, the parallel data output range is between -127 and 127 for binary data, and -9 and 9 for BCD data.

Parallel Judgement Output

The measured values of the processing items or calculation results are judged and the judgement results are output.

Judgement results can be set from judgement 0 to judgement 15. Each result is output with 16 bits from DO0 to DO15.

Setting Up Parallel Data Output

The measured values of processing items or the calculation results of expressions are output.

Registering Parallel Output Units

Register the processing items for parallel data output in the measurement flow.

- 1 Click [Edit flow] in Toolbar.
- 2 Select the [Parallel Data Output] processing item from the processing item tree.

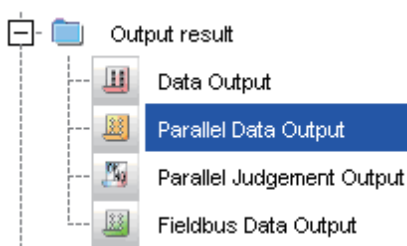

3 Click [Append].

The [Parallel Data Output] processing item is appended at the bottom of the unit list (flow).

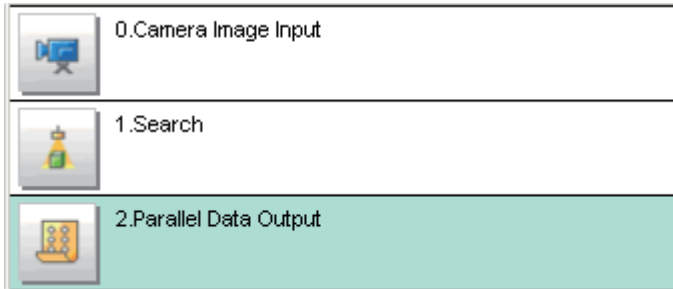

Note

Data is output in the order that data output is registered in the measurement flow, i.e., the timing is different for each data output processing unit. (Data output is executed in the order that it is executed in the measurement flow.)

Set the items to output.

In an expression, set the data to output (i.e., the measured value of a processing item or the calculation results of an expression).

Up to 8 expressions from 0 to 7 can be set in each unit.

- 1** Click the **Parallel Data Output** icon ().
- 2** In the **Item Tab Area**, click **[Setting]**.
- 3** In the list, select the output data number for the expression to set.

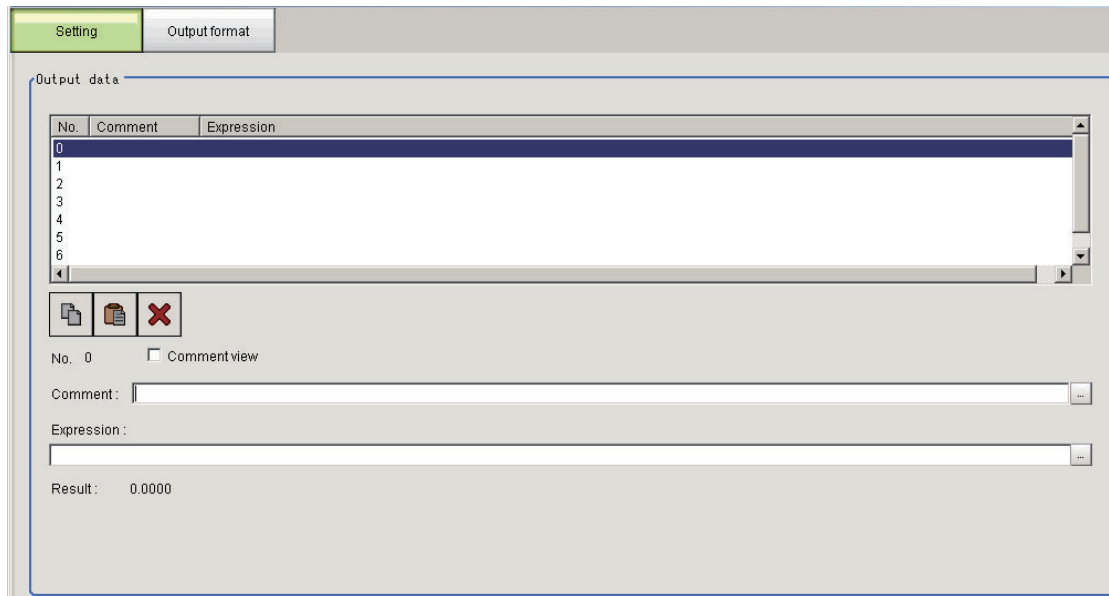

The selected output data number is displayed under the list.

- 4** Click the **[...]** button next to the expression box and set the expression.



Specify the processing items, measurement results, and measurement data in the expression.

You can also perform arithmetic or function calculations on the measurement data before it is output.

For calculation settings, refer to section of Calculation in *FH/FZ5 Processing Item Function Reference Manual* (Cat. No. Z341).

- 5** Click the **[...]** button for the **[Comment]** box and enter an explanation of the expression.

The comment you enter will be displayed in the detailed results on the Main Window.

For example, if you enter “Test” as the comment for expression 0, “Test” will be displayed in place of “Expression 0” in the detailed results area on the Main Window.

- 6** Repeat steps 4 and 5 to set expressions for all of the required output data numbers.

Note

Output When Multiple Items Are Set

The items that are set for output data numbers 0 through 7 are output to the PLC reception buffer in ascending order, one data item at a time (16-bit units). Each time a data item is output, the GATE signal turns ON.*1

When this occurs, the first data item that was output to the PLC reception buffer (data 0) is overwritten by the next output data item (data 1).

Therefore, the data output to the PLC reception buffer must be saved to PLC memory each time the GATE signal turns ON for each data item.

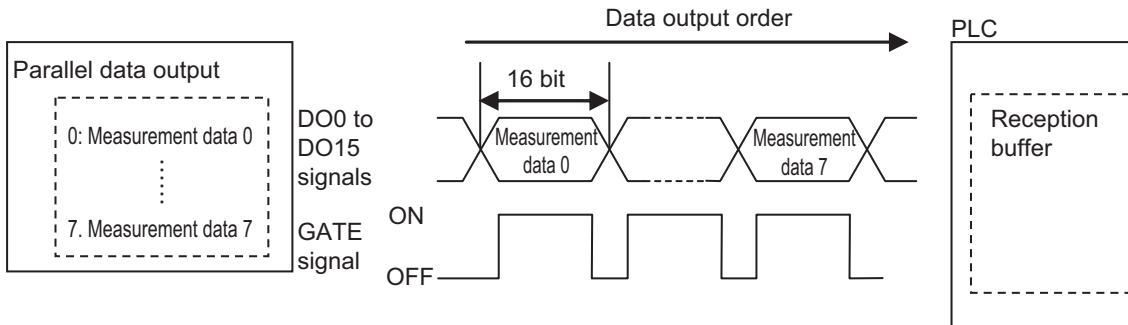

*1: The operation of the DSA signal depends on whether handshaking for output control is enabled.
Reference: ► Data Output Control with Handshaking (p.32)

Output Format (Parallel Data Output)

- 1** Click the [Parallel Data Output] icon () in the measurement unit list (flow).
- 2** In the Item Tab Area, click [Output format].
- 3** Select the output format in the output settings.

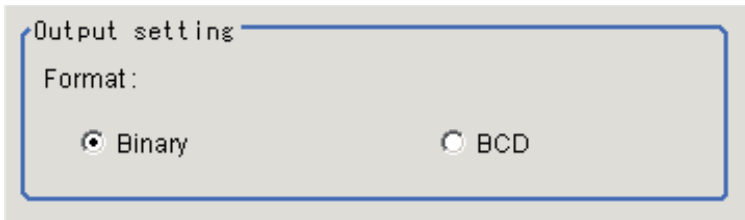

Setting value [Factory default]	Description
[Binary]	Data is output as 2's complement binary data. Information on 2's Complement Refer to ► <i>Definitions of Basic Terms</i> in the <i>Vision System FH/FZ5 Series User's Manual</i> (Cat. No. Z365).
BCD	Data is output expressing 1 digit with 4 bits and expressing a 3-digit integer and sign with 16 bits. <ul style="list-style-type: none"> • Bits 12 to 15 These bits give the sign. (positive: 0000, negative: 1111) • Bits 0 to 11 Every 4 bits express 1 digit from ones place (bits 0 to 3: 1st digit) to the hundreds place (bits 8 to 11: 3rd digit).

Registering Parallel Judgement Output Items

Use the following procedure to output the judgement results that are set for parallel output.

Registering Parallel Judgement Output Units

Register the processing items for parallel judgement output in the measurement flow.

- 1 Click [Edit flow] in the toolbar or on the Main Window.
- 2 Select the [Parallel Judgement Output] processing item from the processing item tree.

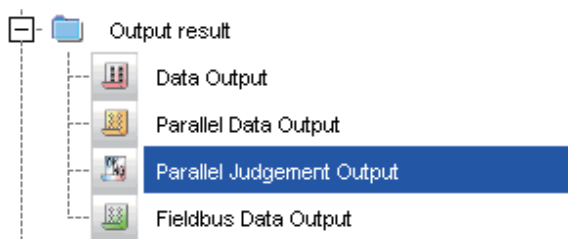

- 3 Click [Append].

The [Parallel Judgement Output] processing item is appended at the bottom of the unit list (flow).

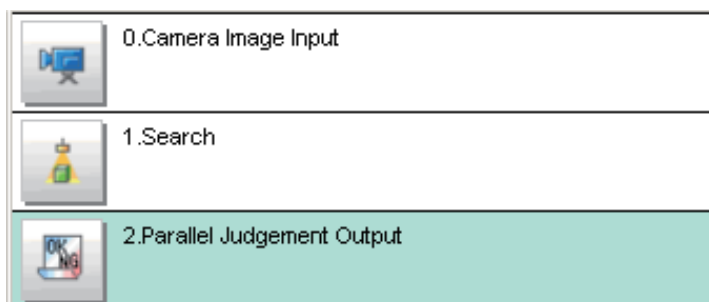

Note

Data is output in the order that data output is registered in the measurement flow, i.e., the timing is different for each data output processing unit. (Data output is executed in the order that it is executed in the measurement flow.)

Registering the Items To Output

In an expression, set the target for judgement (i.e., the measured value of a processing item or the calculation result of an expression).

Up to 16 expressions from 0 to 15 can be set in each unit.

- 1** Click the [Parallel Judgement Output] icon () in the measurement unit list (flow).
- 2** In the Item Tab Area, click [Setting].
- 3** Set the items in the output settings area.

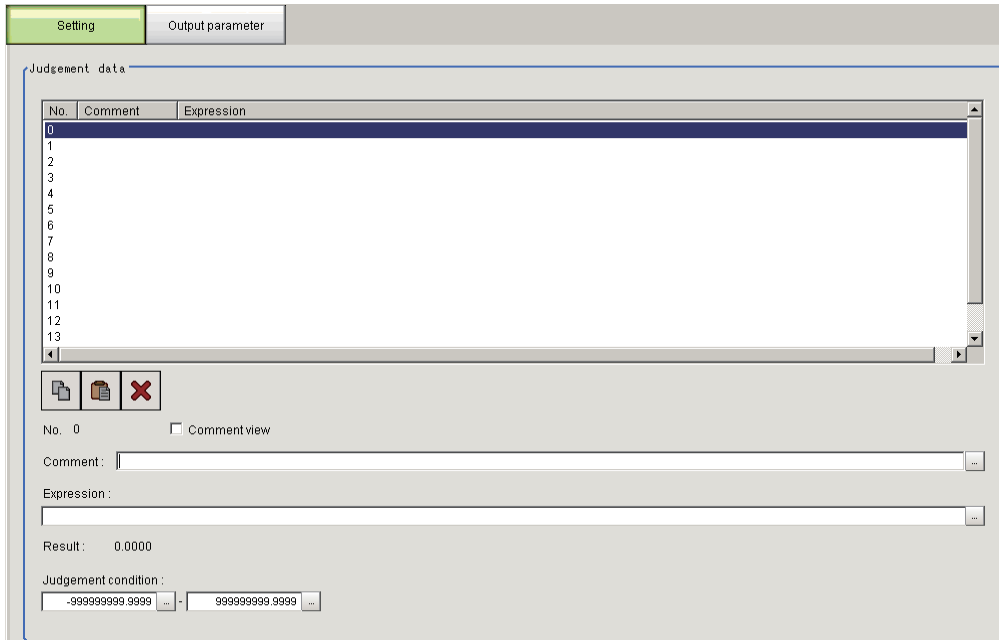

The selected output data number is displayed under the list.

- 4** Click the [...] button next to the expression box and set the expression.



Specify the processing items, measurement results, and measurement data in the expression. You can also perform arithmetic or function calculations on the measurement data before it is output. For calculation settings, refer to section of Calculation in *FH/FZ5 Processing Item Function Reference Manual* (Cat. No. Z341).

- 5** Click the [...] button for the judgement condition, and then set the upper and lower limits to judge as OK.

If the result data set in step 4 above is within the range set here, the result will be judged as OK.



- 6** Click the [...] button for the [Comment] box and enter an explanation of the expression.
- 7** Repeat steps 4 and 5 to set expressions for all of the required output data numbers.

Output Parameters (Parallel Judgement Output)

- 1 Click the [Parallel Judgement Output] icon () in the measurement unit list (flow).
- 2 Click [Output parameter] in the Item Tab Area.
- 3 Set the items in the output settings area.

Setting item	Setting value [Factory default]	Description
Output polarity		Set the output polarity of the judgment result. You can select either "System (parallel)" or "Unit."
[System (parallel)]	---	Select the setting to match the judgement result output polarity setting in the System setting menu.
Unit	<ul style="list-style-type: none"> • ON at NG • ON at OK 	Select this when you wish to set the Judgement result Output polarity for a specific processing unit. Set the Output polarity for the current unit. ON at NG: Outputs the Judgement result when it is NG. ON at OK: Outputs the Judgement result when it is OK.

- 4 For [Reflect to overall judgement], select whether to apply this processing unit's evaluation result to the overall evaluation of the scene.

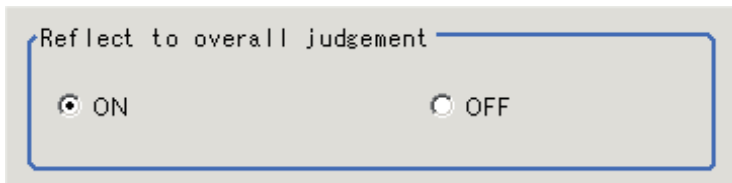

Setting value [Factory default]	Description
<ul style="list-style-type: none"> • [ON] • OFF 	Enables choosing whether the judgment results of this processing unit is reflected in the scene overall judgment.

Testing Communications

Use the following procedure to check the communications status with the external devices connected with a parallel interface. You can check whether wiring and communications settings have been performed correctly.

- 1** On the Main Window, select [Tool] – [System Settings] – [Communication].
- 2** Select [System Settings] – [Communication] – [Parallel] from the tree view on the left.
The Parallel View is displayed.
- 3** Click [Confirmation] to check the I/O status.

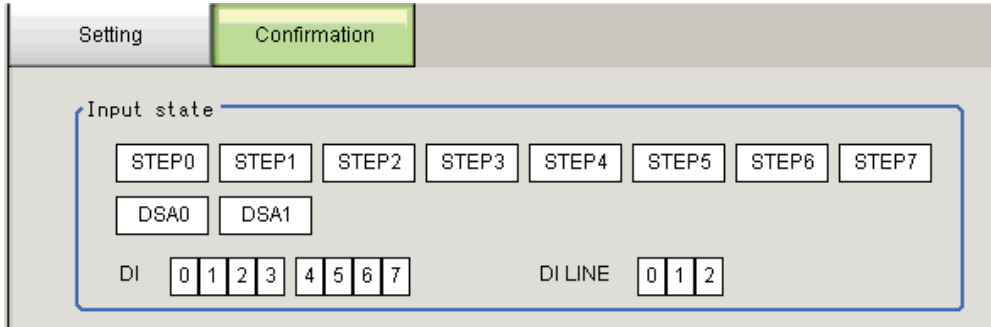

	View	Description
Input state	STEP0 to STEP7 Only the settings for STEP0 and STEP1 are valid for an FZ5-800/FZ5-1100/FZ5-1200 series Sensor Controller.	The input status of each signal from the external device to the Controller is displayed. When a signal is input, the background color changes to red.
	DSA0, DSA1	
	DI0 to DI7	
	DI LINE0 to DI LINE2 Valid only for an FH-1000/FH-3000 series Sensor Controller.	
Output state	RUN	The output status of each signal is displayed. When a signal is output, the background color changes to red. The output status from each signal of the Controller to external devices can be specified. Changes between ON and OFF and between 0 and 1 can be simulated without performing measurement.
	ERR	
	BUSY	
	OR	
	GATE	
	READY	
	ACK	
	DO0 to DO15	

4 Change the contents to be sent.

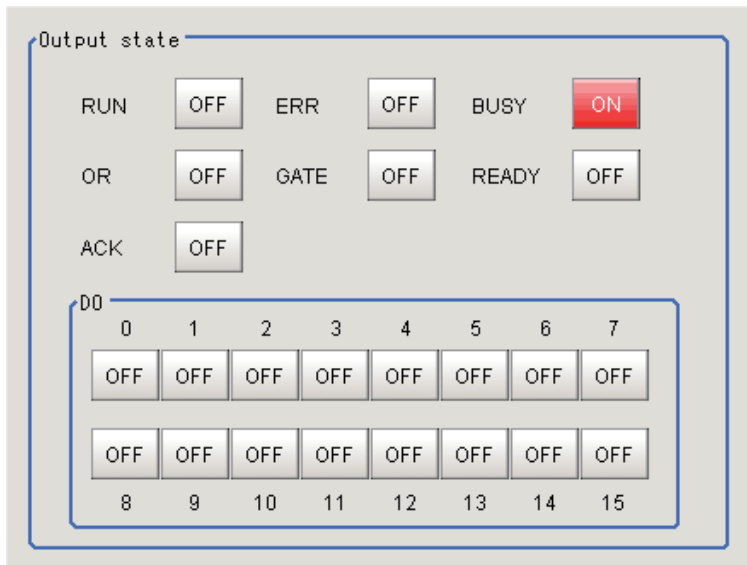

When switching between ON and OFF is performed, the changed contents are displayed on the monitors of external devices. Make sure there are no problems.

Note

For the FZ5-800/FZ5-1100/FZ5-1200 series, DO0 to DO7 of line 1 are assigned to the DO8 to DO15 parallel terminals. Therefore, if you turn ON DO0 to DO7 to test line 1 communications, signals will be output on the DO8 to DO15 parallel terminals.

IMPORTANT

The status of the following signals for the FZ5 can be checked only on the [Communication confirmation] dialog box for line 0.

- RUN, ERR, and BUSY

5 Click [Close].

I/O Signals

The following tables list the signals that are used to control I/O for parallel communications.

Input Signals

Signal	Signal name	Function	ON/OFF timing	
			OFF to ON	ON to OFF
STEP	Measurement Trigger Input	Input measurement triggers from external devices, such as optic switches. Measurement is performed after synchronizing with the STEP signal turning ON (OFF to ON). A STEP signal filter (filter initial set value: 100 μ s) is set in STEP input.	Turn ON the signal to make a measurement.	Turn OFF the signal from the PLC when the FH/FZ5 turns ON the BUSY signal.
DSA (Used only for handshaking output control.)	Data Output Request signal	This signal is to request to externally output that measurement data from the flow which was executed by the PLC at handshake time. If this signal is ON when an Output Unit (Parallel Data Output Unit) in the measurement flow is executed, the Vision Sensor will output the data from the processing item.	Turn ON the signal (from the PLC) when you wish to output the data externally. Turn the DSA signal ON when the STEP signal is turned ON. If more than one output item is set in a single Output Unit, or if more than one Output Unit has been set in the measurement flow, turn the DSA signal ON again when the GATE signal turns OFF for the first data output. Reference: ► Time Charts (p.336)	Turn OFF the signal (from the PLC) when the FH/FZ5 turns ON the Result Completion (GATE) signal.
DI0 to DI7	Command Input signals	Inputs commands from the external device.	---	---
DILINE0 to DILINE2 (FH-1000 series/FH-3000 series Sensor Controller only)	Command Input Line Specification signals	Specify the line number when inputting a command from an external device. You can use these signals in Multi-line Random Trigger Mode.	---	---
ENC (Phase A, Phase B, or Phase Z)	Encoder Input (Phase A, Phase B, or Phase Z)	This is the encoder input signal. This signal is used only when [Use Encoder trigger] is set in the system settings.	---	---

Output Signals

Signal	Signal name	Function	ON/OFF timing	
			OFF to ON	ON to OFF
RUN	Measurement Mode Signal	This signal tells whether or not the Controller is in RUN mode.	This mode will be [ON] when FH Sensor Controller is in Run Mode; Sensor Controller is in the measurable status and [RUN signal output] in Layout setup is checked.	The signal turns OFF in either of the following cases: <ul style="list-style-type: none"> • When in ADJUST Mode • When the Controller cannot perform measurements • [RUN signal output] is unchecked in the current Layout setup.
BUSY	Busy signal	This signal tells when commands and other external inputs cannot be acknowledged. Make sure this signal is OFF before you request a command. While this signal is ON, no commands will be accepted even if they are sent. Note: <ul style="list-style-type: none"> • The execution of commands or other processing received through any other protocol can be detected. • Just because this signal is ON does not necessarily mean that a command is being executed. 	The FH/FZ5 turns ON the signal when it receives a command from the user (PLC). (The signal turns ON after the EXE signal turns ON.)	The signal turns OFF when the user (PLC) turns OFF the Command Request (EXE) signal.
OR	Overall Judgement signal	Outputs the overall judgement. This is determined when the measurement is completed (BUSY signal ON to OFF). *1: The [Output polarity] setting determines whether this signal turns ON when the judgement result is OK or NG. Reference: ► Setting the Output Signal Specifications (p.305) *2: The OR signal is output only when the [Output] option is selected in the Adjustment Window.	The signal turns ON based on the judgement results when measurement is completed (i.e., when the BUSY signal turns OFF).	The status of the OR signal is maintained until the next OR signal is output. You can set the one-shot output settings so that the OR signal turns OFF automatically after a set time. You can also turn OFF the OR signal by executing the Clear Parallel OR+DO command.
DO0 to DO15	Data Output signals	These signals output the results for expressions set for a [Parallel Judgement Output] or [Parallel Data Output] Output Unit.	---	---

Signal	Signal name	Function	ON/OFF timing	
			OFF to ON	ON to OFF
GATE	Data Output Completion signal	<p>This signal tells the timing to load the output data of DO0 to DO15 to the User (PLC Link). This signal is ON: means that the data is output from Sensor Controller.</p> <p>Read the data (from the PLC) when this signal turns ON.</p> <p>Depending on the flow that is set, the GATE output may be started while the BUSY signal is ON. The OR signal and GATE signal do not necessarily operate simultaneously.</p>	<ul style="list-style-type: none"> • No Handshaking: The signal turns ON after the FH/FZ5 Sensor Controller executes the Output Unit (Parallel Data Output Unit or Parallel Judgement Output Unit) in the measurement flow^{*1} and preparations for data output have been completed. • Handshaking: The signal turns ON after the FH/FZ5 Sensor Controller executes the Output Unit (Parallel Data Output Unit or Parallel Judgement Output Unit) in the measurement flow,^{*1*2} the Data Output Request (DSA) signal is ON, and preparations for data output have been completed. <p>*1: This occurs when the Output Unit is executed as the measurement flow is executed in order from the top. It does not occur when execution of a measurement is completed.</p> <p>*2: The signal is output if a Parallel Judgement Output or Parallel Data Output processing item is set in the measurement flow.</p>	<ul style="list-style-type: none"> • No Handshaking: The signal turns OFF after the set output time has elapsed. • Handshaking: The signal turns OFF when the user (PLC) turns OFF Data Output Request (DSA) signal.

Signal	Signal name	Function	ON/OFF timing	
			OFF to ON	ON to OFF
READY	Multi-input Ready	<p>This signal tells when the STEP signal can be input when the multi-input function is used.</p> <p>Turn ON the STEP signal when the READY signal turns ON.</p> <p>When using the multi-input function, the next STEP signal is accepted only after the READY signal turns ON (i.e., when image input is completed).</p> <p>*1: If you use a Camera with Lighting Controller, the time required for the READY signal to turn OFF may increase in comparison with not using a Camera with a Lighting Controller. For details, refer to ► <i>Camera Image Input FH or Camera Image Input HDR</i> in the <i>Vision System FH/FZ5 Series Processing Items Reference Manual</i> (Cat. No. Z341).</p>	The signal turns ON when the STEP signal can be input.	<p>The signal turns OFF*1 when the STEP signal cannot be input.</p> <p>*2: When through images are being displayed, the READY signal will turn OFF, but the STEP signal can be input. Determine whether or not the STEP input is allowed based on the BUSY signal.</p>
SHTOUT (FH only)	Shutter Output signal	<p>This signal tells when Camera exposure has been completed.</p> <p>This signal is output only when SHTOUT is selected as the output signal in the output signal settings of the system settings.</p> <ul style="list-style-type: none"> If more than one Camera is connected, the signal will remain ON for the Camera with the longest exposure time. You cannot use the Shutter Output Signal when the image mode is set for a through image. If you have registered more than one Camera Image Input processing unit in the measurement flow, the SHTOUT signal will be turned ON for each Camera Image Input processing unit individually. Therefore, use Camera Switching processing items instead of Camera Image Input processing items in the middle of the measurement flow. 	After the Camera exposure is completed, the signal turns ON after the time set for the [SHTOUT delay] in the output signal settings has elapsed.	The signal turns OFF after the time set for the [SHTOUT width] in the output signal settings has elapsed.
STGOUT	Strobe Trigger Output	This is the trigger signal for the strobe.	After an external trigger input is received, the signal turns ON after the time set for the [STEP-STGOUT delay] in the electronic flash settings has elapsed.	The signal turns OFF after the time that is set for the [STGOUT width] in the electronic flash settings has elapsed.
ACK (FH only)	Command Completion Flag	This flag tells when DI command execution is completed.	The signal turns ON when execution of the DI command is completed.	The signal turns OFF when the user (PLC) turns OFF the DI7 signal.

Signal	Signal name	Function	ON/OFF timing	
			OFF to ON	ON to OFF
ERR	Error Signal	This signal is used for notification when the FH/FZ5 detects one of the errors below. For descriptions of the errors, refer to the following: Refer to ► <i>Error Messages and Troubleshooting</i> in the <i>Vision System FH/FZ5 Series User's Manual</i> (Cat. No. Z365).	ON when the FH detects an error.	After the error is removed, the user (PLC) either performs remeasurement or executes error clear (ERCLR signal: ON) to turn OFF the signal.

Multi-line Random Trigger Mode Signal Specifications

For parallel signals, the supported signals and signal assignments depend on the number of lines used in Multi-line Random-trigger Mode.

The following tables show the differences in signal assignments and the signals that can be used depending on the number of lines.

Refer to ► the *Vision System FH/FZ5 series Hardware Setup Manual* (Cat. No. Z366) for terminal functions and assignments.

FH-1000/FH-3000 series Sensor Controller

• Signals and Assignments According to Number of Lines Used

I/O	Number of lines			
	1 line	2 lines	3 or 4 lines	5 to 8 lines
STEP	Assigned for each line.			
DSA	Assigned for each line.		Not supported.	
DI	The same signal is used for all lines.	The same signal is used for all lines. The DILINE signal (which specifies the line number to send the command) is added.		
ENC (Phase A, Phase B, or Phase Z)	Assigned for each line.		Not supported.	
ACK	The same signal is used for all lines.			
RUN	Assigned for each line.			Not supported.
GATE	Assigned for each line.		Not supported.	
BUSY	Assigned for each line.			
OR	Assigned for each line.			
ERR	Assigned for each line.			The same setting is used for all lines.
READY	Assigned for each line.			
DO	DO0 to DO15	Line 0: DO0 to DO7 Line 1: DO8 to DO15	Not supported.	

• Signals According to Lines Used

Two Lines

I/O	Line number	
	Line 0	Line 1
STEP	STEP0	STEP1
DSA	DSA0	DSA1
DILINE	DILINE 0 (used for all lines)	
DI	DI0 to DI7 (used for all lines)	
ENC (Phase A, Phase B, or Phase Z)	ENC0 Phase A, ENC0 Phase B, or ENC0 Phase Z *When an encoder is used, STEP0 is assigned to ENC0 Phase Z.	ENC1 A Phase, ENC1 B Phase, or ENC1 Z Phase * When an encoder is used, STEP6 is assigned to ENC1 Phase A, STEP7 is assigned to ENC1 Phase B, and STEP1 is assigned to ENC1 Phase Z.
ACK	ACK (used for all lines)	

I/O	Line number	
	Line 0	Line 1
RUN	RUN0	RUN1
GATE	GATE0	GATE1
BUSY	BUSY0	BUSY1
OR	OR0	OR1
ERR	ERR0	ERR1
READY	READY0	READY1
DO	DO0 to DO7	DO8 to DO15

Three or Four Lines

I/O	Line number			
	Line 0	Line 1	Line 2	Line 3
STEP	STEP0	STEP1	STEP2	STEP3
DSA	---			
DILINE	DILINE 0 to DILINE 1 (used for all lines) *DSA0 is assigned to DILINE1.			
DI	DI0 to DI7 (used for all lines)			
ENC (Phase A, Phase B, or Phase Z)	---			
ACK	ACK (used for all lines)			
RUN	RUN0	RUN1	RUN2	RUN3
GATE	---			
BUSY	BUSY0	BUSY1	BUSY2	BUSY3
OR	OR0	OR1	OR2	OR3
ERR	ERR0	ERR1	ERR2	ERR3
READY	READY0	READY1	READY2	READY3
DO	---			

Five to Eight Lines

I/O	Line number							
	Line 0	Line 1	Line 2	Line 3	Line 4	Line 5	Line 6	Line 7
STEP	STEP0	STEP1	STEP2	STEP3	STEP4	STEP5	STEP6	STEP7
DSA	---							
DILINE	DILINE 0 to DILINE 2 (used for all lines) *DSA0 is assigned to DILINE1 and DSA1 is assigned to DILINE2.							
DI	DI0 to DI7 (used for all lines)							
ENC (Phase A, Phase B, or Phase Z)	---							
ACK	ACK (used for all lines)							
RUN	---							
GATE	---							

I/O	Line number							
	Line 0	Line 1	Line 2	Line 3	Line 4	Line 5	Line 6	Line 7
BUSY	BUSY0	BUSY1	BUSY2	BUSY3	BUSY4	BUSY5	BUSY6	BUSY7
OR	OR0	OR1	OR2	OR3	OR4	OR5	OR6	OR7
ERR	ERR (used for all lines)							
READY	READY0	READY1	READY2	READY3	READY4	READY5	READY6	READY7
DO	---							

FZ5-800/FZ5-1100/FZ5-1200 series Sensor Controller

• Signals and Assignments According to Number of Lines Used

I/O	Number of lines	
	1 line	2 lines
STEP	Assigned for each line.	
DSA	Assigned for each line.	
DI	The same setting is used for all lines.	
RUN	RUN	Not supported.
GATE	Assigned for each line.	
BUSY	Assigned for each line. *RUN is assigned to BUSY1.	
OR	Assigned for each line.	
ERR	The same setting is used for all lines.	
READY	Assigned for each line.	
DO	DO0 to DO15	Line0: DO0 to DO7 Line1: DO8 to DO15

• Signals According to Lines Used

I/O	Line number	
	Line 0	Line 1
STEP	STEP0	STEP1
DSA	DSA0	DSA1
DI	DI0 to DI7	DI0 to DI7
RUN	No output	
GATE	GATE0	GATE1
BUSY	BUSY	RUN
OR	OR0	OR1
ERR	ERR (shared)	
READY	READY0	READY1
DO	DO0 to DO7	DO8 to DO15

STEP Signal Input Timing

The measurement trigger STEP signal is input with the following timing.

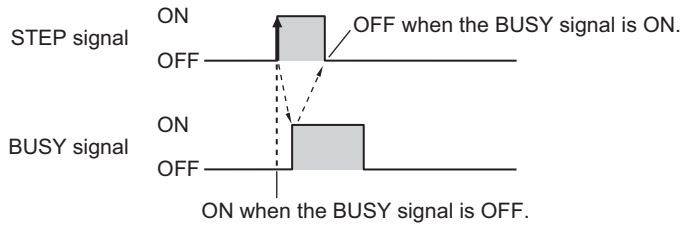

1 Turn ON the STEP signal when the BUSY signal is OFF.

When multiple inputs are used, the STEP signal can be turned ON when the READY signal is ON. However, if the image mode is set to Through Mode, the READY signal will always be OFF, so check the status of the BUSY signal to determine when to input the STEP signal.

2 Check that the BUSY signal is ON, then turn OFF the STEP signal.

Note

If the STEP signal is turned ON when the READY signal is OFF, no measurements will be executed and the ERROR signal will turn ON.

DI0 to DI7 (Command Execution) Timing

• FH

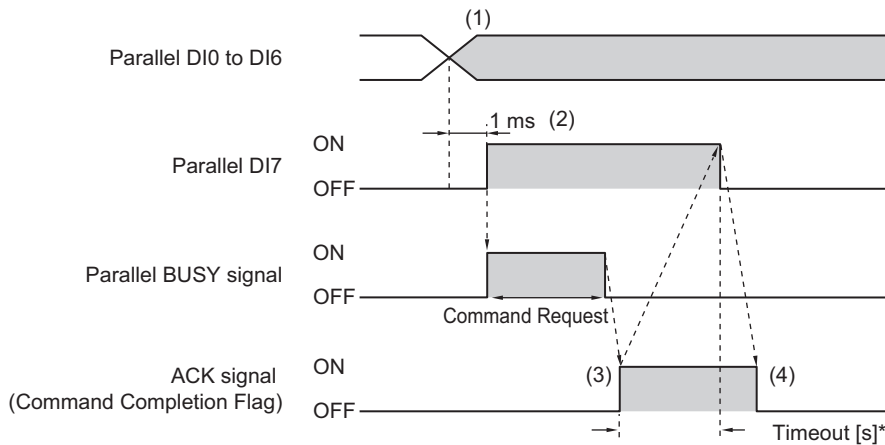

When executing continuous measurement commands, turn OFF DI7 when you want to stop continuous measurements, as shown below.

For continuous measurement commands, the ACK signal will remain OFF.

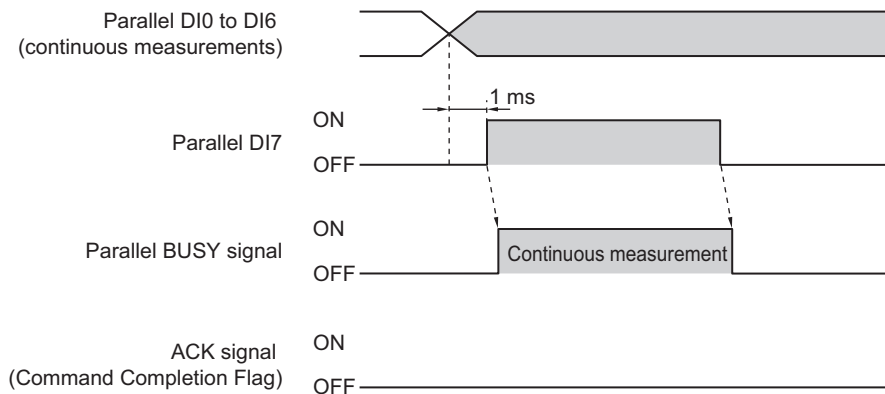

- 1** Set the DI0 to DI6 signals to ON or OFF based on the command to input.
- 2** After you have set the DI0 to DI6 signals, wait for at least 1 ms and then turn ON DI7.
- 3** The command will be executed, and the ACK signal will turn ON after execution of the command is completed.
- 4** Check that the ACK signal has turned ON, then turn OFF DI7.

When the DI7 signal is turned OFF, the ACK signal will turn OFF.

*: A timeout error will occur if the DI7 signal is not turned OFF within the set timeout interval from when the ACK signal is turned ON.

IMPORTANT

If the DI7 is still ON after execution of a command is completed, the same command will be executed again. Confirm that the ACK signal is turned ON from OFF, and then create the program of th PLC side to turn the DI17 signal OFF from ON.

Note

From the PLC, set signals DI0 to DI6 and turn ON the DI7 signal only when the BUSY, ACK, and DI7 signals are all OFF. From the PLC, you can check if a command was acknowledged by confirming that the BUSY signal turned ON. From the PLC, you can check if execution of a command was completed by confirming that the ACK signal turned ON. After these conditions have all been met, turn OFF the DI7 signal.

• FZ5

Sensor control commands are input with the timing shown below using the DI0 to DI7 signals.

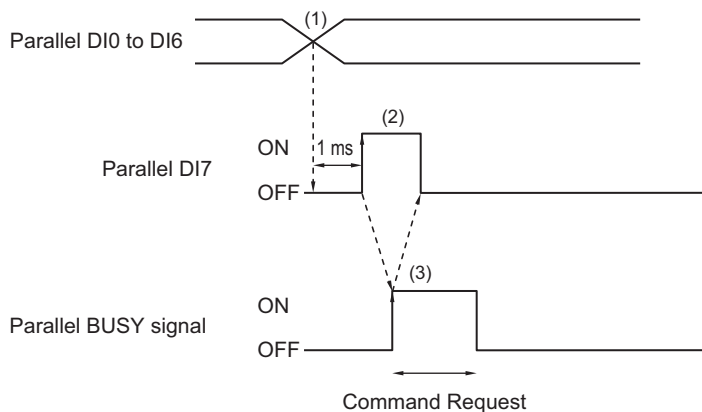

- (1) Set the DI0 to DI6 signals to ON or OFF based on the command to input.
- (2) After you have set the DI0 to DI6 signals, wait for at least 1 ms and then turn ON DI7.
- (3) Then check that the BUSY signal has turned ON, then turn OFF DI7. The BUSY signal is turned OFF when execution of the command is completed. When executing continuous measurement commands, turn OFF DI7 when you want to stop continuous measurements.

IMPORTANT

If the DI7 is still ON after execution of a command is completed, the same command will be executed again.

Note

From the PLC, set signals DI0 to DI6 and turn ON the DI7 signal only when the BUSY and DI7 signals are OFF. The PLC (user) turns OFF the DI7 signal after checking that the BUSY signal has turned ON.

Output Items

Parallel Data Output

Measurement Results for Which Output Is Possible (Parallel Data Output)

You can use the processing items that are related to outputting results to output the following data. You can also access measured values from the Calculation or other processing units.

Measured item	Text string	Description
Judgement	JG	Judgement result
Data 0 to 7	D00 to D07	Results of expressions set for output data 0 to 7

External Reference Tables (Parallel Data Output)

By specifying a number, the following data can be referenced from control commands or processing items that have a set/get unit data function.

Number	Data name	Set/Get	Data range
0	Judgement	Get only	0: No judgement (unmeasured) 1: Judgement result OK -1: Judgement result NG
5 to 12	Data 0 to Data 7	Get only	BCD: -999 to 999 Binary: -32768 to 32767
128	Data type	Set/Get	0: Binary, 1: BCD

Parallel Judgement Output

Measurement Results for Which Output Is Possible (Parallel Judgement Output)

You can use the processing items that are related to outputting results to output the following data. You can also access measured values from the Calculation or other processing units.

Measured item	Text string	Description
Judgement	JG	Judgement result
Data 0 to 15	D00 to D15	Results of expressions set for output judgement data 0 to 15
Judge 0 to 15	J00 to J15	Results of judgement on expressions set for output judgement data 0 to 15

External Reference Tables (Parallel Judgement Output)

By specifying a number, the following data can be referenced from control commands or processing items that have a set/get unit data function.

Number	Data name	Set/Get	Data range
0	Judgement	Get only	0: No judgement (unmeasured) 1: Judgement result OK -1: Judgement result NG
5 to 20	Data 0 to Data 15	Get only	-999999999.9999 to 999999999.9999
21 to 36	Judge 0 to Judge 15	Get only	1: OK, -1: NG, 0: Unmeasured
103	Reflect to the overall judgement	Set/Get	0: ON, 1: OFF
136	Upper limit 0 for judgement	Set/Get	-999999999.9999 to 999999999.9999
137	Lower limit 0 for judgement	Set/Get	-999999999.9999 to 999999999.9999

Number	Data name	Set/Get	Data range
138	Upper limit 1 for judgement	Set/Get	-999999999.9999 to 999999999.9999
139	Lower limit 1 for judgement	Set/Get	-999999999.9999 to 999999999.9999
140	Upper limit 2 for judgement	Set/Get	-999999999.9999 to 999999999.9999
141	Lower limit 2 for judgement	Set/Get	-999999999.9999 to 999999999.9999
142	Upper limit 3 for judgement	Set/Get	-999999999.9999 to 999999999.9999
143	Lower limit 3 for judgement	Set/Get	-999999999.9999 to 999999999.9999
144	Upper limit 4 for judgement	Set/Get	-999999999.9999 to 999999999.9999
145	Lower limit 4 for judgement	Set/Get	-999999999.9999 to 999999999.9999
146	Upper limit 5 for judgement	Set/Get	-999999999.9999 to 999999999.9999
147	Lower limit 5 for judgement	Set/Get	-999999999.9999 to 999999999.9999
148	Upper limit 6 for judgement	Set/Get	-999999999.9999 to 999999999.9999
149	Lower limit 6 for judgement	Set/Get	-999999999.9999 to 999999999.9999
150	Upper limit 7 for judgement	Set/Get	-999999999.9999 to 999999999.9999
151	Lower limit 7 for judgement	Set/Get	-999999999.9999 to 999999999.9999
152	Upper limit 8 for judgement	Set/Get	-999999999.9999 to 999999999.9999
153	Lower limit 8 for judgement	Set/Get	-999999999.9999 to 999999999.9999
154	Upper limit 9 for judgement	Set/Get	-999999999.9999 to 999999999.9999
155	Lower limit 9 for judgement	Set/Get	-999999999.9999 to 999999999.9999
156	Upper limit 10 for judgement	Set/Get	-999999999.9999 to 999999999.9999
157	Lower limit 10 for judgement	Set/Get	-999999999.9999 to 999999999.9999
158	Upper limit 11 for judgement	Set/Get	-999999999.9999 to 999999999.9999
159	Lower limit 11 for judgement	Set/Get	-999999999.9999 to 999999999.9999
160	Upper limit 12 for judgement	Set/Get	-999999999.9999 to 999999999.9999
161	Lower limit 12 for judgement	Set/Get	-999999999.9999 to 999999999.9999
162	Upper limit 13 for judgement	Set/Get	-999999999.9999 to 999999999.9999
163	Lower limit 13 for judgement	Set/Get	-999999999.9999 to 999999999.9999
164	Upper limit 14 for judgement	Set/Get	-999999999.9999 to 999999999.9999
165	Lower limit 14 for judgement	Set/Get	-999999999.9999 to 999999999.9999
166	Upper limit 15 for judgement	Set/Get	-999999999.9999 to 999999999.9999
167	Lower limit 15 for judgement	Set/Get	-999999999.9999 to 999999999.9999

Command Formats

You can input commands to control the Sensor from an external device using the DI0 to DI7 signals.

Input Format

Commands are input in the following formats.

FH

- **One Line**

Input format (DI7 to DI0)

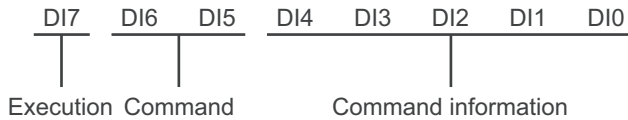

Set 0 (OFF) or 1 (ON) for each DI signal.

Confirm commands and information, and turn DI7 (execute) ON with an interval of at least 1 ms.

- **Multi-line Random-trigger Mode**

2 lines

Input format (DI7 to DI0 and DILINE0)

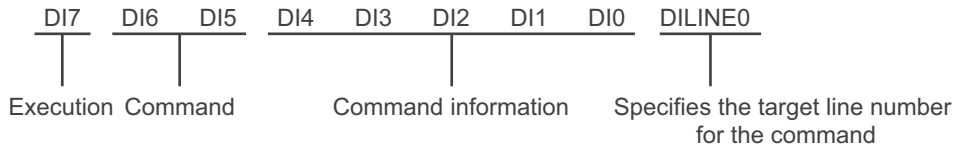

Three or Four Lines

Input format (DI7 to DI0, DILINE1, and DILINE0)

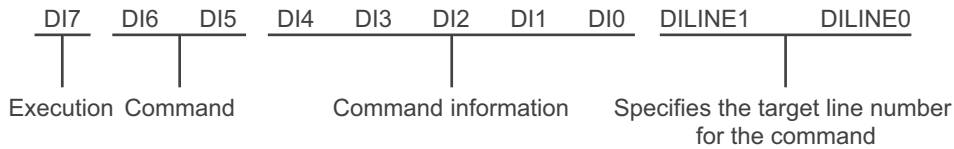

Five to Eight Lines

Input format (DI7 to DI0 and DILINE2 to DILINE0)

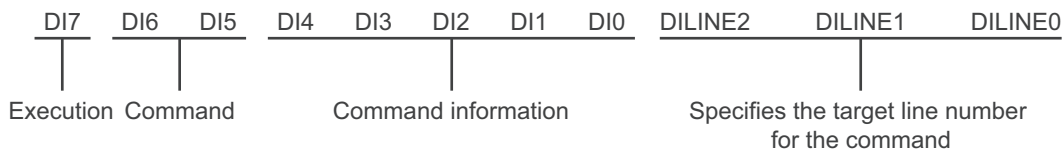

FZ5

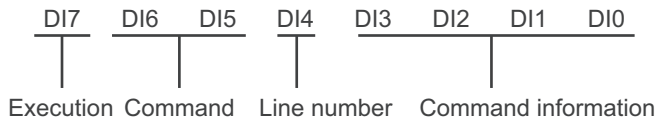

Command Lists

The commands and command formats are described in the following tables.

One Line

Data	Description	Input format (DI7 to DI0)			Input example
		Execute (DI7)	Command (DI6, DI5)	Command information (DI4 to DI0)	
Continuous Measurement	Performs measurement continuously while command is being input.	1	00	***** The Controller does not see this signal, so a setting of either 0 or 1 makes no difference.	Input example: 10000000
Select Scene	Changes the measurement scene.	1	01	Input [Scene No.] in binary format (0 to 31).	Switching to Scene 2 Input example: 10100010
Set Scene Group	Changes the measurement scene groups.	1	11	Input [Scene Group No.] in binary format (0 to 31).	Changing to Scene Group 2 Input example: 11100010
Clear Measurement Values	Clears measurement values. The OR signal and DO signal are not cleared.	1	10	00000	Input example: 11000000
Clear Error	Clears the error output. The ERROR indicator is also cleared.	1	10	00001	Input example: 11000001
Clear Parallel OR+DO	Clears the OR signal and DO signal.	1	10	00010	Input example: 11000010
Wait State Clear	Clears the wait state in the control flow parallel processing unit.	1	10	01111	Input example: 11001111

0: OFF

1: ON

Multi-line Random Trigger Mode

FH

Data	Description	Input format (DI7 to DI0, DILINE0, DILINE1, and DILINE2)				Input example (DILINE2 to DILINE0, DI7 to DI5, and DI4 to DI0)
		Execute (DI7)	Command (DI6, DI5)	Command information (DI4 to DI0)	Line number*1	
Continuous Measurement	Performs measurement continuously while command is being input.	1	00	***** The Controller does not see this signal, so a setting of either 0 or 1 makes no difference.		Continuous measurements on line 1 when 2 lines are used Input example: 0 100 00000
Select Scene	Changes the measurement scene.	1	01	Input [Scene No.] in binary format (0 to 31).	Specify the line number to send the command to. • Two lines: 0 or 1 • Three or four lines: 00 (line 0) 01 (line 1) 10 (line 2) 11 (line 3) • Five to eight lines: 000 (line 0) 001 (line 1) 010 (line 2) 011 (line 3) 100 (line 4) 101 (line 5) 110 (line 6) 111 (line 7)	Changing to scene 2 on line 2 when 4 lines are used Input example: 10 101 00010
Set Scene Group	Changes the measurement scene groups.	1	11	Input [Scene Group No.] in binary format (0 to 31).		Changing to scene group 3 on line 6 when 8 lines are used Input example: 110 111 00011
Clear Measurement Values	Clears measurement values. The OR signal and DO signal are not cleared.	1	10	00000		Clearing the measurement results for line 1 when 2 lines are used Input example: 1 110 00000
Clear Error	Clears the error output. The ERROR indicator is also cleared.	1	10	00001		Clearing the error status for line 1 when 4 lines are used Input example: 01 110 00001
Clear Parallel OR+DO	Clears the OR signal and DO signal. *2	1	10	00010		Clearing the OR and DO signals for line 2 when 8 lines are used Input example: 010 110 00010
Wait State Clear	Clears the wait state in the control flow parallel processing unit.	1	10	01111		11001111

*1: Two lines: DILINE0
Three or four lines: DILINE0 and DILINE1
Five to eight lines: DILINE0 to DILINE2

*2: Only the signals assigned to the line that the command was sent to can be cleared. The OR and DO signals are not cleared for other lines. If the command is sent to a line that cannot use the DO signals, only the OR signal will be cleared.

Data	Description	Input format (DI7 to DI0)				Input example
		Execute (DI7)	Command (DI6, DI5)	Line number (DI4)	Command information (DI3 to DI0)	
Continuous Measurement	Performs measurement continuously while command is being input.	1	00	0 or 1 Specify the line number to send the command to.	***** The Controller does not see this signal, so a setting of either 0 or 1 makes no difference.	Continuous Measurement on Line 1 Input example: 10010000
Select Scene	Changes the measurement scene.	1	01		Input [Scene No.] in binary format (0 to 15).	Changing Line 0 to Scene 2 Input example: 10100010
Set Scene Group	Changes the measurement scene groups.	1	11		Input [Scene Group No.] in binary format (0 to 15).	Changing Line 1 to Scene Group 2 Input example: 11110010
Clear Measurement Values	Clears measurement values. The OR signal and DO signal are not cleared.	1	10		0000	Clearing the Measurement Values of Line 1 Input example: 11010000
Clear Error	Clears the error output. The ERROR indicator is also cleared. *1	1	10		0001	Clearing ERR (Common)* Input example: 11000001
Clear Parallel OR+DO	Clears the OR signal and DO signal.	1	10		0010	Clearing the OR Signal and DO Signal of Line 1 Input example: 11010010
Wait State Clear	Clears the wait state in the control flow parallel processing unit.	1	10		1111	11001111

*1: To clear ERR (common) for an FZ5-series Controller, set the line number (DI4) to 0.

Time Charts

The ON/OFF timing of related signals during data output after the completion of measurement and during the sequence of operation from input of the control command until data output after the completion of measurement is indicated below in a timing chart.

Timing chart at startup

This section explains the timing chart at startup.

IMPORTANT

- Refer to ► I/O Signals (p.320) for details on functions and operation of each signal.
- Input the STEP signals and DI0 to DI7 signals after the RUN signal turns ON.

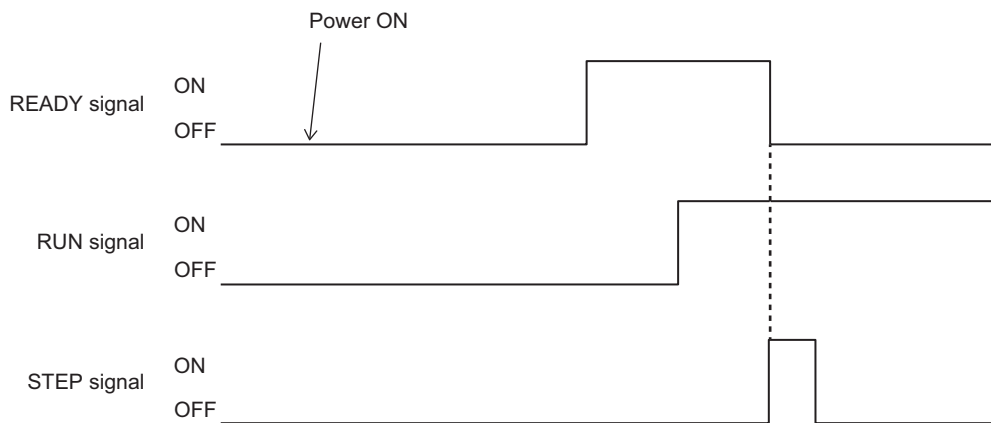

- 1** Turn ON power.
- 2** The READY signal turns ON when the trigger signal becomes acceptable.
- 3** The STEP signal is input after checking the RUN signal is ON.

Output Control Timing Charts

This section provides timing charts for each output control type (none, handshaking, and synchronization output).

IMPORTANT

For the function and operation of each signal, refer to ► I/O Signals (p.320).

Output Control: None

Example: Three Data Items Set for Parallel Data Output

Time Chart

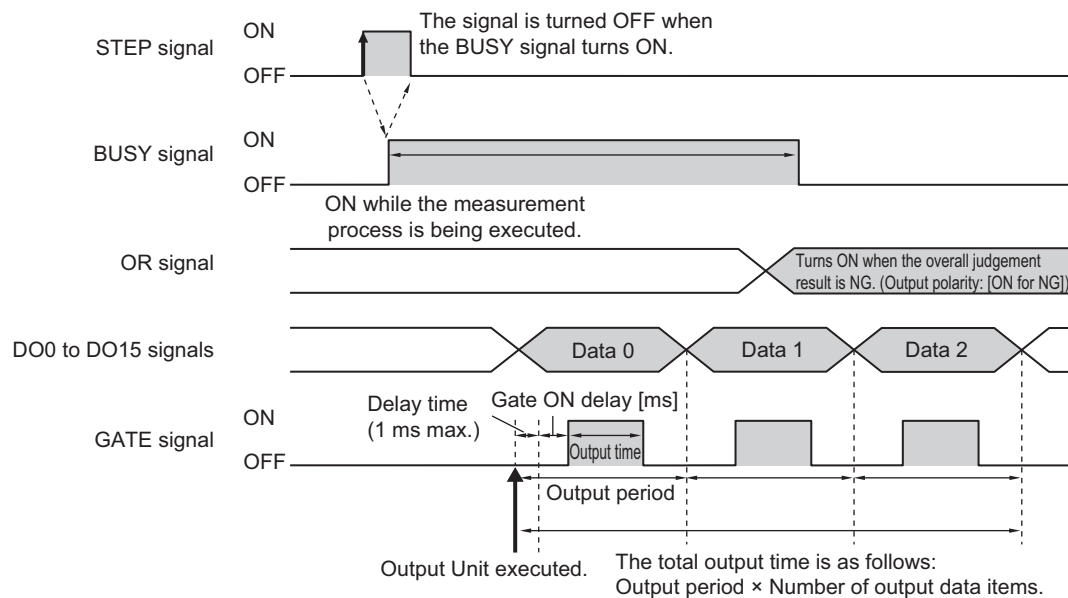

- 1** Turn ON the STEP signal while the BUSY signal is OFF.
- 2** Measurement begins and the BUSY signal is turned ON during the measurement process.
- 3** Measurement data is output when a Parallel Data Output Unit in the measurement flow is executed.
- 4** After the data output processing, the GATE signal is turned ON after the time set for the [Gate ON delay] in the parallel communications settings has elapsed.*1*2
- *1: A delay of up to 1 ms will occur when the GATE signal is turned ON. (This applied only to the FH.)
- 5** After the GATE signal is turned ON, the GATE signal is turned OFF after the time set for the [Output time] in the parallel communications settings has elapsed.*2
- 6** If the processing for the next data item is completed, the next GATE signal is turned ON after the time set for the [Output period] has elapsed from the end of processing in step 5 above.
- *2: Set the GATE ON delay and output time for the GATE signal so that the total time does not exceed the output period.
- 7** After measurement is completed, the OR signal is output based on the measurement result and the BUSY signal is turned OFF.

IMPORTANT

Data Output Time and STEP Signal Input Interval

Set the input interval for the STEP signal so that it is longer than the total output time. If the STEP signal input interval is shorter than the total output time, the data output buffer will eventually overflow and data will be lost.

Note

When the Parallel Judgment Output unit is executed, the GATE signal turns ON once.

Output Control: Handshaking

Example: Three Data Items Set for Parallel Data Output

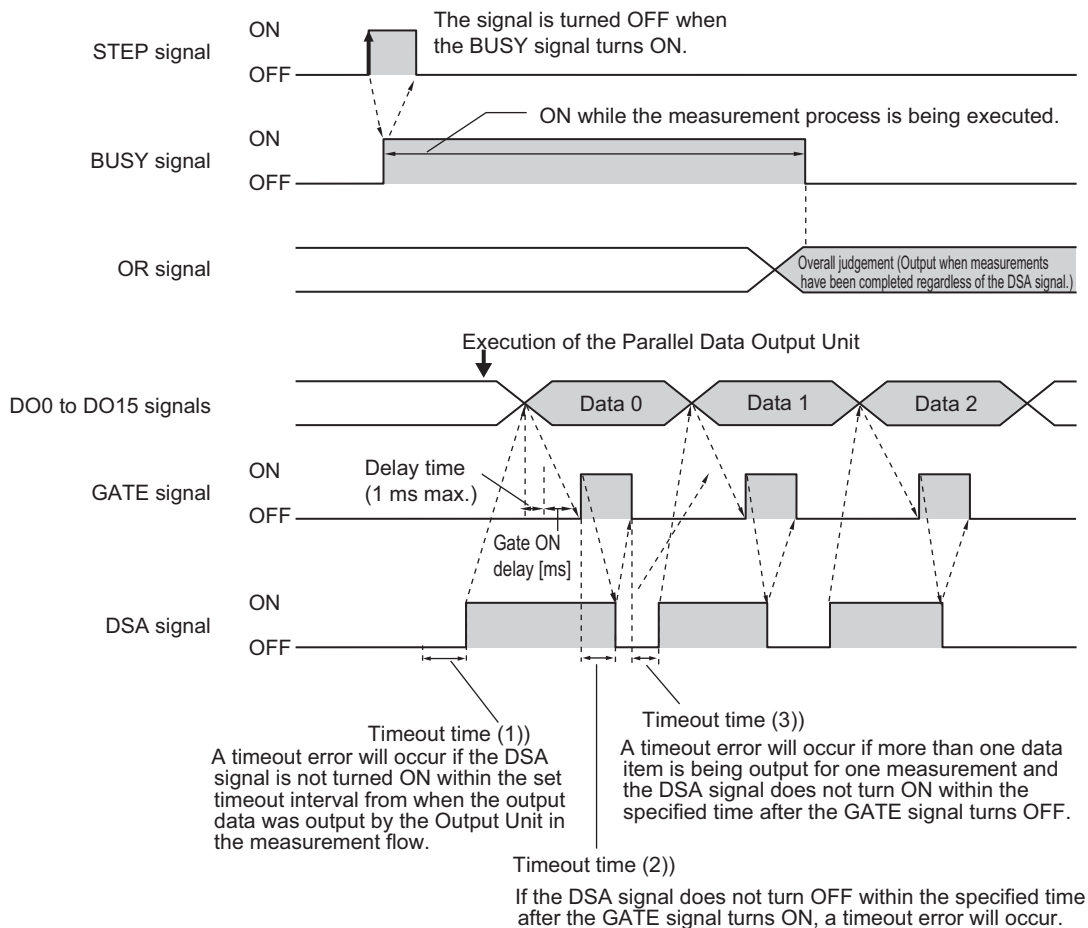

- 1** Turn ON the STEP signal while the BUSY signal is OFF.
- 2** Measurement begins and the BUSY signal is turned ON during the measurement process.
- 3** Turn ON the DSA signal from the external device to request data transmission after the STEP signal turns ON.*¹
 - *1: A timeout error will occur if the DSA signal is not turned ON within the set timeout interval from when the output data was output by the Output Unit in the measurement flow. (1)
- 4** After measurement is completed, the OR signal is output based on the measurement result and the BUSY signal is turned OFF.
- 5** Measurement data is output when a Parallel Data Output Unit in the measurement flow is executed.
- 6** The GATE signal is turned ON if the DSA signal is ON after data output processing.*²
 - *2: A delay of up to 1 ms will occur when the GATE signal is turned ON. (This applied only to the FH.)
- 7** The user (PLC) reads the data and turns OFF the DSA signal when the GATE signal turns ON.
- 8** The GATE signal turns OFF if the DSA signal is turned OFF.*³
 - *3: If you do not turn OFF the DSA signal within the specified timeout time after the GATE signal turns ON, a timeout error will occur. (2)
- 9** If more than one data item is being output for one measurement and you do not turn ON the DSA signal within the specified timeout time after the GATE signal turns OFF, a timeout error will occur. (3)

Note

When the Parallel Judgment Output unit is executed, after Data Output processing, while the DSA signal is ON, the GATE signal turns ON once.

Output Control: Synchronization Control

Operation When [Number of Delay] Is Set to 2

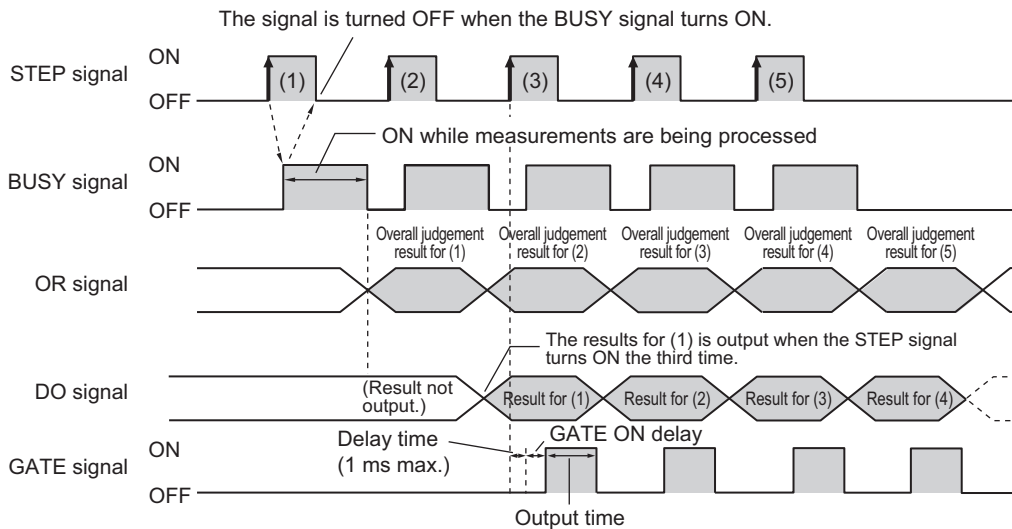

- 1** Repeatedly turn ON the STEP signal while the BUSY signal is OFF.
 - 2** The Overall Judgment (OR) signal is output when BUSY signal is turned from ON to OFF.
 - 3** When the STEP signal turns ON for the third time, the measurement results (DO) for the first time that the STEP signal turned ON are output and the GATE signal is turned ON after the time set for the GATE ON delay has elapsed.
 - 4** When the STEP signal turns ON for the fourth time, the measurement results (DO) for the second time that the STEP signal turned ON are output and the GATE signal is turned ON after the time set for the GATE ON delay has elapsed.*¹
- *1: A delay of up to 1 ms will occur when the GATE signal is turned ON. (This applied only to the FH.)
- 5** Each time the STEP signal turns ON after that, the measurement result (DO) from when the STEP signal turned ON two times previously is output.

Note

For the function and operation of each signal, refer to ► I/O Signals (p.320).

Continuous Measurement

Measurements are performed continuously while the DI7 signal is ON.
Continuous measurements are stopped when the DI7 signal is turned OFF.

When an Expressions Is Set in [Parallel Data Output] with No Output Control

• Time Chart

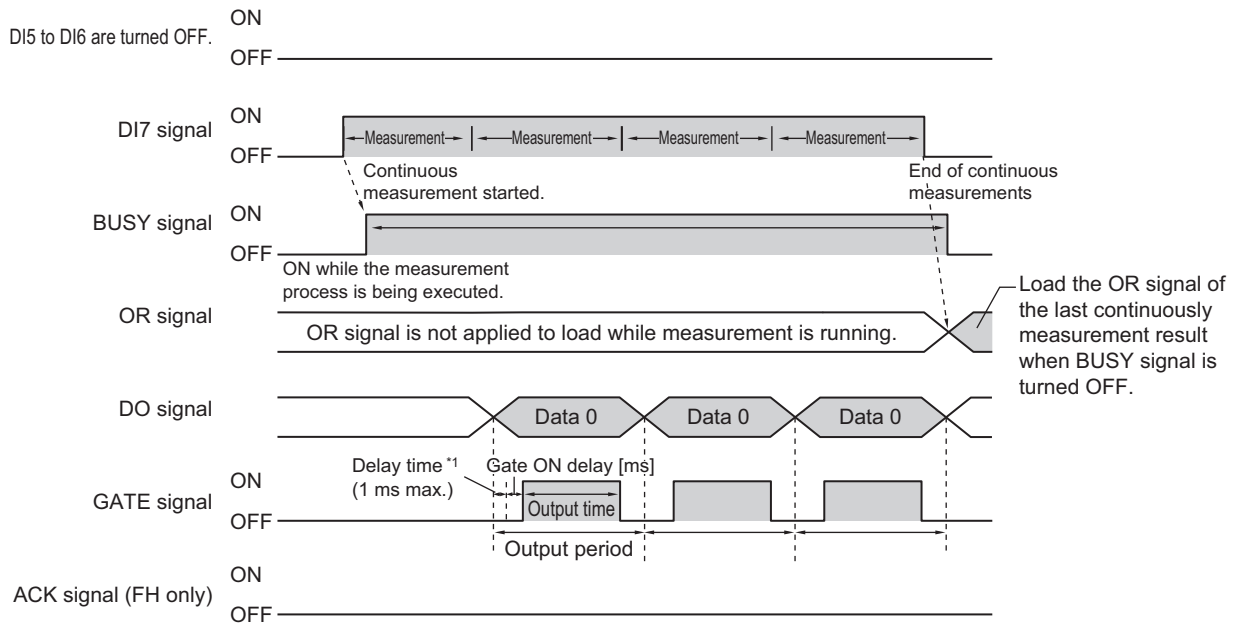

*1 A delay of up to 1 ms will occur when the GATE signal is turned ON. (This applied only to the FH.)

• Input Signals

Signal	Description
DI5 to DI6	These signals are turned OFF during continuous measurements (i.e., when DI7 is ON).
DI7	This is the execution trigger. After DI0 to DI6 are set, turn ON DI7 after an interval over 1 ms. Always keep this signal turned ON during a continuous measurement. Continuous measurement is stopped when this signal is turned OFF.

IMPORTANT

- The measurements during continuous measurements are given priority. Therefore, display of the measurement results (overall judgement, images, judgement for each processing unit in the flow display, and detailed results) may sometimes not be updated.
- When continuous measurements are ended, the measurement results from the last measurement will be displayed.
- OR signal is not applied to load while measurement is running. When you want to get the Overall judgment result during measurement, assign TJG to the [Parallel Data Output] or [Parallel Judgment Output]. (Reference: ► Basic Control Operations of the Sensor Controller (p.14))
- Load the OR signal of the last continuously measurement result when BUSY signal is turned OFF.

Note

- When the input command is not received correctly, the ERROR signal turns ON.
- Acquisition is difficult because the amount of time during which the BUSY signal is OFF during a continuous measurement for a parallel command is extremely short (1 ms or less). Get the OR signal when the GATE signal turns ON after adding the parallel judgement output at the end of the flow.

Scene/Scene Group Switch

Scenes and scene groups are changed as follows.

When the number of the desired scene or scene group is set in DI0 to DI6 and DI7 is turned ON, the scene or scene group changes to that set in DI0 to DI6.

• **Time Charts**

FH

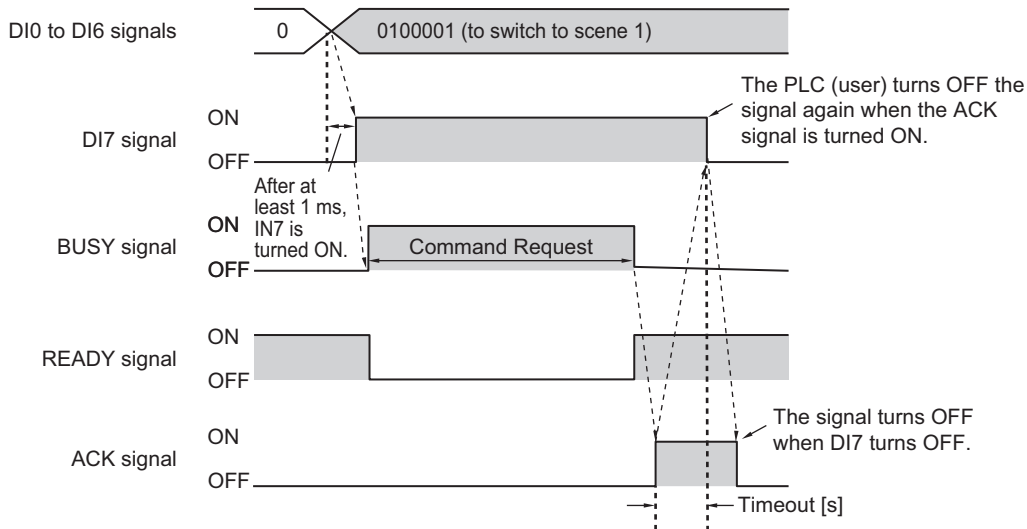

FZ5

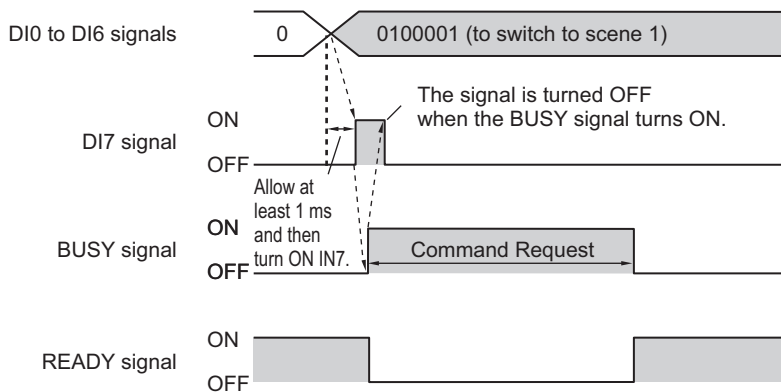

• Output Signals

Signal	Description
BUSY	Indicates that the Controller is currently switching the scene or scene group. Do not input next command while the BUSY signal is ON. Otherwise, on-going processing or commands that are input will not be performed correctly.
READY	Turns OFF while a scene or a scene group is being switched. Turns OFF as long as the BUSY signal is ON.
ACK (FH only)	Turn ON when execution of the DI command is completed.

Note

When the input command is not received correctly, the ERROR signal turns ON.

IMPORTANT

Do not change the scene group during parallel continuous measurement or when the STEP signal is being input continuously. If you must change the scene group at one of these times, set [Unchecked] in [Save scene group on scene switch] in either of the settings items below.

Refer to ► *Changing the Scene or Scene Group* in the *Vision System FH/FZ5 Series User's Manual* (Cat. No. Z365).

Refer to ► *Setting the Conditions That Are Related to Operation during Measurement* in the *Vision System FH/FZ5 Series User's Manual* (Cat. No. Z365).

• Input Signals (Scene/Scene Group Switching)

Signal	Description
DI0 to DI4	Set the scene number (0 to 31). When a DI terminal offset is set, the set offset is added.
DI5	ON
DI6	Select Scene: OFF Set Scene Group: ON
DI7	This is the execution trigger. After DI0 to DI6 are set, turn ON DI7 after an interval over 1 ms. The BUSY signal is ON during command execution. After checking that the BUSY signal has turned ON, turn DI7 OFF, and then turn DI0 to DI6 OFF. If the DI7 signal OFF timing cannot be set faster than the BUSY signal OFF timing on the control side, set the scene switching additional time to lengthen the BUSY signal OFF timing. Refer to ► <i>Setting the Conditions That Are Related to Operation during Measurement</i> in the <i>Vision System FH/FZ5 Series User's Manual</i> (Cat. No. Z365).

Note

The amount of time during which the BUSY signal is turned ON when a scene is switched can be changed.

Select [Measurement setting] from the [Measure] menu and make the setting in the conditions related to operation during measurement.

Refer to ► *Setting the Conditions That Are Related to Operation during Measurement* in the *Vision System FH/FZ5 Series User's Manual* (Cat. No. Z365).

Clear Measurement Values

The measurement result is cleared as follows.

• Time Charts

FH

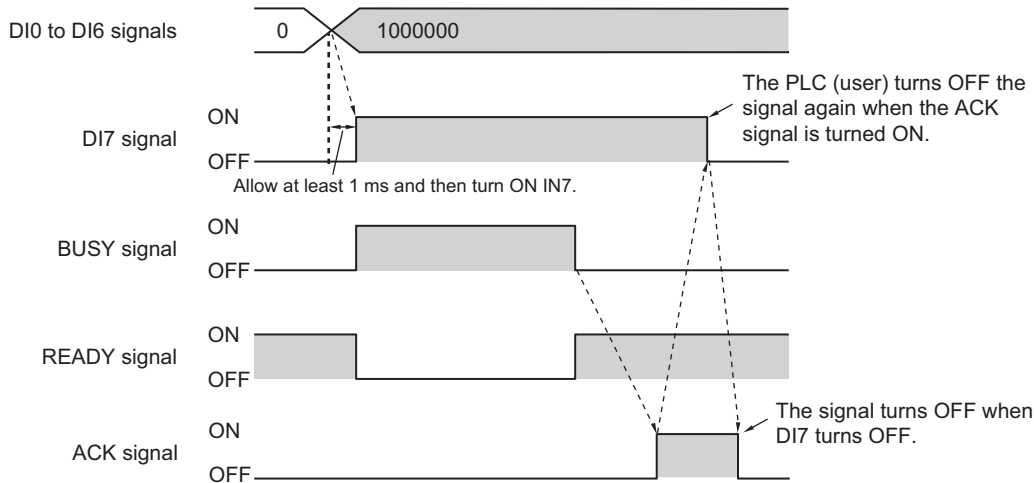

FZ5

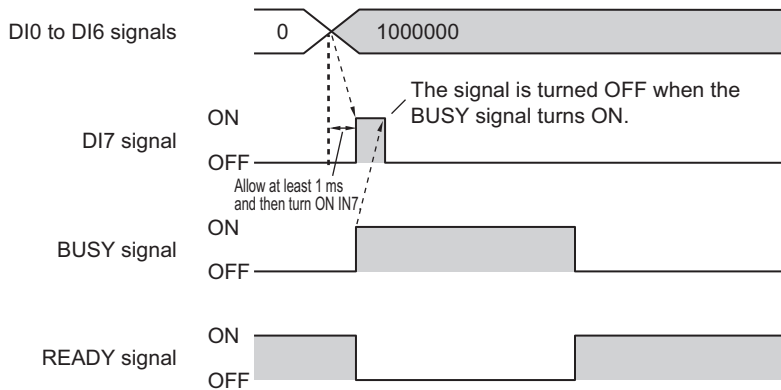

• Output Signals

Signal	Description
READY	Turns OFF when the command to clear the measurement value is being executed. Turns OFF as long as the BUSY signal is ON.
BUSY	Turns ON when the measurement value is being cleared. The amount of time during which the BUSY signal is turned ON is approximately 1 ms.
ACK (FH only)	Turn ON when execution of the DI command is completed.

• **Input Signals**

Signal	Description
DI0 to DI4	Turn OFF.
DI5	Turn OFF.
DI6	Turn ON.
DI7	<p>This is the trigger signal to clear a measurement value.</p> <p>After DI0 to DI6 are set, turn ON DI7 after an interval over 1 ms.</p> <p>The BUSY signal is ON during command execution. After checking that the BUSY signal has turned ON, turn DI7 OFF, and then turn DI0 to DI6 OFF. Note, however, that the amount of time during which the BUSY signal is turned ON is approximately 1 ms. If it cannot be recognized whether the BUSY signal is turned ON or not by an external device, control the timing so that the DI7 signal is turned ON for approximately 5 ms.</p>

Clear Parallel OR+DO

The OR signal and DO signals are cleared as follows.

• Time Chart

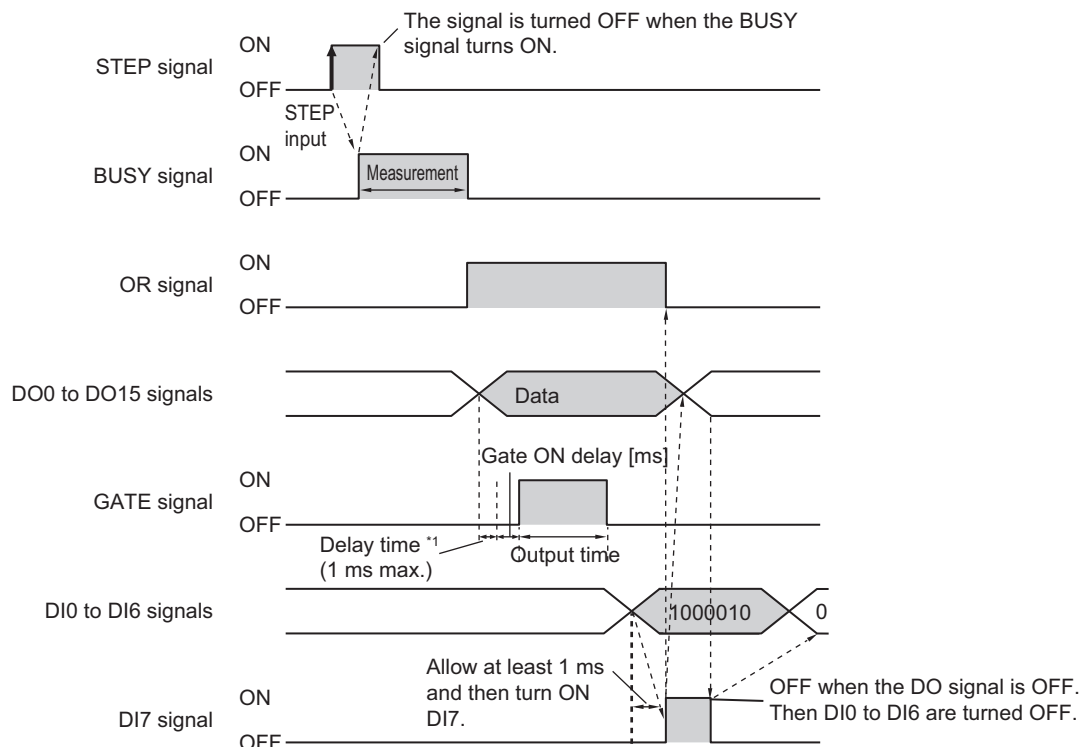

*1 A delay of up to 1 ms will occur when the GATE signal is turned ON. (This applied only to the FH.)

• Output Signals

Signal	Description
READY	This does not change when the OR and DO signal is being cleared. Do not, however, clear the OR and DO signal when the READY signal is turned OFF. The command will not be executed correctly.
BUSY	This does not change when the OR and DO signal is being cleared. Do not, however, clear the OR and DO signal when the BUSY signal is turned ON. The command will not be executed correctly.
OR	It will turn OFF if it was turned ON.
DO0 to DO15	It will turn OFF if it was turned ON.
GATE	This does not change when the OR and DO signal is being cleared. Do not, however, clear the OR and DO signal when the GATE signal is turned ON. The command will not be executed correctly. Or, the DO and GATE will not be output correctly.

• Input Signals

Signal	Description
DI0	Turn OFF.
DI1	Turn ON.
DI2 to DI5	Turn OFF.
DI6	Turn ON.
DI7	This is the trigger signal to clear the OR and DO signal. After DI0 to DI6 are set, turn ON DI7 after an interval over 1 ms. After checking that the OR DO signal has turned OFF, turn DI7 OFF, and then turn DI0 to DI6 OFF.

Clear Error

The error signal is cleared as follows.

• Time Chart

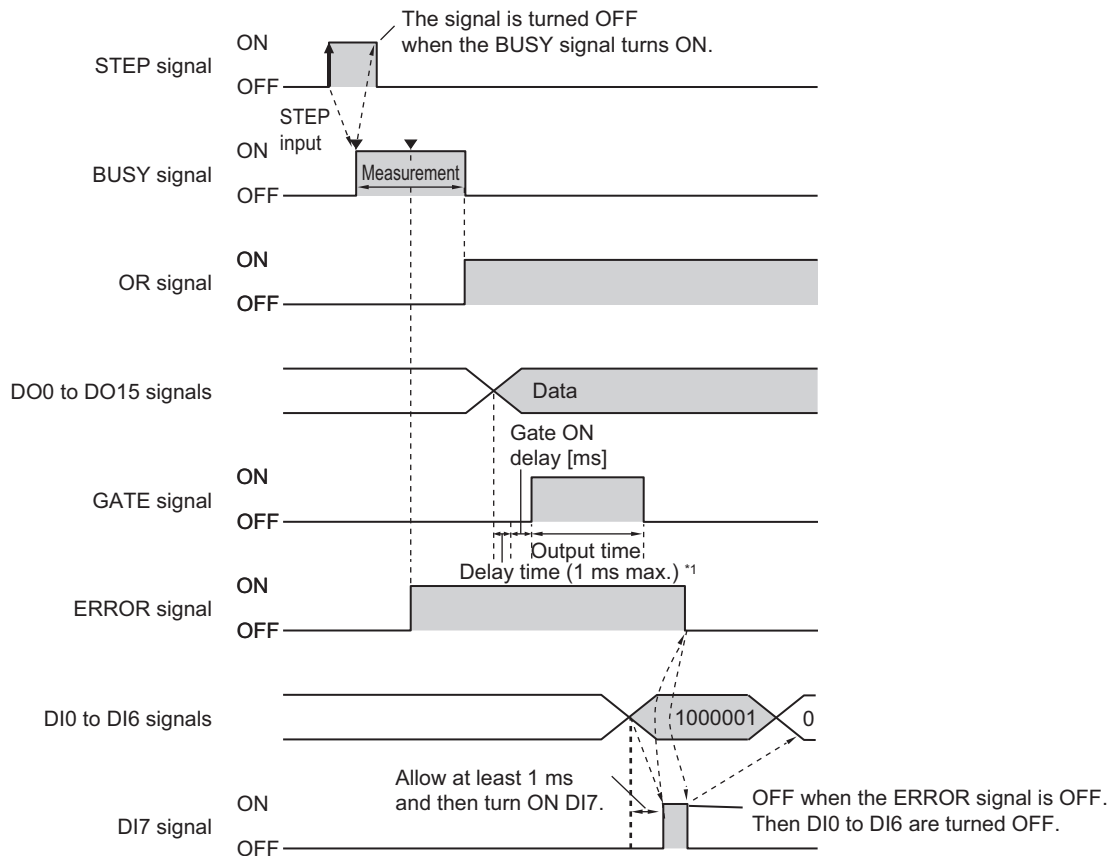

*1 A delay of up to 1 ms will occur when the GATE signal is turned ON. (This applied only to the FH.)

• Output Signals

Signal	Description
READY	This does not change when an error is being cleared. Do not, however, clear the error signal when the READY signal is turned OFF. The command will not be executed correctly.
BUSY	This does not change when an error is being cleared. Do not, however, clear an error when the BUSY signal is turned ON. The command will not be executed correctly.
OR	This does not change when an error is being cleared.
DO0 to DO15	This does not change when an error is being cleared.
GATE	This does not change when an error is being cleared.
ERROR	After the error is removed, the signal turns OFF when the user (PLC) executes the error clear processing.

• Input Signals

Signal	Description
DI0	Turn ON.
DI1 to DI5	Turn OFF.
DI6	Turn ON.
DI7	This is the trigger signal to clear an error. After DI0 to DI6 are set, turn ON DI7 after an interval over 1 ms. After checking that the ERROR signal is OFF, turn DI7 OFF, and then turn DI0 to DI6 OFF.

Parallel Troubleshooting

Problem	Cause	Action
There is absolutely no data output.	You have selected more than three lines in Multi-line Random-trigger Mode.	Decrease the number of lines or use a communications method other than parallel communications.
	The [Output] setting is turned OFF.	Select [Layout setup] in the Window menu on the Main Window, and then turn ON the [Output] setting.
Even though there is more than one data output item, only the last data item is output.	The data is being overwritten because the ON status of the GATE signal is not being checked.	Read data only when the GATE signal is ON. Use handshaking for the output control to control the output timing.
STGOUT and SHTOUT are not being output.	You have selected a different signal in the system settings.	Select the correct signal for the application in the [Output signal selection] of the output signal settings in the system settings.
Measurement is not executed even when a STEP signal is input.	The STEP signal is chattering.	Check the contacts and input method used to prevent chattering. Set the STEP signal filter to a period longer than the input period that results in chattering.
STEP signals are input at random.	Unintended STEP signals are being input due to noise.	Perform noise prevention measures. Set the STEP signal filter to a period longer than the input period that results in chattering.
The READY signal is always OFF.	The image mode is set to Through Mode on the Main Window.	Change the image mode to [Freeze] or [Last NG].
	Camera Image Input HDR or Camera Image Input HDR Lite is being used in the current measurement flow.	When using Camera Image Input HDR or Camera Image Input HDR Lite, the READY signal will turn OFF for the number of Camera images taken.
	More than one Camera Image Input is being used in the current measurement flow.	If you execute more than one Camera Image Input in a single measurement flow, the READY signal will turn OFF for the number of Camera images taken.
There is a delay in the SHTOUT ON timing.	You are using more than one Camera in the current measurement flow.	When you use more than one Camera, the SHTOUT signal turns ON only after the slowest Camera exposure is completed.

Appendices

Command Control	350
-----------------------	-----

Command Control

This section describes the commands that are used to control the Sensor Controller from an external device.

Parameter Notation Examples for Command Control

This section provides examples of binary inputs of parameters and other arguments for command control.

Note

The storage order depends on the manufacturer of the connected PLC as follows:

- OMRON and Yaskawa Electric PLCs: Upper byte followed by lower byte
- Mitsubishi Electric PLCs: Lower byte followed by upper byte^{*1}

*1: The order of displayed sequence program may be from upper byte to low byte.
If it does not perform correctly, confirm the order of upper and low byte.

Four-byte Data

The following example shows the input to change the scene to scene number 5 with the Switch Scene command.

First word in Command Area	Description
+2 and +3 words	Command code (1000 0030 hex)
+4 and +5 words	Scenes number 5 (0000 0005 hex)

• OMRON or Yaskawa Electric PLCs

Command (PLC to Sensor Controller)

First word in Command Area	Hexadecimal notation	Bit				Description
		12 to 15	8 to 11	4 to 7	0 to 3	
+2	1000	0001	0000	0000	0000	Command code
+3	0030	0000	0000	0011	0000	
+4	0005	0000	0000	0000	0101	Scene No.
+5	0000	0000	0000	0000	0000	

• Mitsubishi Electric PLCs

Command (PLC to Sensor Controller)

First word in Command Area	Hexadecimal notation	Bit				Description
		12 to 15	8 to 11	4 to 7	0 to 3	
+2	1000	0001	0000	0000	0000	Command code
+3	0030	0000	0000	0011	0000	
+4	0500	0000	0101	0000	0000	Scene No.
+5	0000	0000	0000	0000	0000	

Specifying Character Strings

Specify the ASCII character code for every two bytes.

In this example, the inputs are given to save the image data for image data 1 to a destination specified by the absolute path (USBDisk\IMG01\LABEL.IFZ) with the Save Image command.

First word in Command Area	Description
+2 and +3 words	Command code (4000 0070 hex)
+4 and +5 words	Image data number 1 (0000 0001 hex)
+6 to +17 words	Save destination (USBDisk\IMG01\LABEL.IFZ)

• OMRON or Yaskawa Electric PLCs

Command (PLC to Sensor Controller)

First word in Command Area	Hexadecimal notation	Bit				Description
		12 to 15	8 to 11	4 to 7	0 to 3	
+2	4000	0100	0000	0000	0000	Command code
+3	0070	0000	0000	0111	0000	
+4	0001	0000	0000	0000	0001	Image data No.
+5	0000	0000	0000	0000	0000	
+6	5553	0101	0101	0101	0011	Destination +6: 5553(US) +7: 4244(BD) +8: 6973(is) +9: 6b32(k2) +10: 5c49(l) +11: 4d47(MG) +12: 3031(01) +13: 5c4c(L) +14: 4142(AB) +15: 454c(EL) +16: 2e49(.I) +17: 465a(FZ)
+7	4244	0100	0010	0100	0100	
+8	6973	0110	1001	0111	0011	
+9	6b32	0110	1011	0011	0010	
+10	5c49	0101	1100	0100	1001	
+11	4d47	0100	1101	0100	0111	
+12	3031	0011	0000	0011	0001	
+13	5c4c	0101	1100	0100	1100	
+14	4142	0100	0001	0100	0010	
+15	454c	0100	0101	0100	1100	
+16	2e49	0010	1110	0100	1001	
+17	465a	0100	0110	0101	1010	

• **Mitsubishi Electric Corporation PLCs**

Command (PLC to Sensor Controller)

First word in Command Area	Hexadecimal notation	Bit				Description
		12 to 15	8 to 11	4 to 7	0 to 3	
+2	4000	0100	0000	0000	0000	Command code
+3	0070	0000	0000	0111	0000	
+4	0100	0000	0001	0000	0000	Image data No.
+5	0000	0000	0000	0000	0000	
+6	5355	0101	0011	0101	0101	Destination +6: 5355(SU) +7: 4442(DB) +8: 7369(si) +9: 326b(2k) +10: 495c(l) +11: 474d(GM) +12: 3130(10) +13: 4c5c(L) +14: 4241(BA) +15: 4c45(LE) +16: 492e(l.) +17: 5a46(ZF)
+7	4442	0100	0100	0100	0010	
+8	7369	0111	0011	0110	1001	
+9	326b	0011	0011	0110	1011	
+10	495c	0100	1001	0101	1100	
+11	474d	0100	0111	0100	1101	
+12	3130	0011	0001	0011	0000	
+13	4c5c	0100	1100	0101	1100	
+14	4241	0100	0010	0100	0001	
+15	4c45	0100	1100	0100	0101	
+16	492e	0100	1001	0010	1110	
+17	5a46	0101	1010	0100	0110	

Specifying Real Numbers

Specify 1,000 times the actual value to specify a real number.

In this example, the inputs are given to set the lower limit (external reference number 137) of measurement coordinate X to 123.4 for the Search processing item that is registered to processing unit 1 for the Set Unit Data command.

First word in Command Area	Description
+2 and +3 words	Command code (1000 0050 hex)
+4 and +5 words	Unit number 1 (0000 0001 hex)
+6 and +7 words	External reference number 137 (0000 0089 hex)
+8 and +9 words	Lower limit of measurement coordinate X: 123.4 (x 1,000: 123400 = 0001 E208 hex)

- **OMRON or Yaskawa Electric PLCs**

Command (PLC to Sensor Controller)

First word in Command Area	Hexadecimal notation	Bit				Description
		12 to 15	8 to 11	4 to 7	0 to 3	
+2	1000	0001	0000	0000	0000	Command code
+3	0050	0000	0000	0101	0000	
+4	0001	0000	0000	0000	0001	Unit No.
+5	0000	0000	0000	0000	0000	
+6	0089	0000	0000	1000	1001	External reference number
+7	0000	0000	0000	0000	0000	
+8	E208	1110	0010	0000	1000	Lower limit value of measurement coordinate X
+9	0001	0000	0000	0000	0001	

- **Mitsubishi Electric PLCs**

Command (PLC to Sensor Controller)

First word in Command Area	Hexadecimal notation	Bit				Description
		12 to 15	8 to 11	4 to 7	0 to 3	
+2	1000	0001	0000	0000	0000	Command code
+3	0050	0000	0000	0101	0000	
+4	0100	0000	0001	0000	0000	Unit No.
+5	0000	0000	0000	0000	0000	
+6	8900	1000	1001	0000	0000	External reference number
+7	0000	0000	0000	0000	0000	
+8	08E2	0000	1000	1110	0010	Lower limit value of measurement coordinate X
+9	0100	0000	0001	0000	0000	

Details of Commands Used in EtherCAT Communication

Command codes and command parameters used in EtherCAT communication are specified as described below via the I/O port for commands generated for the FH.

- Command Code : Holds the command code to be executed.
- Command Parameter 0 to 3 : Holds the parameter of the command to be executed.

IMPORTANT

Command Parameter 3 cannot be used in the reserved area. Use Command Parameter 0 to 2.

Command details in the Appendix are described based on PLC memory addresses.

When specifying command codes and command parameters in EtherCAT communication, substitute command details as indicated below.

First word in Command Area	Command Code	Bit				
		15-12	11-8	7-4	3-0	
+2	0000	0000	0000	0000	0000	} Command Code 4 bytes
+3	0000	0000	0000	0000	0000	
+4	0000	0000	0000	0000	0000	} Command Parameter 0 4 bytes
+5	0000	0000	0000	0000	0000	
+6	0000	0000	0000	0000	0000	} Command Parameter 1 4 bytes
+7	0000	0000	0000	0000	0000	
+8	0000	0000	0000	0000	0000	} Command Parameter 2 4 bytes
+9	0000	0000	0000	0000	0000	
+10	0000	0000	0000	0000	0000	} Command Parameter 3 4 bytes
+11	0000	0000	0000	0000	0000	

Command List

This section lists the commands that you can use with the FH or FZ5 and the communications protocols for which each command is supported.

Note

In addition to the standard communications commands that are given here, you can also create custom commands and define the processing for them.

Creating custom commands is useful to expand the function of a standard command to create more advanced commands, and to otherwise combine multiple commands into one command to simplify controlling operation from a PLC or other external device.

Refer to ► *Custom Communications Commands* in the *Vision System FH/FZ5 Series User's Manual* (Cat. No. Z365).

Execution Commands

OK: Applicable command, RST: Command with restricted execution, NA: Non-applicable command

Function	Parallel Reference: ► (p.333)	PLC link Reference: ► (p.199)	EtherNet/IP Reference: ► (p.251)	EtherCAT Reference: ► (p.81)	Non-procedure Reference: ► (p.292)
Measurement is performed one time	NA ^{*1}	OK	NA ^{*1}	OK	OK
Starts continuous measurement	OK	OK	OK	OK	OK
Stops continuous measurement	NA	OK	OK	OK	OK
Executes measurement tests on specified units	NA	OK	OK	OK	OK
Clears measurement values	OK	OK	OK	OK	OK
Clears the data output buffer	NA	NA	NA	OK	NA
Saves in the Sensor Controller	NA	OK	OK	OK	OK
Re-registers the model data with the current image	NA	OK	OK	OK	OK
Moves the image display position in parallel the specified distance	NA	OK	OK	OK	OK
Zooms in/out the image display by the specified zoom ratio	NA	OK	OK	OK	OK
Returns the display position and display zoom ratio to their initial values	NA	OK	OK	OK	OK
Copies scene data	NA	OK	OK	OK	OK
Deletes scene data	NA	OK	OK	OK	OK
Moves scene data	NA	OK	OK	OK	OK
Registers specified image data as registered image	NA	OK	RST ^{*2}	NA	OK
Loads the specified registered data as a measurement image	NA	OK	OK	OK	OK
Responds in the response areas +5+6 with the data that was set in command areas +4+5	NA	OK	NA	NA	NA
Returns the input string as is to the output (echo)	NA	NA	OK	OK	OK
Executes the specified command string after a specified delay	NA	NA	NA	NA	OK
Adds a user account to a specified group ID	NA	OK	RST ^{*2}	NA	OK
Deletes a specified user account	NA	OK	RST ^{*2}	NA	OK
Branches to the start of the measurement flow (processing unit No. 0)	NA	OK	OK	OK	OK

OK: Applicable command, RST: Command with restricted execution, NA: Non-applicable command

Function	Parallel Reference: ▶ (p.333)	PLC link Reference: ▶ (p.199)	EtherNet/IP Reference: ▶ (p.251)	EtherCAT Reference: ▶ (p.81)	Non- procedure Reference: ▶ (p.292)
Restarts the Sensor Controller	NA	OK	OK	OK	OK
Clear Error	OK	NA	NA ^{*3}	NA ^{*3}	NA
Clear Parallel OR+DO	OK	NA	NA	NA	NA

*1: You can execute the same operation with the Measurement Execution Bit (STEP signal is allocated for both the parallel communications and EtherNet/IP) in the control signals.

*2: You cannot execute tag data link commands. Execute the command with message communications.

*3: You can execute the same operation with the Error Clear Bit (EtherNet/IP: ERCLR, EtherCAT: Error Clear) in the control signals.

Commands to Get Status

OK: Applicable command, RST: Command with restricted execution, NA: Non-applicable command

Function	Parallel	PLC link Reference: ▶ (p.199)	EtherNet/IP Reference: ▶ (p.252)	EtherCAT Reference: ▶ (p.82)	Non- procedure Reference: ▶ (p.292)
Acquires scene number	NA	OK	OK	OK	OK
Acquires scene group number	NA	OK	OK	OK	OK
Gets the currently displayed layout number.	NA	OK	OK	OK	OK
Gets the number of the unit currently displayed in the specified display image window.	NA	OK	OK	OK	OK
Gets the number of the sub-image in the specified image display window	NA	OK	OK	OK	OK
Gets the image mode for the specified image display window.	NA	OK	OK	OK	OK
Gets the input state of an individual communications module: Enabled or Disabled.	NA	OK	OK	OK	OK
Gets the output state to an external device: Enabled or Disabled.	NA	OK	OK	OK	OK
Gets the state of the specified parallel I/O terminal: Active or Inactive.	NA	OK	OK	OK	OK
Gets the ON/OFF states of all parallel terminals except for DI terminals.	NA	OK	OK	OK	OK
Gets the ON/OFF states of all parallel DI terminals.	NA	OK	OK	OK	OK
Gets the user name for the currently logged in user account.	NA	OK	RST* ¹	NA	OK
Gets the affiliation group ID for the currently logged in user account.	NA	OK	RST* ¹	NA	OK
Gets the operation log state	NA	OK	OK	OK	OK

*1: You cannot execute tag data link commands. Execute the command with message communications.

Commands to Set Status

OK: Applicable command, RST: Command with restricted execution, NA: Non-applicable command

Function	Parallel Reference: ▶ (p.333)	PLC link Reference: ▶ (p.200)	EtherNet/IP Reference: ▶ (p.252)	EtherCAT Reference: ▶ (p.82)	Non-procedure Reference: ▶ (p.293)
Switching Scenes	OK	OK	OK	OK	OK
Switches the scene group number	OK	OK	OK	OK	OK
Sets a layout number to switch between screens.	NA	OK	OK	OK	OK
Sets the number of the unit displayed in the specified image display window	NA	OK	OK	OK	OK
Sets the number of the sub-image displayed in the specified image display window	NA	OK	OK	OK	OK
Sets the image mode for the specified image display window.	NA	OK	OK	OK	OK
Enables/Disables inputs into an individual communications module.	NA	OK	OK	OK	OK
Enables/Disables outputs to external devices.	NA	OK	OK	OK	OK
Sets specified parallel I/O terminals ON/OFF	NA	OK	OK	OK	OK
Sets the ON/OFF states of all parallel terminals, except for DO terminals	NA	OK	OK	OK	OK
Sets the ON/OFF states of all parallel DO terminals	NA	OK	OK	OK	OK
Changes the user account used by the user currently logging in.	NA	OK	RST*1	NA	OK
Sets the operation log state	NA	OK	OK	OK	OK

*1: You cannot execute tag data link commands. Execute the command with message communications.

Commands to Read Data

OK: Applicable command, RST: Command with restricted execution, NA: Non-applicable command

Function	Parallel	PLC link Reference: ▶ (p.200)	EtherNet/IP Reference: ▶ (p.253)	EtherCAT Reference: ▶ (p.83)	Non- procedure Reference: ▶ (p.294)
Acquires unit data	NA	OK	OK	OK	OK
Gets the current date and time.	NA	OK	RST ^{*1}	NA	OK
Acquires system version information	NA	OK	RST ^{*1}	NA	OK
Acquires settings related to image logging.	NA	OK	RST ^{*1}	NA	OK
Gets the defined image logging folder name.	NA	OK	RST ^{*1}	NA	OK
Gets the defined data logging folder name.	NA	OK	RST ^{*1}	NA	OK
Gets the defined screen capture folder name.	NA	OK	RST ^{*1}	NA	OK
Acquires the set image logging prefix	NA	OK	RST ^{*1}	NA	OK
Acquires the set data logging condition	NA	OK	OK	OK	OK
Gets the parallel DI terminal offset data that is set.	NA	OK	OK	OK	OK

*1: You cannot execute tag data link commands. Execute the command with message communications.

Commands to Write Data

OK: Applicable command, RST: Command with restricted execution, NA: Non-applicable command

Function	Parallel	PLC link Reference: ▶ (p.201)	EtherNet/IP Reference: ▶ (p.253)	EtherCAT Reference: ▶ (p.83)	Non- procedure Reference: ▶ (p.294)
Sets unit data	NA	OK	OK	OK	OK
Sets the date/time.	NA	OK	RST ^{*1}	NA	OK
Changes settings related to image logging ^{*2}	NA	OK	RST ^{*1}	NA	OK
Sets the image logging folder name. ^{*2}	NA	OK	RST ^{*1}	NA	OK
Setting the data logging folder name. ^{*2}	NA	OK	RST ^{*1}	NA	OK
Setting the screen capture folder name ^{*2}	NA	OK	RST ^{*1}	NA	OK
Sets the image logging prefix.	NA	OK	RST ^{*1}	NA	OK
Sets the data logging condition. ^{*2}	NA	OK	OK	OK	OK
Sets the parallel DI terminal offset data.	NA	OK	OK	OK	OK

*1: You cannot execute tag data link commands. Execute the command with message communications.

*2: When you save data, the save destination differs depending on Sensor Controller model.

The save destination differ depending on the Sensor Controller type.

When you use FH series/FZ5-800 series/FZ5-1100 series/FZ5-1200 series, do not save to the any folder except RAMDisk and external memory device (such as C:\ProgramFiles\FZ). It is possible not to perform correctly due to the decrease of Scene data storage region.

Save destination	FH series/FZ5-800 series/FZ5-1100 series/FZ5-1200 series	FZ5-L series/FZ5-600 series
RAMDisk	C:\Data\RAMDisk	\RAMDISK
External memory	E:\, F:\, G:\, H:\, M:\ (FH series only)	\USBdisk to \USBdisk3

File Load Commands

The load destination differs depending on the Sensor Controller model.

Load destination	FH series/FZ5-800 series/FZ5-1100 series/FZ5-1200 series	FZ5-L series/FZ5-600 series
RAMDisk	C:\Data\RAMDisk	\RAMDISK
External memory	E:\, F:\, G:\, H:\, M:\ (FH series only)	\USBdisk to \USBdisk3

OK: Applicable command, RST: Command with restricted execution, NA: Non-applicable command

Function	Parallel	PLC link Reference: ► (p.201)	EtherNet/IP Reference: ► (p.253)	EtherCAT	Non-procedure Reference: ► (p.294)
Loads the Scene data	NA	OK	RST ^(*1)	NA	OK
Loads the scene group data	NA	OK	RST ^(*1)	NA	OK
Loads system data	NA	OK	RST ^(*1)	NA	OK
Loads System + Scene group 0 data	NA	OK	RST ^(*1)	NA	OK

*1: You cannot execute tag data link commands. Execute the command with message communications.

File Save Commands

The save destination to use differs by Sensor Controller model.

When you use FH series/FZ5-800 series/FZ5-1100 series/FZ5-1200 series, do not save to the any folder except RAMDisk and external memory device (such as C:\ProgramFiles\FZ). It is possible not to perform correctly due to the decrease of Scene data storage region.

Save destination	FH series/FZ5-800 series/FZ5-1100 series/FZ5-1200 series	FZ5-L series/FZ5-600 series
RAMDisk	C:\Data\RAMDisk	\RAMDISK
External memory	E:\, F:\, G:\, H:\, M:\ (FH series only)	\USBdisk to \USBdisk3

OK: Applicable command, RST: Command with restricted execution, NA: Non-applicable command

Function	Parallel	PLC link Reference: ► (p.201)	EtherNet/IP Reference: ► (p.254)	EtherCAT	Non-procedure Reference: ► (p.295)
Saves the Scene data	NA	OK	RST ^(*1)	NA	OK
Saves the scene group data	NA	OK	RST ^(*1)	NA	OK
Saves system data	NA	OK	RST ^(*1)	NA	OK
Saves the image data	NA	OK	RST ^(*1)	NA	OK
Saves all the image data in the image buffer (specified with [main unit logging image]).	NA	OK	RST ^(*1)	NA	OK
Saves the last logging image	NA	OK	RST ^(*1)	NA	OK
Saves System + Scene Group 0 data in a file	NA	OK	RST ^(*1)	NA	OK
Captures a screen	NA	OK	RST ^(*1)	NA	OK

*1: You cannot execute tag data link commands. Execute the command with message communications.

Command Details for PLC Link, EtherNet/IP, and EtherCAT

This section provides details on the communications commands.

Executing Measurement

Executes measurement one time.

Command (PLC to Sensor Controller)

First word in Command Area	Command code	Bit				Description
		12 to 15	8 to 11	4 to 7	0 to 3	
+2	1010	0001	0000	0001	0000	Command code
+3	0010	0000	0000	0001	0000	

Response (Sensor Controller to PLC)

First word in Response Area	Command code	Bit				Description
		12 to 15	8 to 11	4 to 7	0 to 3	
+2	1010	0001	0000	0001	0000	Command code
+3	0010	0000	0000	0001	0000	Response target command codes
+4	-	0000	0000	0000	0000	Response code
+5	-	0000	0000	0000	0000	Command execution result OK: 0(0000 0000) NG: Not 0 (0000 0000)

Starting Continuous Measurement

Starts continuous measurement.

Command (PLC to Sensor Controller)

First word in Command Area	Command code	Bit				Description
		12 to 15	8 to 11	4 to 7	0 to 3	
+2	1020	0001	0000	0010	0000	Command code
+3	0010	0000	0000	0001	0000	

Response (Sensor Controller to PLC)

First word in Response Area	Command code	Bit				Description
		12 to 15	8 to 11	4 to 7	0 to 3	
+2	1020	0001	0000	0010	0000	Command code
+3	0010	0000	0000	0001	0000	Response target command codes
+4	-	0000	0000	0000	0000	Response code
+5	-	0000	0000	0000	0000	Command execution result OK: 0(0000 0000) NG: Not 0 (0000 0000)

Stopping Continuous Measurement

Stops continuous measurement.

Command (PLC to Sensor Controller)

First word in Command Area	Command code	Bit				Description
		12 to 15	8 to 11	4 to 7	0 to 3	
+2	1030	0001	0000	0011	0000	Command code
+3	0010	0000	0000	0001	0000	

Response (Sensor Controller to PLC)

First word in Response Area	Command code	Bit				Description
		12 to 15	8 to 11	4 to 7	0 to 3	
+2	1030	0001	0000	0011	0000	Command code
+3	0010	0000	0000	0001	0000	Response target command codes
+4	-	0000	0000	0000	0000	Response code
+5	-	0000	0000	0000	0000	Command execution result OK: 0(0000 0000) NG: Not 0 (0000 0000)

Unit Stand-alone Test Measurement Execution

Performs a test measurement on the specified unit.

Command (PLC to Sensor Controller)

First word in Command Area	Command code	Bit				Description
		12 to 15	8 to 11	4 to 7	0 to 3	
+2	1040	0001	0000	0100	0000	Command code
+3	0010	0000	0000	0001	0000	
+4	-	0000	0000	0000	0000	Unit No.
+5	-	0000	0000	0000	0000	

IMPORTANT

You cannot use the Unit Stand-alone Test Measurement Execution command for the following Camera Image Input processing units.

- Camera Image Input, Camera Image Input GigE, Camera Image Input FH,
- Camera Image Input HDR, and Camera Image Input HDR Lite

Response (Sensor Controller to PLC)

First word in Response Area	Command code	Bit				Description
		12 to 15	8 to 11	4 to 7	0 to 3	
+2	1040	0001	0000	0100	0000	Command code Response target command codes
+3	0010	0000	0000	0001	0000	
+4	-	0000	0000	0000	0000	Response code Command execution result OK: 0(0000 0000) NG: Not 0 (0000 0000)
+5	-	0000	0000	0000	0000	

Clearing Measurement Values

Clears all measurement values.

Command (PLC to Sensor Controller)

First word in Command Area	Command code	Bit				Description
		12 to 15	8 to 11	4 to 7	0 to 3	
+2	2010	0010	0000	0001	0000	Command code
+3	0010	0000	0000	0001	0000	

Response (Sensor Controller to PLC)

First word in Response Area	Command code	Bit				Description
		12 to 15	8 to 11	4 to 7	0 to 3	
+2	2010	0010	0000	0001	0000	Command code Response target command codes
+3	0010	0000	0000	0001	0000	
+4	-	0000	0000	0000	0000	Response code Command execution result OK: 0(0000 0000) NG: Not 0 (0000 0000)
+5	-	0000	0000	0000	0000	

Clear Data Output Buffer

Clears the data output buffer.

Command (PLC to Sensor Controller)

First word in Command Area	Command code	Bit				Description
		12 to 15	8 to 11	4 to 7	0 to 3	
+2	2020	0010	0000	0010	0000	Command code
+3	0010	0000	0000	0001	0000	

Response (Sensor Controller to PLC)

First word in Response Area	Command code	Bit				Description
		12 to 15	8 to 11	4 to 7	0 to 3	
+2	2020	0010	0000	0010	0000	Command code Response target command codes
+3	0010	0000	0000	0001	0000	
+4	-	0000	0000	0000	0000	Response code Command execution result OK: 0(0000 0000) NG: Not 0 (0000 0000)
+5	-	0000	0000	0000	0000	

Saving in Sensor Controller

Stores the current system data and scene group data in the Sensor Controller.

Command (PLC to Sensor Controller)

First word in Command Area	Command code	Bit				Description
		12 to 15	8 to 11	4 to 7	0 to 3	
+2	3010	0011	0000	0001	0000	Command code
+3	0010	0000	0000	0001	0000	

Response (Sensor Controller to PLC)

First word in Response Area	Command code	Bit				Description
		12 to 15	8 to 11	4 to 7	0 to 3	
+2	3010	0011	0000	0001	0000	Command code Response target command codes
+3	0010	0000	0000	0001	0000	
+4	-	0000	0000	0000	0000	Response code Command execution result OK: 0(0000 0000) NG: Not 0 (0000 0000)
+5	-	0000	0000	0000	0000	

Model Re-registration

Reregisters a model using the current model.

Command (PLC to Sensor Controller)

First word in Command Area	Command code	Bit				Description
		12 to 15	8 to 11	4 to 7	0 to 3	
+2	4010	0100	0000	0001	0000	Command code
+3	0010	0000	0000	0001	0000	
+4	-	0000	0000	0000	0000	Unit No.
+5	-	0000	0000	0000	0000	
+6	-	0000	0000	0000	0000	Model No.
+7	-	0000	0000	0000	0000	
+8	-	0000	0000	0000	0000	Specifies the target data.
+9	-	0000	0000	0000	0000	<p>When the setting value is expressed in binary, if bit 0 of the first word in the Command Area + 8 is 1, the model is reregistered.</p> <p>When the setting value is expressed in binary, if the bit 1 is 1, the reference position is updated.</p> <p>When the setting value is expressed in binary, if the bit 2 is 1, the detection position is updated.</p> <p>Example)</p> <p>011: To reregister/update the model and reference position</p> <p>101: To reregister/update the model and detection point</p> <p>111: To reregister/update everything</p>

Response (Sensor Controller to PLC)

First word in Response Area	Command code	Bit				Description
		12 to 15	8 to 11	4 to 7	0 to 3	
+2	4010	0100	0000	0001	0000	Command code
+3	0010	0000	0000	0001	0000	Response target command codes
+4	-	0000	0000	0000	0000	Response code
+5	-	0000	0000	0000	0000	<p>Command execution result</p> <p>OK: 0(0000 0000)</p> <p>NG: Not 0 (0000 0000)</p>

Scroll

The image display window whose number is specified is moved the specified distance in parallel. The setting range for the movement distance is not restricted. Also, because the scale for movement is independent of the display zoom ratio, the movement is not affected by change in the zoom ratio.

Command (PLC to Sensor Controller)

First word in Command Area	Command code	Bit				Description
		12 to 15	8 to 11	4 to 7	0 to 3	
+2	5010	0101	0000	0001	0000	Command code
+3	0010	0000	0000	0001	0000	
+4	-	0000	0000	0000	0000	Display image window number
+5	-	0000	0000	0000	0000	
+6	-	0000	0000	0000	0000	X movement distance (camera coordinate system)
+7	-	0000	0000	0000	0000	
+8	-	0000	0000	0000	0000	Y movement distance (camera coordinate system)
+9	-	0000	0000	0000	0000	

Response (Sensor Controller to PLC)

First word in Response Area	Command code	Bit				Description
		12 to 15	8 to 11	4 to 7	0 to 3	
+2	5010	0101	0000	0001	0000	Command code
+3	0010	0000	0000	0001	0000	Response target command codes
+4	-	0000	0000	0000	0000	Response code
+5	-	0000	0000	0000	0000	Command execution result OK: 0(0000 0000) NG: Not 0 (0000 0000)

Zoom

Zooms the image display window whose number is specified in or out to the specified zoom ratio. The zoom ratio here is the ratio compared to the original image (100%).

Command (PLC to Sensor Controller)

First word in Command Area	Command code	Bit				Description
		12 to 15	8 to 11	4 to 7	0 to 3	
+2	5020	0101	0000	0010	0000	Command code
+3	0010	0000	0000	0001	0000	
+4	-	0000	0000	0000	0000	Display image window number
+5	-	0000	0000	0000	0000	
+6	-	0000	0000	0000	0000	Sets magnification. (Value multiplied by 1000) Example)
+7	-	0000	0000	0000	0000	25%: Enter 250 (0.25 × 1,000) 1,600%: Enter 16000 (16 × 1,000)

Response (Sensor Controller to PLC)

First word in Response Area	Command code	Bit				Description
		12 to 15	8 to 11	4 to 7	0 to 3	
+2	5020	0101	0000	0010	0000	Command code
+3	0010	0000	0000	0001	0000	Response target command codes
+4	-	0000	0000	0000	0000	Response code
+5	-	0000	0000	0000	0000	Command execution result OK: 0(0000 0000) NG: Not 0 (0000 0000)

Fit

Returns the display position and display zoom ratio for the image display window to their default values.

Command (PLC to Sensor Controller)

First word in Command Area	Command code	Bit				Description
		12 to 15	8 to 11	4 to 7	0 to 3	
+2	5030	0101	0000	0011	0000	Command code
+3	0010	0000	0000	0001	0000	
+4	-	0000	0000	0000	0000	Image display window number (0 to 23)
+5	-	0000	0000	0000	0000	

Response (Sensor Controller to PLC)

First word in Response Area	Command code	Bit				Description
		12 to 15	8 to 11	4 to 7	0 to 3	
+2	5030	0101	0000	0011	0000	Command code
+3	0010	0000	0000	0001	0000	Response target command codes
+4	-	0000	0000	0000	0000	Response code
+5	-	0000	0000	0000	0000	Command execution result OK: 0(0000 0000) NG: Not 0 (0000 0000)

Scene Data Copy

Copies the data for the scene with the number specified with command argument 1 to the scene with the number specified with command argument 2. If there is already data at the copy destination, the copied data is written over that data.

Command (PLC to Sensor Controller)

First word in Command Area	Command code	Bit				Description
		12 to 15	8 to 11	4 to 7	0 to 3	
+2	7010	0111	0000	0001	0000	Command code
+3	0010	0000	0000	0001	0000	
+4	-	0000	0000	0000	0000	Copy source scene No.
+5	-	0000	0000	0000	0000	
+6	-	0000	0000	0000	0000	Copy destination scene No.
+7	-	0000	0000	0000	0000	

Response (Sensor Controller to PLC)

First word in Response Area	Command code	Bit				Description
		12 to 15	8 to 11	4 to 7	0 to 3	
+2	7010	0111	0000	0001	0000	Command code
+3	0010	0000	0000	0001	0000	Response target command codes
+4	-	0000	0000	0000	0000	Response code
+5	-	0000	0000	0000	0000	Command execution result OK: 0(0000 0000) NG: Not 0 (0000 0000)

Scene Data Deletion

Deletes the data for the scene whose number is specified with command argument 1.

Command (PLC to Sensor Controller)

First word in Command Area	Command code	Bit				Description
		12 to 15	8 to 11	4 to 7	0 to 3	
+2	7020	0111	0000	0010	0000	Command code
+3	0010	0000	0000	0001	0000	
+4	-	0000	0000	0000	0000	Number of the scene to delete
+5	-	0000	0000	0000	0000	

Response (Sensor Controller to PLC)

First word in Response Area	Command code	Bit				Description
		12 to 15	8 to 11	4 to 7	0 to 3	
+2	7020	0111	0000	0010	0000	Command code
+3	0010	0000	0000	0001	0000	Response target command codes
+4	-	0000	0000	0000	0000	Response code
+5	-	0000	0000	0000	0000	Command execution result OK: 0(0000 0000) NG: Not 0 (0000 0000)

Scene Data Move

Copies the data for the scene with the number specified with command argument 1 to the scene with the number specified with command argument 2. Deletes scene data with a number specified by command argument 1 after completing copying. If there is already data at the copy destination, the copied data is written over that data.

Command (PLC to Sensor Controller)

First word in Command Area	Command code	Bit				Description
		12 to 15	8 to 11	4 to 7	0 to 3	
+2	7030	0111	0000	0011	0000	Command code
+3	0010	0000	0000	0001	0000	
+4	-	0000	0000	0000	0000	Source scene number
+5	-	0000	0000	0000	0000	
+6	-	0000	0000	0000	0000	Target scene number
+7	-	0000	0000	0000	0000	

Response (Sensor Controller to PLC)

First word in Response Area	Command code	Bit				Description
		12 to 15	8 to 11	4 to 7	0 to 3	
+2	7030	0111	0000	0011	0000	Command code
+3	0010	0000	0000	0001	0000	Response target command codes
+4	-	0000	0000	0000	0000	Response code
+5	-	0000	0000	0000	0000	Command execution result OK: 0(0000 0000) NG: Not 0 (0000 0000)

Registered Image Setting

Registers the specified image data as a registered image. After the command is executed, the status will be the same as when the image was registered with the Registered Image Manager. If the source is the last measured image (0), command argument 3 (logged image number or file name) can be omitted.

Command (PLC to Sensor Controller)

First word in Command Area	Command code	Bit				Description
		12 to 15	8 to 11	4 to 7	0 to 3	
+2	8010	1000	0000	0001	0000	Command code
+3	0010	0000	0000	0001	0000	
+4	-	0000	0000	0000	0000	Any data (0 to 999)
+5	-	0000	0000	0000	0000	
+6	-	0000	0000	0000	0000	Data type of source 0: Last measured image 1: Logged image 2: Image file
+7	-	0000	0000	0000	0000	
+8	-	0000	0000	0000	0000	Logged image number or file name If the source is a logged image, specify the logging file number. (0 to Number of logged images in Controller – 1)
+9	-	0000	0000	0000	0000	
:	-	0000	0000	0000	0000	If the source is an image file, specify the image file name (0 to 256 characters).

Response (Sensor Controller to PLC)

First word in Response Area	Command code	Bit				Description
		12 to 15	8 to 11	4 to 7	0 to 3	
+2	8010	1000	0000	0001	0000	Command code
+3	0010	0000	0000	0001	0000	Response target command code
+4	-	0000	0000	0000	0000	Response code Command execution result OK: 0(0000 0000) NG: Not 0 (0000 0000)
+5	-	0000	0000	0000	0000	

Loading Registration Images

Loads a specified registered image as a measurement image. After the command is executed, the status will be the same as when the image was loaded with the Registered Image Manager.

Command (PLC to Sensor Controller)

First word in Command Area	Command code	Bit				Description
		12 to 15	8 to 11	4 to 7	0 to 3	
+2	8020	1000	0000	0010	0000	Command code
+3	0010	0000	0000	0001	0000	
+4	-	0000	0000	0000	0000	Registered image number (0 to 999)
+5	-	0000	0000	0000	0000	

Response (Sensor Controller to PLC)

First word in Response Area	Command code	Bit				Description
		12 to 15	8 to 11	4 to 7	0 to 3	
+2	8020	1000	0000	0010	0000	Command code
+3	0010	0000	0000	0001	0000	Response target command code
+4	-	0000	0000	0000	0000	Response code
+5	-	0000	0000	0000	0000	Command execution result OK: 0(0000 0000) NG: Not 0 (0000 0000)

Echo

Returns as is any character string sent by an external device. Command argument 1 is alphanumeric only. Responds in the response areas +6+7 with the data that was set in command areas +4+5.

Command (PLC to Sensor Controller)

First word in Command Area	Command code	Bit				Description
		12 to 15	8 to 11	4 to 7	0 to 3	
+2	9010	1001	0000	0001	0000	Command code
+3	0010	0000	0000	0001	0000	
+4	-	0000	0000	0000	0000	Any data (2 words)
+5	-	0000	0000	0000	0000	

Response (Sensor Controller to PLC)

First word in Response Area	Command code	Bit				Description
		12 to 15	8 to 11	4 to 7	0 to 3	
+2	9010	1001	0000	0001	0000	Command code
+3	0010	0000	0000	0001	0000	Response target command codes
+4	-	0000	0000	0000	0000	Response code
+5	-	0000	0000	0000	0000	Command execution result OK: 0(0000 0000) NG: Not 0 (0000 0000)
+6	-	0000	0000	0000	0000	Response data
+7	-	0000	0000	0000	0000	Any data (2 words)

User Account Setting

Adds a user account to the specified group ID. If the group ID the account of the user currently logging in belongs is not 0, a command error occurs. If the user account to be set has already existed, it will be overwritten with the new account.

Command (PLC to Sensor Controller)

First word in Command Area	Command code	Bit				Description
		12 to 15	8 to 11	4 to 7	0 to 3	
+2	A010	1010	0000	0001	0000	Command code
+3	0010	0000	0000	0001	0000	
+4	-	0000	0000	0000	0000	ID of group to which to add the user account 0 to 7
+5	-	0000	0000	0000	0000	
+6	-	0000	0000	0000	0000	User name of user account to add Single-byte alphanumeric characters: 2 to 20 characters
:	-	0000	0000	0000	0000	
+21	-	0000	0000	0000	0000	
+22	-	0000	0000	0000	0000	Password of user account to add
:	-	0000	0000	0000	0000	
+37	-	0000	0000	0000	0000	
+38	-	0000	0000	0000	0000	User name of user account (UG0) that has the right to add user accounts
:	-	0000	0000	0000	0000	
+53	-	0000	0000	0000	0000	
+54	-	0000	0000	0000	0000	Password (UG0)
:	-	0000	0000	0000	0000	
+70	-	0000	0000	0000	0000	

Response (Sensor Controller to PLC)

First word in Response Area	Command code	Bit				Description
		12 to 15	8 to 11	4 to 7	0 to 3	
+2	A010	1010	0000	0001	0000	Command code
+3	0010	0000	0000	0001	0000	Response target command codes
+4	-	0000	0000	0000	0000	Response code
+5	-	0000	0000	0000	0000	Command execution result OK: 0(0000 0000) NG: Not 0 (0000 0000)

User Account Deletion

Deletes the specified user account. If the group ID the account of the user currently logging in belongs to is not 0, a command error occurs. If the specified user account does not exist, a command acknowledge returns.

Command (PLC to Sensor Controller)

First word in Command Area	Command code	Bit				Description
		12 to 15	8 to 11	4 to 7	0 to 3	
+2	A020	1010	0000	0010	0000	Command code
+3	0010	0000	0000	0001	0000	
+4	-	0000	0000	0000	0000	User name of user account to delete
:	-	0000	0000	0000	0000	
+19	-	0000	0000	0000	0000	
+20	-	0000	0000	0000	0000	User name of user account (UG0) that has the right to delete user accounts
:	-	0000	0000	0000	0000	
+35	-	0000	0000	0000	0000	
+36	-	0000	0000	0000	0000	Password (UG0)
:	-	0000	0000	0000	0000	
+52	-	0000	0000	0000	0000	

Response (Sensor Controller to PLC)

First word in Response Area	Command code	Bit				Description
		12 to 15	8 to 11	4 to 7	0 to 3	
+2	A020	1010	0000	0010	0000	Command code
+3	0010	0000	0000	0001	0000	Response target command codes
+4	-	0000	0000	0000	0000	Response code
+5	-	0000	0000	0000	0000	Command execution result OK: 0(0000 0000) NG: Not 0 (0000 0000)

Return to a Flow Head

Branches to the flow head (processing unit No. 0). Only supports execution of commands in the flow.

Command (PLC to Sensor Controller)

First word in Command Area	Command code	Bit				Description
		12 to 15	8 to 11	4 to 7	0 to 3	
+2	B010	1011	0000	0001	0000	Command code
+3	0010	0000	0000	0001	0000	

Response (Sensor Controller to PLC)

First word in Response Area	Command code	Bit				Description
		12 to 15	8 to 11	4 to 7	0 to 3	
+2	B010	1011	0000	0001	0000	Command code Response target command codes
+3	0010	0000	0000	0001	0000	
+4	-	0000	0000	0000	0000	Response code Command execution result OK: 0(0000 0000) NG: Not 0 (0000 0000)
+5	-	0000	0000	0000	0000	

Restart

Restarts the Sensor Controller.

IMPORTANT

- When a restart command is executed, BUSY does not turn off even after the command execution bit turns off. After a restart command is executed, perform a memory clear of BUSY on the PLC side.

Command (PLC to Sensor Controller)

First word in Command Area	Command code	Bit				Description
		12 to 15	8 to 11	4 to 7	0 to 3	
+2	F010	1111	0000	0001	0000	Command code
+3	0010	0010	0000	0001	0000	

Response (Sensor Controller to PLC)

There is no response because restarting is performed.

Acquiring Scene Number

Acquires the current scene No.

Command (PLC to Sensor Controller)

First word in Command Area	Command code	Bit				Description
		12 to 15	8 to 11	4 to 7	0 to 3	
+2	1000	0001	0000	0000	0000	Command code
+3	0020	0000	0000	0010	0000	

Response (Sensor Controller to PLC)

First word in Response Area	Command code	Bit				Description
		12 to 15	8 to 11	4 to 7	0 to 3	
+2	1000	0001	0000	0000	0000	Command code
+3	0020	0000	0000	0010	0000	Response target command codes
+4	-	0000	0000	0000	0000	Response code
+5	-	0000	0000	0000	0000	Command execution result OK: 0(0000 0000) NG: Not 0 (0000 0000)
+6	-	0000	0000	0000	0000	Response data
+7	-	0000	0000	0000	0000	Acquired scene No.

Acquiring Scene Group Number

Acquires the current scene group No.

Command (PLC to Sensor Controller)

First word in Command Area	Command code	Bit				Description
		12 to 15	8 to 11	4 to 7	0 to 3	
+2	2000	0010	0000	0000	0000	Command code
+3	0020	0000	0000	0010	0000	

Response (Sensor Controller to PLC)

First word in Response Area	Command code	Bit				Description
		12 to 15	8 to 11	4 to 7	0 to 3	
+2	2000	0010	0000	0000	0000	Command code
+3	0020	0000	0000	0010	0000	Response target command codes
+4	-	0000	0000	0000	0000	Response code
+5	-	0000	0000	0000	0000	Command execution result OK: 0(0000 0000) NG: Not 0 (0000 0000)
+6	-	0000	0000	0000	0000	Response data
+7	-	0000	0000	0000	0000	Acquired scene group No.

Getting Layout Number

Gets the number of the currently displayed layout.

Command (PLC to Sensor Controller)

First word in Command Area	Command code	Bit				Description
		12 to 15	8 to 11	4 to 7	0 to 3	
+2	4000	0100	0000	0000	0000	Command code
+3	0020	0000	0000	0010	0000	
+4	-	0000	0000	0000	0000	Item to acquire 0: Local 1: Remote
+5	-	0000	0000	0000	0000	

IMPORTANT

- For non-remote operation, only 0: Local can be specified. For remote operation, only 1: Remote can be specified. If any combination other than the above combinations is used, unexpected operation may occur when the command is executed.

Response (Sensor Controller to PLC)

First word in Response Area	Command code	Bit				Description
		12 to 15	8 to 11	4 to 7	0 to 3	
+2	4000	0100	0000	0000	0000	Command code
+3	0020	0000	0000	0010	0000	Response target command codes
+4	-	0000	0000	0000	0000	Response code
+5	-	0000	0000	0000	0000	Command execution result OK: 0(0000 0000) NG: Not 0 (0000 0000)
+6	-	0000	0000	0000	0000	Response data
+7	-	0000	0000	0000	0000	Current layout number (0 to 8)

Getting Display Image Unit Number

Gets the number of the unit currently displayed in the specified image display window.

Command (PLC to Sensor Controller)

First word in Command Area	Command code	Bit				Description
		12 to 15	8 to 11	4 to 7	0 to 3	
+2	5010	0101	0000	0001	0000	Command code
+3	0020	0000	0000	0010	0000	
+4	-	0000	0000	0000	0000	Image display window number FH: Image display window number (0 to 23) FZ5: Displaying 1 image: 1 Displaying 2 images: 1 and 2 Displaying 4 images: 1 to 4 Displaying thumbnails: 0 to 4
+5	-	0000	0000	0000	0000	

Response (Sensor Controller to PLC)

First word in Response Area	Command code	Bit				Description
		12 to 15	8 to 11	4 to 7	0 to 3	
+2	5010	0101	0000	0001	0000	Command code
+3	0020	0000	0000	0010	0000	Response target command codes
+4	-	0000	0000	0000	0000	Response code
+5	-	0000	0000	0000	0000	Command execution result OK: 0(0000 0000) NG: Not 0 (0000 0000)
+6	-	0000	0000	0000	0000	Response data
+7	-	0000	0000	0000	0000	Unit No.

Getting Display Sub-image Number

Gets the number of the sub-image currently displayed in the specified image display window.

Command (PLC to Sensor Controller)

First word in Command Area	Command code	Bit				Description
		12 to 15	8 to 11	4 to 7	0 to 3	
+2	5020	0101	0000	0010	0000	Command code
+3	0020	0000	0000	0010	0000	
+4	-	0000	0000	0000	0000	Image display window number (0 to 23)
+5	-	0000	0000	0000	0000	

Response (Sensor Controller to PLC)

First word in Response Area	Command code	Bit				Description
		12 to 15	8 to 11	4 to 7	0 to 3	
+2	5020	0101	0000	0010	0000	Command code
+3	0020	0000	0000	0010	0000	Response target command codes
+4	-	0000	0000	0000	0000	Response code
+5	-	0000	0000	0000	0000	Command execution result OK: 0(0000 0000) NG: Not 0 (0000 0000)
+6	-	0000	0000	0000	0000	Response data
+7	-	0000	0000	0000	0000	Sub image number

Getting Image Display State

Gets the image mode for the specified image display window.

Command (PLC to Sensor Controller)

First word in Command Area	Command code	Bit				Description
		12 to 15	8 to 11	4 to 7	0 to 3	
+2	5030	0101	0000	0011	0000	Command code
+3	0020	0000	0000	0010	0000	
+4	-	0000	0000	0000	0000	Image display window number (0 to 23)
+5	-	0000	0000	0000	0000	

Response (Sensor Controller to PLC)

First word in Response Area	Command code	Bit				Description
		12 to 15	8 to 11	4 to 7	0 to 3	
+2	5030	0101	0000	0011	0000	Command code
+3	0020	0000	0000	0010	0000	Response target command codes
+4	-	0000	0000	0000	0000	Response code
+5	-	0000	0000	0000	0000	Command execution result OK: 0(0000 0000) NG: Not 0 (0000 0000)
+6	-	0000	0000	0000	0000	Response data
+7	-	0000	0000	0000	0000	Image mode 0: Through 1: Freeze or Freeze and Last NG together 2: Last NG

Getting Communication Input State

Gets the input state (permitted/prohibited) for communication modules.

Command (PLC to Sensor Controller)

First word in Command Area	Command code	Bit				Description
		12 to 15	8 to 11	4 to 7	0 to 3	
+2	7010	0111	0000	0001	0000	Command code
+3	0020	0000	0000	0010	0000	
+4	-	0000	0000	0000	0000	Communication module types
+5	-	0000	0000	0000	0000	0: Serial (Ethernet) 1: Serial (RS-232C/422) 2: Parallel I/O 3: Fieldbus 4: Remote operation

Response (Sensor Controller to PLC)

First word in Response Area	Command code	Bit				Description
		12 to 15	8 to 11	4 to 7	0 to 3	
+2	7010	0111	0000	0001	0000	Command code
+3	0020	0000	0000	0010	0000	Response target command codes
+4	-	0000	0000	0000	0000	Response code
+5	-	0000	0000	0000	0000	Command execution result OK: 0(0000 0000) NG: Not 0 (0000 0000)
+6	-	0000	0000	0000	0000	Response data
+7	-	0000	0000	0000	0000	Input state 0: Prohibited 1: Permitted

Getting Communication Output State

Gets the output state to an external device: Enabled or Disabled:

Command (PLC to Sensor Controller)

First word in Command Area	Command code	Bit				Description
		12 to 15	8 to 11	4 to 7	0 to 3	
+2	7020	0111	0000	0010	0000	Command code
+3	0020	0000	0000	0010	0000	

Response (Sensor Controller to PLC)

First word in Response Area	Command code	Bit				Description
		12 to 15	8 to 11	4 to 7	0 to 3	
+2	7020	0111	0000	0010	0000	Command code
+3	0020	0000	0000	0010	0000	Response target command codes
+4	-	0000	0000	0000	0000	Response code
+5	-	0000	0000	0000	0000	Command execution result OK: 0(0000 0000) NG: Not 0 (0000 0000)
+6	-	0000	0000	0000	0000	Response data
+7	-	0000	0000	0000	0000	Output state 0: Prohibited 1: Permitted

Get Parallel Terminal Status

Gets the state of the specified parallel I/O terminal: Active or Inactive.

For how to set, refer to the following:

Example)

When you want to acquire the terminal status of STEP0 in Line 0.

1. Select 0 in the Terminal type. STEP is set.
2. Select 0 in the Terminal number, STEP0 of Line0.
3. Sends the specified settings of the above step 1 and 2 to the specified port number of Line0.
4. The specified Terminal status will be responded.

Command (PLC to Sensor Controller)

First word in Command Area	Command code	Bit				Description
		12 to 15	8 to 11	4 to 7	0 to 3	
+2	8010	1000	0000	0001	0000	Command code
+3	0020	0000	0000	0010	0000	
+4	-	0000	0000	0000	0000	Terminal type:
+5	-	0000	0000	0000	0000	Set the terminal by combining Terminal number. Specified terminal differ according to the Sensor Controller series. For detail, refer to *1.
+6	-	0000	0000	0000	0000	Terminal number:
+7	-	0000	0000	0000	0000	Set the terminal by combining Terminal type. Specified terminal differ according to the Sensor Controller series. For detail, refer to *1.

Response (Sensor Controller to PLC)

First word in Response Area	Command code	Bit				Description
		12 to 15	8 to 11	4 to 7	0 to 3	
+2	8010	1000	0000	0001	0000	Command code
+3	0020	0000	0000	0010	0000	Response target command codes
+4	-	0000	0000	0000	0000	Response code
+5	-	0000	0000	0000	0000	Command execution result OK: 0(0000 0000) NG: Not 0 (0000 0000)
+6	-	0000	0000	0000	0000	Response data
+7	-	0000	0000	0000	0000	Terminal state 0: OFF 1: ON

*1: Terminal type and Terminal number
FH-1000 series/FH-3000 series Sensor Controller

Terminal type		Terminal number							
		0	1	2	3	4	5	6	7
STEP	0	STEP0	STEP1	STEP2	STEP3	STEP4	STEP5	STEP6	STEP7
DSA	1	DSA0	DSA1	-	-	-	-	-	-
DI	2	DI0	DI1	DI2	DI3	DI4	DI5	DI6	DI7
DI_LINE	11	DILINE0	DILINE1	DILINE2	-	-	-	-	-

Terminal type		Terminal number							
		0	1	2	3	4	5	6	7
STEP	0	STEP0	STEP1	-	-	-	-	-	-
DSA	1	DSA0	DSA1	-	-	-	-	-	-
DI	2	DI0	DI1	DI2	DI3	DI4	DI5	DI6	DI7
DI_LINE	11	-	-	-	-	-	-	-	-

Terminal type		Terminal number							
		0	1	2	3	4	5	6	7
STEP	0	STEP0	-	-	-	-	-	-	-
DSA	1	DSA0	-	-	-	-	-	-	-
DI	2	DI0	DI1	DI2	DI3	DI4	DI5	DI6	DI7
DI_LINE	11	-	-	-	-	-	-	-	-

IMPORTANT

- When the Multi-line Random Trigger mode is selected in the following series, usable signal type or assignment are differ depending on the used number of Lines.
 - FH-1000 series
 - FH-3000 series
 - FZ5-800 series
 - FZ5-1100 series
 - FZ5-1200 series
- For more details of Operation mode, refer to ► Multi-line Random Trigger Mode Signal Specifications (p.325).
- This command gets the terminal status of each line by specifying its port number.
When getting the terminal status of an unusable line, the response code will be OK and the response data will always be 0.
Verify the received data by changing the actual parallel terminal status.

Get All Parallel Terminal Statuses

Gets the ON/OFF status of all parallel terminals except for DI terminals

For how to set, refer to the following:

Example)

When you want to acquire the terminal status except DI terminal of Line 0.

1. Send a command to get the all of the terminal status to the specified port number of Line0.
2. All of the Parallel terminal status except DI are responded.

Command (PLC to Sensor Controller)

First word in Command Area	Command code	Bit				Description
		12 to 15	8 to 11	4 to 7	0 to 3	
+2	8020	1000	0000	0010	0000	Command code
+3	0020	0000	0000	0010	0000	

Response (Sensor Controller to PLC)

First word in Response Area	Command code	Bit				Description
		12 to 15	8 to 11	4 to 7	0 to 3	
+2	8020	1000	0000	0010	0000	Command code
+3	0020	0000	0000	0010	0000	Response target command codes
+4	-	0000	0000	0000	0000	Response code
+5	-	0000	0000	0000	0000	Command execution result OK: 0(0000 0000) NG: Not 0 (0000 0000)
+6	-	0000	0000	0000	0000	Response data
+7	-	0000	0000	0000	0000	Parallel terminal status except DI (0: OFF / 1: ON) Parallel terminal except DI can be assigned to the BIT of Response data. This assignment differs by the Sensor Controller series or by line in use. For more details, refer to *1.

*1: Response data
FH-1000 series/FH-3000 series Sensor Controller

Supported bit	Terminal							
	Line 0	Line 1	Line 2	Line 3	Line 4	Line 5	Line 6	Line 7
BIT0	STEP0	STEP1	STEP2	STEP3	STEP4	STEP5	STEP6	STEP7
BIT1	DSA0	DSA1	0	0	0	0	0	0
BIT2	DILINE0	DILINE0	DILINE0	DILINE0	DILINE0	DILINE0	DILINE0	DILINE0
BIT3	DILINE1	DILINE1	DILINE1	DILINE1	DILINE1	DILINE1	DILINE1	DILINE1
BIT4	DILINE2	DILINE2	DILINE2	DILINE2	DILINE2	DILINE2	DILINE2	DILINE2
BIT5	0	0	0	0	0	0	0	0
BIT6	0	0	0	0	0	0	0	0
BIT7	0	0	0	0	0	0	0	0
BIT8	0	0	0	0	0	0	0	0
BIT9	0	0	0	0	0	0	0	0
BIT10	0	0	0	0	0	0	0	0
BIT11	0	0	0	0	0	0	0	0
BIT12	0	0	0	0	0	0	0	0
BIT13	0	0	0	0	0	0	0	0
BIT14	0	0	0	0	0	0	0	0
BIT15	0	0	0	0	0	0	0	0

FH-L series Sensor Controller

Supported bit	Terminal
	Line 0
BIT0	STEP0
BIT1	DSA0
BIT2	0
BIT3	0
BIT4	0
BIT5	0
BIT6	0
BIT7	0
BIT8	0
BIT9	0
BIT10	0
BIT11	0
BIT12	0
BIT13	0
BIT14	0
BIT15	0

FZ5-800/FZ5-1100/FZ5-1200 series Sensor Controller

Supported bit	Terminal	
	Line 0	Line 1
BIT0	STEP0	STEP0
BIT1	STEP1	STEP1
BIT2	DSA0	DSA0
BIT3	DSA1	DSA1
BIT4	0	0
BIT5	0	0
BIT6	0	0
BIT7	0	0
BIT8	0	0
BIT9	0	0
BIT10	0	0
BIT11	0	0
BIT12	0	0
BIT13	0	0
BIT14	0	0
BIT15	0	0

Supported bit	Terminal
	Line 0
BIT0	STEP0
BIT1	0
BIT2	DSA0
BIT3	0
BIT4	0
BIT5	0
BIT6	0
BIT7	0
BIT8	0
BIT9	0
BIT10	0
BIT11	0
BIT12	0
BIT13	0
BIT14	0
BIT15	0

IMPORTANT

- When the Multi-line Random Trigger mode is selected in the following series, usable signal type or assignment are differ depending on the used number of Lines.
 - FH-1000 series
 - FH-3000 series
 - FZ5-800 series
 - FZ5-1100 series
 - FZ5-1200 series

For more details of Operation mode, refer to ► Multi-line Random Trigger Mode Signal Specifications (p.325).

- This command gets the terminal status of each line by specifying its port number.
When getting the terminal status of an unusable line, the response code will be OK and the response data will always be 0.

Verify the received data by changing the actual parallel terminal status.

Get All Parallel DI Terminal Statuses

Gets the ON/OFF states of all parallel DI terminals at once.

For how to set, refer to the following:

Example)

When you want to acquire the Parallel DI terminal status of Line 0.

1. Send a command to get the Parallel DI terminal at once to the specified port number of Line0.
2. All of the Parallel terminal status are responded.

Command (PLC to Sensor Controller)

First word in Command Area	Command code	Bit				Description
		12 to 15	8 to 11	4 to 7	0 to 3	
+2	8030	1000	0000	0011	0000	Command code
+3	0020	0000	0000	0010	0000	

Response (Sensor Controller to PLC)

First word in Response Area	Command code	Bit				Description
		12 to 15	8 to 11	4 to 7	0 to 3	
+2	8030	1000	0000	0011	0000	Command code
+3	0020	0000	0000	0010	0000	Response target command codes
+4	-	0000	0000	0000	0000	Response code
+5	-	0000	0000	0000	0000	Command execution result OK: 0(0000 0000) NG: Not 0 (0000 0000)
+6	-	0000	0000	0000	0000	Response data
+7	-	0000	0000	0000	0000	Parallel DI terminal status (0: OFF / 1: ON) Parallel DI terminal can be assigned to the BIT of Response data. This assignment differs by the Sensor Controller series or by line in use. For more details, refer to *1.

*1: Response data
FH-1000 series/FH-3000 series Sensor Controller

Supported bit	Terminal							
	Line 0	Line 1	Line 2	Line 3	Line 4	Line 5	Line 6	Line 7
BIT0	DI0	DI0	DI0	DI0	DI0	DI0	DI0	DI0
BIT1	DI1	DI1	DI1	DI1	DI1	DI1	DI1	DI1
BIT2	DI2	DI2	DI2	DI2	DI2	DI2	DI2	DI2
BIT3	DI3	DI3	DI3	DI3	DI3	DI3	DI3	DI3
BIT4	DI4	DI4	DI4	DI4	DI4	DI4	DI4	DI4
BIT5	DI5	DI5	DI5	DI5	DI5	DI5	DI5	DI5
BIT6	DI6	DI6	DI6	DI6	DI6	DI6	DI6	DI6
BIT7	DI7	DI7	DI7	DI7	DI7	DI7	DI7	DI7
BIT8	0	0	0	0	0	0	0	0
BIT9	0	0	0	0	0	0	0	0
BIT10	0	0	0	0	0	0	0	0
BIT11	0	0	0	0	0	0	0	0
BIT12	0	0	0	0	0	0	0	0
BIT13	0	0	0	0	0	0	0	0
BIT14	0	0	0	0	0	0	0	0
BIT15	0	0	0	0	0	0	0	0

FZ5-800/FZ5-1100/FZ5-1200 series Sensor Controller

Supported bit	Terminal	
	Line 0	Line 1
BIT0	DI0	DI0
BIT1	DI1	DI1
BIT2	DI2	DI2
BIT3	DI3	DI3
BIT4	DI4	DI4
BIT5	DI5	DI5
BIT6	DI6	DI6
BIT7	DI7	DI7
BIT8	0	0
BIT9	0	0
BIT10	0	0
BIT11	0	0
BIT12	0	0
BIT13	0	0
BIT14	0	0
BIT15	0	0

Supported bit	Terminal
	Line 0
BIT0	DI0
BIT1	DI1
BIT2	DI2
BIT3	DI3
BIT4	DI4
BIT5	DI5
BIT6	DI6
BIT7	DI7
BIT8	0
BIT9	0
BIT10	0
BIT11	0
BIT12	0
BIT13	0
BIT14	0
BIT15	0

IMPORTANT

This command gets the terminal status of each line by specifying its port number.
When getting the terminal status of an unusable line, the response code will be OK and the response data will always be 0.
Verify the received data by changing the actual parallel terminal status.

Acquires the Login Account Name

Acquiring the user name for the currently logged in account.

Command (PLC to Sensor Controller)

First word in Command Area	Command code	Bit				Description
		12 to 15	8 to 11	4 to 7	0 to 3	
+2	9000	1001	0000	0000	0000	Command code
+3	0020	0000	0000	0010	0000	
+4	-	0000	0000	0000	0000	Item to acquire 0: Local 1: Remote
+5	-	0000	0000	0000	0000	

Response (Sensor Controller to PLC)

First word in Response Area	Command code	Bit				Description
		12 to 15	8 to 11	4 to 7	0 to 3	
+2	9000	1001	0000	0000	0000	Command code
+3	0020	0000	0000	0010	0000	Response target command codes
+4	-	0000	0000	0000	0000	Response code Command execution result OK: 0(0000 0000) NG: Not 0 (0000 0000)
+5	-	0000	0000	0000	0000	
+6	-	0000	0000	0000	0000	Response data
+7	-	0000	0000	0000	0000	Acquired user name

Acquiring the Login Account Group ID

Acquires the group ID for the currently logged in account.

Command (PLC to Sensor Controller)

First word in Command Area	Command code	Bit				Description
		12 to 15	8 to 11	4 to 7	0 to 3	
+2	9010	1001	0000	0001	0000	Command code
+3	0020	0000	0000	0010	0000	
+4	-	0000	0000	0000	0000	Item to acquire 0: Local 1: Remote
+5	-	0000	0000	0000	0000	

Response (Sensor Controller to PLC)

First word in Response Area	Command code	Bit				Description
		12 to 15	8 to 11	4 to 7	0 to 3	
+2	9010	1001	0000	0001	0000	Command code
+3	0020	0000	0000	0010	0000	Response target command codes
+4	-	0000	0000	0000	0000	Response code
+5	-	0000	0000	0000	0000	Command execution result OK: 0(0000 0000) NG: Not 0 (0000 0000)
+6	-	0000	0000	0000	0000	Response data
+7	-	0000	0000	0000	0000	Acquired affiliated group ID

Getting Operation Log State

Gets the logging operation state.

Command (PLC to Sensor Controller)

First word in Command Area	Command code	Bit				Description
		12 to 15	8 to 11	4 to 7	0 to 3	
+2	A000	1010	0000	0000	0000	Command code
+3	0020	0000	0000	0010	0000	

Response (Sensor Controller to PLC)

First word in Response Area	Command code	Bit				Description
		12 to 15	8 to 11	4 to 7	0 to 3	
+2	A000	1010	0000	0000	0000	Command code
+3	0020	0000	0000	0010	0000	Response target command codes
+4	-	0000	0000	0000	0000	Response code
+5	-	0000	0000	0000	0000	Command execution result OK: 0(0000 0000) NG: Not 0 (0000 0000)
+6	-	0000	0000	0000	0000	Response data
+7	-	0000	0000	0000	0000	Operation log state gotten 0: OFF 1: ON

Scene Switching

Switches the scene to be used.

Command (PLC to Sensor Controller)

First word in Command Area	Command code	Bit				Description
		12 to 15	8 to 11	4 to 7	0 to 3	
+2	1000	0001	0000	0000	0000	Command code
+3	0030	0000	0000	0011	0000	
+4	-	0000	0000	0000	0000	Scene No.
+5	-	0000	0000	0000	0000	

Response (Sensor Controller to PLC)

First word in Response Area	Command code	Bit				Description
		12 to 15	8 to 11	4 to 7	0 to 3	
+2	1000	0001	0000	0000	0000	Command code
+3	0030	0000	0000	0011	0000	Response target command codes
+4	-	0000	0000	0000	0000	Response code
+5	-	0000	0000	0000	0000	Command execution result OK: 0(0000 0000) NG: Not 0 (0000 0000)

Scene Group Switching

Switches the scene group to be used.

Command (PLC to Sensor Controller)

First word in Command Area	Command code	Bit				Description
		12 to 15	8 to 11	4 to 7	0 to 3	
+2	2000	0010	0000	0000	0000	Command code
+3	0030	0000	0000	0011	0000	
+4	-	0000	0000	0000	0000	Scene group No.
+5	-	0000	0000	0000	0000	

Response (Sensor Controller to PLC)

First word in Response Area	Command code	Bit				Description
		12 to 15	8 to 11	4 to 7	0 to 3	
+2	2000	0010	0000	0000	0000	Command code
+3	0030	0000	0000	0011	0000	Response target command codes
+4	-	0000	0000	0000	0000	Response code
+5	-	0000	0000	0000	0000	Command execution result OK: 0(0000 0000) NG: Not 0 (0000 0000)

Set Layout Number

Sets the layout number and switches the window.

Command (PLC to Sensor Controller)

First word in Command Area	Command code	Bit				Description
		12 to 15	8 to 11	4 to 7	0 to 3	
+2	4000	0100	0000	0000	0000	Command code
+3	0030	0000	0000	0011	0000	
+4	-	0000	0000	0000	0000	Settable Objects 0: Local 1: Remote
+5	-	0000	0000	0000	0000	
+6	-	0000	0000	0000	0000	Layout number 0: Layout 0 1: Layout 1 2: Layout 2 3: Layout 3 4: Layout 4 5: Layout 5 6: Layout 6 7: Layout 7 8: Layout 8
+7	-	0000	0000	0000	0000	

IMPORTANT

- For non-remote operation, only 0: Local can be specified. For remote operation, only 1: Remote can be specified. If any combination other than the above combinations is used, unexpected operation may occur when the command is executed.

Response (Sensor Controller to PLC)

First word in Response Area	Command code	Bit				Description
		12 to 15	8 to 11	4 to 7	0 to 3	
+2	4000	0100	0000	0000	0000	Command code
+3	0030	0000	0000	0011	0000	Response target command codes
+4	-	0000	0000	0000	0000	Response code
+5	-	0000	0000	0000	0000	Command execution result OK: 0(0000 0000) NG: Not 0 (0000 0000)

Display Image Unit Number Setting

Sets the number of the unit displayed in the specified image display window.

Command (PLC to Sensor Controller)

First word in Command Area	Command code	Bit				Description
		12 to 15	8 to 11	4 to 7	0 to 3	
+2	5010	0101	0000	0001	0000	Command code
+3	0030	0000	0000	0011	0000	
+4	-	0000	0000	0000	0000	Image display window number (0 to 23)
+5	-	0000	0000	0000	0000	
+6	-	0000	0000	0000	0000	Unit number (-1 to unit number of current scene - 1) If you specify -1, [Define displayed unit] is set.
+7	-	0000	0000	0000	0000	

Response (Sensor Controller to PLC)

First word in Response Area	Command code	Bit				Description
		12 to 15	8 to 11	4 to 7	0 to 3	
+2	5010	0101	0000	0001	0000	Command code
+3	0030	0000	0000	0011	0000	Response target command codes
+4	-	0000	0000	0000	0000	Response code
+5	-	0000	0000	0000	0000	Command execution result OK: 0(0000 0000) NG: Not 0 (0000 0000)

Display Image Sub-numbers Setting

Sets the number of the sub-image displayed in the specified image display window.

Command (PLC to Sensor Controller)

First word in Command Area	Command code	Bit				Description
		12 to 15	8 to 11	4 to 7	0 to 3	
+2	5020	0101	0000	0010	0000	Command code
+3	0030	0000	0000	0011	0000	
+4	-	0000	0000	0000	0000	Image display window number (0 to 23)
+5	-	0000	0000	0000	0000	
+6	-	0000	0000	0000	0000	Sub image number.
+7	-	0000	0000	0000	0000	

Response (Sensor Controller to PLC)

First word in Response Area	Command code	Bit				Description
		12 to 15	8 to 11	4 to 7	0 to 3	
+2	5020	0101	0000	0010	0000	Command code
+3	0030	0000	0000	0011	0000	Response target command codes
+4	-	0000	0000	0000	0000	Response code
+5	-	0000	0000	0000	0000	Command execution result OK: 0(0000 0000) NG: Not 0 (0000 0000)

Image Display State Setting

Sets the image mode for the specified image display window.

Command (PLC to Sensor Controller)

First word in Command Area	Command code	Bit				Description
		12 to 15	8 to 11	4 to 7	0 to 3	
+2	5030	0101	0000	0011	0000	Command code
+3	0030	0000	0000	0011	0000	
+4	-	0000	0000	0000	0000	Image display window number (0 to 23)
+5	-	0000	0000	0000	0000	
+6	-	0000	0000	0000	0000	Image mode 0: Through 1: Freeze or Freeze and Last NG together 2: Last NG
+7	-	0000	0000	0000	0000	

Response (Sensor Controller to PLC)

First word in Response Area	Command code	Bit				Description
		12 to 15	8 to 11	4 to 7	0 to 3	
+2	5030	0101	0000	0011	0000	Command code
+3	0030	0000	0000	0011	0000	Response target command codes
+4	-	0000	0000	0000	0000	Response code
+5	-	0000	0000	0000	0000	Command execution result OK: 0(0000 0000) NG: Not 0 (0000 0000)

Communication Input State Setting

Permits/prohibits input to communication modules. Any communication module whose input state is set to Prohibit (0) accepts no communications whatsoever. However, inputs related to hardware (parallel STEP signals/DSA signals and ECAT STEP, etc.) are not included in the prohibition.

Command (PLC to Sensor Controller)

First word in Command Area	Command code	Bit				Description
		12 to 15	8 to 11	4 to 7	0 to 3	
+2	7010	0111	0000	0001	0000	Command code
+3	0030	0000	0000	0011	0000	
+4	-	0000	0000	0000	0000	Communication module types 0: Serial (Ethernet) 1: Serial (RS-232C/422) 2: Parallel IO 3: Fieldbus 4: Remote operation
+5	-	0000	0000	0000	0000	
+6	-	0000	0000	0000	0000	Input state 0: Prohibited 1: Permitted
+7	-	0000	0000	0000	0000	

Response (Sensor Controller to PLC)

First word in Response Area	Command code	Bit				Description
		12 to 15	8 to 11	4 to 7	0 to 3	
+2	7010	0111	0000	0001	0000	Command code
+3	0030	0000	0000	0011	0000	Response target command codes
+4	-	0000	0000	0000	0000	Response code Command execution result OK: 0(0000 0000) NG: Not 0 (0000 0000)
+5	-	0000	0000	0000	0000	

Communication Output State Setting

Permits/prohibits output to external devices. When the input state is disabled, i.e., set to (0), all the communications modules are unable to transmit data.

Command (PLC to Sensor Controller)

First word in Command Area	Command code	Bit				Description
		12 to 15	8 to 11	4 to 7	0 to 3	
+2	7020	0111	0000	0010	0000	Command code
+3	0030	0000	0000	0011	0000	
+4	-	0000	0000	0000	0000	Output state 0: Prohibited 1: Permitted
+5	-	0000	0000	0000	0000	

Response (Sensor Controller to PLC)

First word in Response Area	Command code	Bit				Description
		12 to 15	8 to 11	4 to 7	0 to 3	
+2	7020	0111	0000	0010	0000	Command code
+3	0030	0000	0000	0011	0000	Response target command codes
+4	-	0000	0000	0000	0000	Response code
+5	-	0000	0000	0000	0000	Command execution result OK: 0(0000 0000) NG: Not 0 (0000 0000)

Set Parallel Terminal Status

Sets the specified parallel I/O terminal: ON/OFF

Specifies the Parallel terminal with a combination of terminal type, terminal number and terminal status.

For how to set, refer to the following:

Example)

When you want to set the OR3 of Line3 status.

1. Set [6] in terminal type, [OR] is specified.
2. Set [3] in terminal number, [OR3] is specified.
3. Set [1] in terminal status, [OR3] terminal is specified to turn ON from OFF.
4. Send the specified command which set the above step 1 to 3 to the port number of Line 3.
5. Executed result of command is responded.

Command (PLC to Sensor Controller)

First word in Command Area	Command code	Bit				Description
		12 to 15	8 to 11	4 to 7	0 to 3	
+2	8010	1000	0000	0001	0000	Command code
+3	0030	0000	0000	0011	0000	
+4	-	0000	0000	0000	0000	Terminal type:
+5	-	0000	0000	0000	0000	Set the terminal by combining Terminal number. Specified terminal differ according to the Sensor Controller series. For detail, refer to *1.
+6	-	0000	0000	0000	0000	Terminal number:
+7	-	0000	0000	0000	0000	Set the terminal by combining Terminal type. Specified terminal differ according to the Sensor Controller series. For detail, refer to *1.
+8	-	0000	0000	0000	0000	Terminal status:
+9	-	0000	0000	0000	0000	Set the specified terminal status. (0: OFF/1: ON)

Response (Sensor Controller to PLC)

First word in Response Area	Command code	Bit				Description
		12 to 15	8 to 11	4 to 7	0 to 3	
+2	8010	1000	0000	0001	0000	Command code Response target command codes
+3	0030	0000	0000	0011	0000	
+4	-	0000	0000	0000	0000	Response code Command execution result OK: 0(0000 0000) NG: Not 0 (0000 0000)
+5	-	0000	0000	0000	0000	

*1: Terminal type and terminal number
FH-1000 series/FH-3000 series Sensor Controller

Terminal type		Terminal number															
		0	1	2	3	4	5	6	7	8	9	10	11	12	13	14	15
RUN	3	RUN0	RUN1	RUN2	RUN3	-	-	-	-	-	-	-	-	-	-	-	-
ERR	4	ERROR/ ERROR0	ERROR1	ERROR2	ERROR3	-	-	-	-	-	-	-	-	-	-	-	-
BUSY	5	BUSY0	BUSY1	BUSY2	BUSY3	BUSY4	BUSY5	BUSY6	BUSY7	-	-	-	-	-	-	-	-
OR	6	OR0	OR1	OR2	OR3	OR4	OR5	OR6	OR7	-	-	-	-	-	-	-	-
GATE	7	GATE0	GATE1	-	-	-	-	-	-	-	-	-	-	-	-	-	-
READY	8	READY0	READY1	READY2	READY3	READY4	READY5	READY6	READY7	-	-	-	-	-	-	-	-
DO	9	DO0	DO1	DO2	DO3	DO4	DO5	DO6	DO7	DO8	DO9	DO10	DO11	DO12	DO13	DO14	DO15
ACK	10	ACK	-	-	-	-	-	-	-	-	-	-	-	-	-	-	-

FZ5-800/FZ5-1100/FZ5-1200 series Sensor Controller

Terminal type		Terminal number															
		0	1	2	3	4	5	6	7	8	9	10	11	12	13	14	15
RUN	3	RUN/ BUSY1	-	-	-	-	-	-	-	-	-	-	-	-	-	-	-
ERR	4	ERROR	-	-	-	-	-	-	-	-	-	-	-	-	-	-	-
BUSY	5	BUSY0	-	-	-	-	-	-	-	-	-	-	-	-	-	-	-
OR	6	OR0	OR1	-	-	-	-	-	-	-	-	-	-	-	-	-	-
GATE	7	GATE0	GATE1	-	-	-	-	-	-	-	-	-	-	-	-	-	-
READY	8	READY0	READY1	-	-	-	-	-	-	-	-	-	-	-	-	-	-
DO	9	DO0	DO1	DO2	DO3	DO4	DO5	DO6	DO7	DO8	DO9	DO10	DO11	DO12	DO13	DO14	DO15
ACK	10	-	-	-	-	-	-	-	-	-	-	-	-	-	-	-	-

Terminal type	Terminal number																
	0	1	2	3	4	5	6	7	8	9	10	11	12	13	14	15	
RUN	3	RUN	-	-	-	-	-	-	-	-	-	-	-	-	-	-	
ERR	4	ERROR	-	-	-	-	-	-	-	-	-	-	-	-	-	-	
BUSY	5	BUSY0	-	-	-	-	-	-	-	-	-	-	-	-	-	-	
OR	6	OR0	-	-	-	-	-	-	-	-	-	-	-	-	-	-	
GATE	7	GATE0	-	-	-	-	-	-	-	-	-	-	-	-	-	-	
READY	8	READY0	-	-	-	-	-	-	-	-	-	-	-	-	-	-	
DO	9	DO0	DO1	DO2	DO3	DO4	DO5	DO6	DO7	DO8	DO9	DO10	DO11	DO12	DO13	DO14	DO15
ACK	10	-	-	-	-	-	-	-	-	-	-	-	-	-	-	-	-

IMPORTANT

- When the Multi-line Random Trigger mode is selected in the following series, usable signal type or assignment are differ depending on the used number of Lines.
 - FH-1000 series
 - FH-3000 series
 - FZ5-800 series
 - FZ5-1100 series
 - FZ5-1200 series
- For more details of Operation mode, refer to ► Multi-line Random Trigger Mode Signal Specifications (p.325).
- Sending the commands to the port number assigned to each Lines, the terminal status of each lines can be require. When required the unusable terminal status, response cord is OK and the response data is discarded. Make sure to check the acquired data by actually changing the parallel terminal status.

Set All Parallel Terminal Statuses

Sets the ON/OFF status of all parallel terminals, except for DO terminals.

For how to set, refer to the following:

Example)

When you want to set the Parallel terminal status, except DO of Line 0, to ON at once:

- Set the terminal status ON to the desired assignment BIT of Parallel terminal except DO.
- Send the specified command which set step 1 to the port number of Line 0.
- Executed result of command is responded.

Command (PLC to Sensor Controller)

First word in Command Area	Command code	Bit				Description
		12 to 15	8 to 11	4 to 7	0 to 3	
+2	8020	1000	0000	0010	0000	Command code
+3	0030	0000	0000	0011	0000	
+4	-	0000	0000	0000	0000	Terminal status: Set the terminal status (0: OFF/1: ON) to the assigned terminal of each BIT. For detail of assigned terminal, refer to *1.
+5	-	0000	0000	0000	0000	

Response (Sensor Controller to PLC)

First word in Response Area	Command code	Bit				Description
		12 to 15	8 to 11	4 to 7	0 to 3	
+2	8020	1000	0000	0010	0000	Command code
+3	0030	0000	0000	0011	0000	Response target command codes
+4	-	0000	0000	0000	0000	Response code
+5	-	0000	0000	0000	0000	Command execution result OK: 0(0000 0000) NG: Not 0 (0000 0000)

*1: Assigned terminal to each bit
FH-1000 series/FH-3000 series Sensor Controller

Supported bit	Terminal							
	Line 0	Line 1	Line 2	Line 3	Line 4	Line 5	Line 6	Line 7
BIT0	RUN0	RUN1	RUN2	RUN3	-	-	-	-
BIT1	ERROR/ ERROR0	ERROR1	ERROR2	ERROR3	ERROR	ERROR	ERROR	ERROR
BIT2	BUSY0	BUSY1	BUSY2	BUSY3	BUSY4	BUSY5	BUSY6	BUSY7
BIT3	OR0	OR1	OR2	OR3	OR4	OR5	OR6	OR7
BIT4	GATE0	GATE1	-	-	-	-	-	-
BIT5	READY0	READY1	READY2	READY3	READY4	READY5	READY6	READY7
BIT6	ACK	ACK	ACK	ACK	ACK	ACK	ACK	ACK
BIT7	-	-	-	-	-	-	-	-
BIT8	-	-	-	-	-	-	-	-
BIT9	-	-	-	-	-	-	-	-
BIT10	-	-	-	-	-	-	-	-
BIT11	-	-	-	-	-	-	-	-
BIT12	-	-	-	-	-	-	-	-
BIT13	-	-	-	-	-	-	-	-
BIT14	-	-	-	-	-	-	-	-
BIT15	-	-	-	-	-	-	-	-

FH-L series Sensor Controller

Supported bit	Terminal
	Line 0
BIT0	RUN
BIT1	ERROR
BIT2	BUSY
BIT3	OR0
BIT4	GATE0
BIT5	READY0
BIT6	ACK
BIT7	-
BIT8	-
BIT9	-
BIT10	-
BIT11	-
BIT12	-
BIT13	-
BIT14	-
BIT15	-

FZ5-800/FZ5-1100/FZ5-1200 series Sensor Controller

Supported bit	Terminal	
	Line 0	Line 1
BIT0	RUN	BUSY1
BIT1	ERROR	ERROR
BIT2	BUSY	BUSY0
BIT3	OR0	OR0
BIT4	OR1	OR1
BIT5	GATE0	GATE0
BIT6	GATE1	GATE1
BIT7	READY0	READY0
BIT8	READY1	READY1
BIT9	-	-
BIT10	-	-
BIT11	-	-
BIT12	-	-
BIT13	-	-
BIT14	-	-
BIT15	-	-

Supported bit	Terminal
	Line 0
BIT0	RUN
BIT1	ERROR
BIT2	BUSY
BIT3	OR0
BIT4	-
BIT5	GATE0
BIT6	-
BIT7	READY0
BIT8	-
BIT9	-
BIT10	-
BIT11	-
BIT12	-
BIT13	-
BIT14	-
BIT15	-

IMPORTANT

- When the Multi-line Random Trigger mode is selected in the following series, usable signal type or assignment are differ depending on the used number of Lines.
 - FH-1000 series
 - FH-3000 series
 - FZ5-800 series
 - FZ5-1100 series
 - FZ5-1200 series

For more details of Operation mode, refer to ► Multi-line Random Trigger Mode Signal Specifications (p.325).

- Sending the commands to the port number assigned to each Lines, the terminal status of each lines can be require. When required the unusable terminal status, response cord is OK and the response data is discarded. Make sure to check the acquired data by actually changing the parallel terminal status.

Set All Parallel DO Terminal Statuses

Sets the ON/OFF status of all Parallel DO terminals at once.

For how to set, refer to the following:

Example)

When you want to set the Parallel DO terminals status of Line 0, to ON at once:

1. Set the terminals status ON to the desired assignment BIT of the Parallel DO terminal status.
2. Send the specified command which set step 1 to the port number of Line 0.
3. Executed result of command is responded.

Command (PLC to Sensor Controller)

First word in Command Area	Command code	Bit				Description
		12 to 15	8 to 11	4 to 7	0 to 3	
+2	8030	1000	0000	0011	0000	Command code
+3	0030	0000	0000	0011	0000	
+4	-	0000	0000	0000	0000	Terminal state Parallel terminal status (0: OFF / 1: ON) is assigned to BIT of Terminal state. This assignment differ according the Sensor Controller series or used Lines. For more details, refer to *1.
+5	-	0000	0000	0000	0000	

Response (Sensor Controller to PLC)

First word in Response Area	Command code	Bit				Description
		12 to 15	8 to 11	4 to 7	0 to 3	
+2	8030	1000	0000	0011	0000	Command code
+3	0030	0000	0000	0011	0000	Response target command codes
+4	-	0000	0000	0000	0000	Response code
+5	-	0000	0000	0000	0000	Command execution result OK: 0(0000 0000) NG: Not 0 (0000 0000)

*1: Assigned terminal to each bit
 FH-1000 series/FH-3000 series Sensor Controller

Supported bit	Terminal							
	Line 0	Line 1	Line 2	Line 3	Line 4	Line 5	Line 6	Line 7
BIT0	DO0	DO0	DO0	DO0	DO0	DO0	DO0	DO0
BIT1	DO1	DO1	DO1	DO1	DO1	DO1	DO1	DO1
BIT2	DO2	DO2	DO2	DO2	DO2	DO2	DO2	DO2
BIT3	DO3	DO3	DO3	DO3	DO3	DO3	DO3	DO3
BIT4	DO4	DO4	DO4	DO4	DO4	DO4	DO4	DO4
BIT5	DO5	DO5	DO5	DO5	DO5	DO5	DO5	DO5
BIT6	DO6	DO6	DO6	DO6	DO6	DO6	DO6	DO6
BIT7	DO7	DO7	DO7	DO7	DO7	DO7	DO7	DO7
BIT8	DO8	DO8	DO8	DO8	DO8	DO8	DO8	DO8
BIT9	DO9	DO9	DO9	DO9	DO9	DO9	DO9	DO9
BIT10	DO10	DO10	DO10	DO10	DO10	DO10	DO10	DO10
BIT11	DO11	DO11	DO11	DO11	DO11	DO11	DO11	DO11
BIT12	DO12	DO12	DO12	DO12	DO12	DO12	DO12	DO12
BIT13	DO13	DO13	DO13	DO13	DO13	DO13	DO13	DO13
BIT14	DO14	DO14	DO14	DO14	DO14	DO14	DO14	DO14
BIT15	DO15	DO15	DO15	DO15	DO15	DO15	DO15	DO15

FZ5-800/FZ5-1100/FZ5-1200 series Sensor Controller

Supported bit	Terminal	
	Line 0	Line 1
BIT0	DO0	DO0
BIT1	DO1	DO1
BIT2	DO2	DO2
BIT3	DO3	DO3
BIT4	DO4	DO4
BIT5	DO5	DO5
BIT6	DO6	DO6
BIT7	DO7	DO7
BIT8	DO8	DO8
BIT9	DO9	DO9
BIT10	DO10	DO10
BIT11	DO11	DO11
BIT12	DO12	DO12
BIT13	DO13	DO13
BIT14	DO14	DO14
BIT15	DO15	DO15

Supported bit	Terminal
	Line 0
BIT0	DO0
BIT1	DO1
BIT2	DO2
BIT3	DO3
BIT4	DO4
BIT5	DO5
BIT6	DO6
BIT7	DO7
BIT8	DO8
BIT9	DO9
BIT10	DO10
BIT11	DO11
BIT12	DO12
BIT13	DO13
BIT14	DO14
BIT15	DO15

IMPORTANT

Sending the commands to the port number assigned to each Lines, the terminal status of each lines can be require. When required the unusable terminal status, response cord is OK and the response data is discarded. Make sure to check the acquired data by actually changing the parallel terminal status.

Login Account Setting

Switches the currently logged in account.

Command (PLC to Sensor Controller)

First word in Command Area	Command code	Bit				Description
		12 to 15	8 to 11	4 to 7	0 to 3	
+2	9000	1001	0000	0000	0000	Command code
+3	0030	0000	0000	0011	0000	
+4	-	0000	0000	0000	0000	Settable Objects 0: Local 1: Remote
+5	-	0000	0000	0000	0000	
+6	-	0000	0000	0000	0000	User name of user account
:	:	:	:	:	:	
+13	-	0000	0000	0000	0000	
+14	-	0000	0000	0000	0000	Password
:	:	:	:	:	:	
+21	-	0000	0000	0000	0000	

Response (Sensor Controller to PLC)

First word in Response Area	Command code	Bit				Description
		12 to 15	8 to 11	4 to 7	0 to 3	
+2	9000	1001	0000	0000	0000	Command code Response target command codes
+3	0030	0000	0000	0011	0000	
+4	-	0000	0000	0000	0000	Response code Command execution result OK: 0(0000 0000) NG: Not 0 (0000 0000)
+5	-	0000	0000	0000	0000	

Operation Log State Setting

Sets the logged operation state. This command allows configuring the logging operation state in the same manner as for the Start/End Logging Operation buttons on the Main screen.

Command (PLC to Sensor Controller)

First word in Command Area	Command code	Bit				Description
		12 to 15	8 to 11	4 to 7	0 to 3	
+2	A000	1010	0000	0000	0000	Command code
+3	0030	0000	0000	0011	0000	
+4	-	0000	0000	0000	0000	Logging operation state 0: OFF 1: ON
+5	-	0000	0000	0000	0000	

Response (Sensor Controller to PLC)

First word in Response Area	Command code	Bit				Description
		12 to 15	8 to 11	4 to 7	0 to 3	
+2	A000	1010	0000	0000	0000	Command code Response target command codes
+3	0030	0000	0000	0011	0000	
+4	-	0000	0000	0000	0000	Response code Command execution result OK: 0(0000 0000) NG: Not 0 (0000 0000)
+5	-	0000	0000	0000	0000	

Acquiring Unit Data

Acquires the specified processing unit data.

IMPORTANT

- In processing unit data setting/acquisition, you can get only numeric data. You cannot get character strings.
- Character string data such as comparison strings for general-purpose character tests, evaluation comparison strings for bar codes or 2D codes, or OCR recognition strings cannot be set or acquired.

Command (PLC to Sensor Controller)

First word in Command Area	Command code	Bit				Description
		12 to 15	8 to 11	4 to 7	0 to 3	
+2	1000	0001	0000	0000	0000	Command code
+3	0040	0000	0000	0100	0000	
+4	-	0000	0000	0000	0000	Unit No.
+5	-	0000	0000	0000	0000	
+6	-	0000	0000	0000	0000	Data number in the External Reference Tables.
+7	-	0000	0000	0000	0000	

Response (Sensor Controller to PLC)

First word in Response Area	Command code	Bit				Description
		12 to 15	8 to 11	4 to 7	0 to 3	
+2	1000	0001	0000	0000	0000	Command code
+3	0040	0000	0000	0100	0000	Response target command codes
+4	-	0000	0000	0000	0000	Response code
+5	-	0000	0000	0000	0000	Command execution result OK: 0(0000 0000) NG: Not 0 (0000 0000)
+6	-	0000	0000	0000	0000	Acquired data
+7	-	0000	0000	0000	0000	(Value multiplied by 1000)

Acquiring Date and Time

Acquires the date and time from the internal calendar timer in the Sensor Controller.

Command (PLC to Sensor Controller)

First word in Command Area	Command code	Bit				Description
		12 to 15	8 to 11	4 to 7	0 to 3	
+2	2000	0010	0000	0000	0000	Command code
+3	0040	0000	0000	0100	0000	

Response (Sensor Controller to PLC)

First word in Response Area	Command code	Bit				Description
		12 to 15	8 to 11	4 to 7	0 to 3	
+2	2000	0010	0000	0000	0000	Command code
+3	0040	0000	0000	0100	0000	Response target command codes
+4	-	0000	0000	0000	0000	Response code
+5	-	0000	0000	0000	0000	Command execution result OK: 0(0000 0000) NG: Not 0 (0000 0000)
+6	-	0000	0000	0000	0000	Year data: 1900 to 2100
+7	-	0000	0000	0000	0000	
+8	-	0000	0000	0000	0000	Month data: 1 to 12
+9	-	0000	0000	0000	0000	
+10	-	0000	0000	0000	0000	Date data: 1 to 31
+11	-	0000	0000	0000	0000	
+12	-	0000	0000	0000	0000	Hour data: 0 to 23
+13	-	0000	0000	0000	0000	
+14	-	0000	0000	0000	0000	Minute data: 0 to 59
+15	-	0000	0000	0000	0000	
+16	-	0000	0000	0000	0000	Second data: 0 to 59
+17	-	0000	0000	0000	0000	

Acquiring Version Information

Acquires the Sensor Controller version information.

Command (PLC to Sensor Controller)

First word in Command Area	Command code	Bit				Description
		12 to 15	8 to 11	4 to 7	0 to 3	
+2	3000	0011	0000	0000	0000	Command code
+3	0040	0000	0000	0100	0000	

Response (Sensor Controller to PLC)

First word in Response Area	Command code	Bit				Description
		12 to 15	8 to 11	4 to 7	0 to 3	
+2	3000	0011	0000	0000	0000	Command code
+3	0040	0000	0000	0100	0000	Response target command codes
+4	-	0000	0000	0000	0000	Response code
+5	-	0000	0000	0000	0000	Command execution result OK: 0(0000 0000) NG: Not 0 (0000 0000)
+6	-	0000	0000	0000	0000	Response data Version information character string
+7	-	0000	0000	0000	0000	
+8	-	0000	0000	0000	0000	
+9	-	0000	0000	0000	0000	
:	-	0000	0000	0000	0000	
:	-	0000	0000	0000	0000	

Acquiring Settings Related to Image Logging

Acquires settings related to image logging.

Command (PLC to Sensor Controller)

First word in Command Area	Command code	Bit				Description
		12 to 15	8 to 11	4 to 7	0 to 3	
+2	4000	0100	0000	0000	0000	Command code
+3	0040	0000	0000	0100	0000	
+4	0000	0000	0000	0000	0000	[Identifier 0][Identifier 1]
+5	0000	0000	0000	0000	0000	[Identifier 0]: Logging
+6	0000	0000	0000	0000	0000	[Identifier 1]: Identifier of setting to obtain
+7	0000	0000	0000	0000	0000	• imageLogging (image logging)
:	0000	0000	0000	0000	0000	• imageLoggingDirectory (image log saving destination folder name)
:	0000	0000	0000	0000	0000	• imageLoggingHeader (prefix of image log file name)
:	0000	0000	0000	0000	0000	• dataLogging (data logging)
:	0000	0000	0000	0000	0000	• dataLoggingDirectory (data log saving destination folder name)

Response (Sensor Controller to PLC)

First word in Response Area	Command code	Bit				Description
		12 to 15	8 to 11	4 to 7	0 to 3	
+2	4000	0100	0000	0000	0000	Command code
+3	0040	0000	0000	0100	0000	Response target command codes
+4	-	0000	0000	0000	0000	Response code
+5	-	0000	0000	0000	0000	Command execution result OK: 0(0000 0000) NG: Not 0 (0000 0000)
+6	-	0000	0000	0000	0000	[Identifier 0][Identifier 1]
+7	-	0000	0000	0000	0000	[Identifier 0]: Logging
+8	-	0000	0000	0000	0000	[Identifier 1]: Identifier of setting to obtain
+9	-	0000	0000	0000	0000	• For imageLogging (image log): 0 (will not save), 1 (save when NG), 2 (save all)
:	-	0000	0000	0000	0000	• For imageLoggingDirectory (image log saving destination folder name): Destination folder name*1 (half-width alphanumeric)
:	-	0000	0000	0000	0000	• For imageLoggingHeader (prefix of image log file name): Prefix of image log file name (half-width alphanumeric)
:	-	0000	0000	0000	0000	• For dataLogging (data logging): 0 (will not save), 1 (save when NG), 2 (save all)
:	-	0000	0000	0000	0000	• For dataLoggingDirectory: saving destination folder name (half-width alphanumeric)

*1: Regarding the storage destination folder

The storage destination folder differ according to the Sensor Controller series.

- FH series/FZ5-800/FZ5-1100/FZ5-1200 series

RAM disk: C:\Data\RAMDisk

External memory device: E:\, F:\

- Do not save to the any folder except RAMDisk and external memory device (such as C:\ProgramFiles\FZ).

It is possible not to perform correctly due to the decrease of Scene data storage region.

- FZ5-L series/FZ5-600 series

RAM disk: \RAMDisk

External memory device: \USBdisk, \USBdisk2

Getting Image Logging Folder Name

Gets the image logging folder name

Command (PLC to Sensor Controller)

First word in Command Area	Command code	Bit				Description
		12 to 15	8 to 11	4 to 7	0 to 3	
+2	4010	0100	0000	0001	0000	Command code
+3	0040	0000	0000	0100	0000	

Response (Sensor Controller to PLC)

First word in Response Area	Command code	Bit				Description
		12 to 15	8 to 11	4 to 7	0 to 3	
+2	4010	0011	0000	0000	0000	Command code
+3	0040	0000	0000	0111	0000	Response target command codes
+4	-	0000	0000	0000	0000	Response code
+5	-	0000	0000	0000	0000	Command execution result OK: 0(0000 0000) NG: Not 0 (0000 0000)
+6	-	0000	0000	0000	0000	Response data Folder name (absolute path)
+7	-	0000	0000	0000	0000	
:	-	0000	0000	0000	0000	

Getting Data Logging Folder Name

Gets the data logging folder name.

Command (PLC to Sensor Controller)

First word in Command Area	Command code	Bit				Description
		12 to 15	8 to 11	4 to 7	0 to 3	
+2	4020	0100	0000	0010	0000	Command code
+3	0040	0000	0000	0100	0000	

Response (Sensor Controller to PLC)

First word in Response Area	Command code	Bit				Description
		12 to 15	8 to 11	4 to 7	0 to 3	
+2	4020	0100	0000	0010	0000	Command code
+3	0040	0000	0000	0100	0000	Response target command codes
+4	-	0000	0000	0000	0000	Response code
+5	-	0000	0000	0000	0000	Command execution result OK: 0(0000 0000) NG: Not 0 (0000 0000)
+6	-	0000	0000	0000	0000	Response data Folder name (absolute path)
+7	-	0000	0000	0000	0000	
:	-	0000	0000	0000	0000	

Getting Screen Capture Folder Name

Gets the screen capture folder name.

Command (PLC to Sensor Controller)

First word in Command Area	Command code	Bit				Description
		12 to 15	8 to 11	4 to 7	0 to 3	
+2	4030	0100	0000	0011	0000	Command code
+3	0040	0000	0000	0100	0000	

Response (Sensor Controller to PLC)

First word in Response Area	Command code	Bit				Description
		12 to 15	8 to 11	4 to 7	0 to 3	
+2	4030	0100	0000	0011	0000	Command code Response target command codes
+3	0040	0000	0000	0100	0000	
+4	-	0000	0000	0000	0000	Response code Command execution result OK: 0(0000 0000) NG: Not 0 (0000 0000)
+5	-	0000	0000	0000	0000	
+6	-	0000	0000	0000	0000	Response data Folder name (absolute path)
+7	-	0000	0000	0000	0000	
:	-	0000	0000	0000	0000	

Getting Image Logging Prefix

Gets the prefix for the name of the file the image logging is saved to.

Command (PLC to Sensor Controller)

First word in Command Area	Command code	Bit				Description
		12 to 15	8 to 11	4 to 7	0 to 3	
+2	4040	0100	0000	0100	0000	Command code
+3	0040	0000	0000	0100	0000	

Response (Sensor Controller to PLC)

First word in Response Area	Command code	Bit				Description
		12 to 15	8 to 11	4 to 7	0 to 3	
+2	4040	0100	0000	0100	0000	Command code Response target command codes
+3	0040	0000	0000	0100	0000	
+4	-	0000	0000	0000	0000	Response code Command execution result OK: 0(0000 0000) NG: Not 0 (0000 0000)
+5	-	0000	0000	0000	0000	
+6	-	0000	0000	0000	0000	Response data Image logging prefix character string
+7	-	0000	0000	0000	0000	
:	-	0000	0000	0000	0000	

Getting Data Logging Condition

Gets the data logging conditions.

Command (PLC to Sensor Controller)

First word in Command Area	Command code	Bit				Description
		12 to 15	8 to 11	4 to 7	0 to 3	
+2	4050	0100	0000	0101	0000	Command code
+3	0040	0000	0000	0100	0000	

Response (Sensor Controller to PLC)

First word in Response Area	Command code	Bit				Description
		12 to 15	8 to 11	4 to 7	0 to 3	
+2	4050	0100	0000	0101	0000	Command code
+3	0040	0000	0000	0100	0000	Response target command codes
+4	-	0000	0000	0000	0000	Response code
+5	-	0000	0000	0000	0000	Command execution result OK: 0(0000 0000) NG: Not 0 (0000 0000)
+6	-	0000	0000	0000	0000	Response data
+7	-	0000	0000	0000	0000	Data logging condition gotten 0: None 1: Only NG 2: All

Get Parallel Terminal Offset

Gets the parallel DI terminal offset data.

The parallel DI terminal offset is the value that is added to the DI0-DI4 command parameter when a parallel command is executed. After the Set Parallel Terminal Offset command is executed, the response data becomes "OK".

Command (PLC to Sensor Controller)

First word in Command Area	Command code	Bit				Description
		12 to 15	8 to 11	4 to 7	0 to 3	
+2	4060	0100	0000	0110	0000	Command code
+3	0040	0000	0000	0100	0000	

Response (Sensor Controller to PLC)

First word in Response Area	Command code	Bit				Description
		12 to 15	8 to 11	4 to 7	0 to 3	
+2	4060	0100	0000	0110	0000	Command code
+3	0040	0000	0000	0100	0000	Response target command codes
+4	-	0000	0000	0000	0000	Response code
+5	-	0000	0000	0000	0000	Command execution result OK: 0(0000 0000) NG: Not 0 (0000 0000)
+6	-	0000	0000	0000	0000	Response data
+7	-	0000	0000	0000	0000	Acquired parallel DI terminal offset value 0 to 9999

Setting Unit Data

Sets the specified processing unit data.

IMPORTANT

- In processing unit data setting/acquisition, you can get only numeric data. You cannot get character strings.
- Character string data such as comparison strings for general-purpose character tests, evaluation comparison strings for bar codes or 2D codes, or OCR recognition strings cannot be set or acquired.

Command (PLC to Sensor Controller)

First word in Command Area	Command code	Bit				Description
		12 to 15	8 to 11	4 to 7	0 to 3	
+2	1000	0001	0000	0000	0000	Command code
+3	0050	0000	0000	0101	0000	
+4	0000	0000	0000	0000	0000	Unit No.
+5	0000	0000	0000	0000	0000	
+6	0000	0000	0000	0000	0000	Data number in the External Reference Tables
+7	0000	0000	0000	0000	0000	
+8	0000	0000	0000	0000	0000	Data to be set (Value multiplied by 1000)
+9	0000	0000	0000	0000	0000	

Response (Sensor Controller to PLC)

First word in Response Area	Command code	Bit				Description
		12 to 15	8 to 11	4 to 7	0 to 3	
+2	1000	0001	0000	0000	0000	Command code
+3	0050	0000	0000	0101	0000	Response target command codes
+4	0000	0000	0000	0000	0000	Response code
+5	0000	0000	0000	0000	0000	Command execution result OK: 0 (0000 0000) NG: Not 0 (0000 0000)

Setting Date and Time

Sets the date and time of the internal calendar timer in the Sensor Controller.

Command (PLC to Sensor Controller)

First word in Command Area	Command code	Bit				Description
		12 to 15	8 to 11	4 to 7	0 to 3	
+2	2000	0010	0000	0000	0000	Command code
+3	0050	0000	0000	0101	0000	
+4	0000	0000	0000	0000	0000	Year data: 1900 to 2100
+5	0000	0000	0000	0000	0000	
+6	0000	0000	0000	0000	0000	Month data: 1 to 12
+7	0000	0000	0000	0000	0000	
+8	0000	0000	0000	0000	0000	Date data: 1 to 31
+9	0000	0000	0000	0000	0000	
+10	0000	0000	0000	0000	0000	Hour data: 0 to 23
+11	0000	0000	0000	0000	0000	
+12	0000	0000	0000	0000	0000	Minute data: 0 to 59
+13	0000	0000	0000	0000	0000	
+14	0000	0000	0000	0000	0000	Second data: 0 to 59
+15	0000	0000	0000	0000	0000	

Response (Sensor Controller to PLC)

First word in Response Area	Command code	Bit				Description
		12 to 15	8 to 11	4 to 7	0 to 3	
+2	2000	0010	0000	0000	0000	Command code
+3	0050	0000	0000	0101	0000	Response target command codes
+4	0000	0000	0000	0000	0000	Response code
+5	0000	0000	0000	0000	0000	Command execution result OK: 0(0000 0000) NG: Not 0 (0000 0000)

Changes Settings Related to Image Logging

Changes settings related to image logging.

Command (PLC to Sensor Controller)

First word in Command Area	Command code	Bit				Description
		12 to 15	8 to 11	4 to 7	0 to 3	
+2	4000	0100	0000	0000	0000	Command code
+3	0050	0000	0000	0101	0000	
+4	0000	0000	0000	0000	0000	[Identifier 0] [Identifier 1] [Set value]
+5	0000	0000	0000	0000	0000	[Identifier 0]: Logging
+6	0000	0000	0000	0000	0000	[Identifier 1]: Identifier of settings data to set and set value
+7	0000	0000	0000	0000	0000	Separate the setting name and set value with 00 (NULL).
:	0000	0000	0000	0000	0000	<ul style="list-style-type: none"> ImageLogging + 0 (do not save)/1 (save only NG)/2 (save all) imageLoggingDirectory (image logging folder name) + <i>folder_name</i>^(*)(^(*)2) (single-byte alphanumeric characters) imageLoggingHeader + <i>Prefix_for_image_logging_file_name</i> (single-byte alphanumeric characters) DataLogging + 0 (do not save)/1 (save only NG)/2 (save all) dataLoggingDirectory (data logging folder name) + <i>folder_name</i> (single-byte alphanumeric characters)
:	0000	0000	0000	0000	0000	

*1: If the name of a folder that does not exist is specified, a new folder will be created.

*2: Regarding the storage destination folder

The storage destination folder differ according to the Sensor Controller series.

- FH series/FZ5-800/FZ5-1100/FZ5-1200 series

RAM disk: C:\Data\RAMDisk

External memory device: E:\, F:\

- Do not save to the any folder except RAMDisk and external memory device (such as C:\ProgramFiles\FZ). It is possible not to perform correctly due to the decrease of Scene data storage region.

- FZ5-L series/FZ5-600 series

RAM disk: \RAMDisk

External memory device: \USBdisk, \USBdisk2

Response (Sensor Controller to PLC)

First word in Response Area	Command code	Bit				Description
		12 to 15	8 to 11	4 to 7	0 to 3	
+2	4000	0100	0000	0000	0000	Command code
+3	0050	0000	0000	0101	0000	Response target command codes
+4	0000	0000	0000	0000	0000	Response code
+5	0000	0000	0000	0000	0000	Command execution result OK: 0(0000 0000) NG: Not 0 (0000 0000)

Image Logging Folder Name Setting

Sets the image logging folder name.

Command (PLC to Sensor Controller)

First word in Command Area	Command code	Bit				Description
		12 to 15	8 to 11	4 to 7	0 to 3	
+2	4010	0100	0000	0001	0000	Command code
+3	0050	0000	0000	0101	0000	
+4	-	0000	0000	0000	0000	Name of the image capture folder with the absolute path Up to 230 characters
+5	-	0000	0000	0000	0000	
:	-	0000	0000	0000	0000	

Response (Sensor Controller to PLC)

First word in Response Area	Command code	Bit				Description
		12 to 15	8 to 11	4 to 7	0 to 3	
+2	4010	0100	0000	0001	0000	Command code
+3	0050	0000	0000	0101	0000	Response target command codes
+4	-	0000	0000	0000	0000	Response code
+5	-	0000	0000	0000	0000	Command execution result OK: 0(0000 0000) NG: Not 0 (0000 0000)

Data Logging Folder Name Setting

Sets the data logging folder name.

Command (PLC to Sensor Controller)

First word in Command Area	Command code	Bit				Description
		12 to 15	8 to 11	4 to 7	0 to 3	
+2	4020	0100	0000	0010	0000	Command code
+3	0050	0000	0000	0101	0000	
+4	-	0000	0000	0000	0000	Name of the data logging folder with the absolute path. Up to 247 characters
+5	-	0000	0000	0000	0000	
:	-	0000	0000	0000	0000	

Response (Sensor Controller to PLC)

First word in Response Area	Command code	Bit				Description
		12 to 15	8 to 11	4 to 7	0 to 3	
+2	4020	0100	0000	0010	0000	Command code Response target command codes
+3	0050	0000	0000	0101	0000	
+4	-	0000	0000	0000	0000	Response code Command execution result OK: 0(0000 0000) NG: Not 0 (0000 0000)
+5	-	0000	0000	0000	0000	

Screen Capture Folder Name Setting

Sets the screen capture folder name.

Command (PLC to Sensor Controller)

First word in Command Area	Command code	Bit				Description
		12 to 15	8 to 11	4 to 7	0 to 3	
+2	4030	0100	0000	0011	0000	Command code
+3	0050	0000	0000	0101	0000	
+4	-	0000	0000	0000	0000	Name of the image capture folder with the absolute path. Up to 227 characters
+5	-	0000	0000	0000	0000	
:	-	0000	0000	0000	0000	

Response (Sensor Controller to PLC)

First word in Response Area	Command code	Bit				Description
		12 to 15	8 to 11	4 to 7	0 to 3	
+2	4030	0100	0000	0011	0000	Command code Response target command codes
+3	0050	0000	0000	0101	0000	
+4	-	0000	0000	0000	0000	Response code Command execution result OK: 0(0000 0000) NG: Not 0 (0000 0000)
+5	-	0000	0000	0000	0000	

Image Logging Prefix Setting

Sets the prefix for the name of the file the image logging is saved to.

Command (PLC to Sensor Controller)

First word in Command Area	Command code	Bit				Description
		12 to 15	8 to 11	4 to 7	0 to 3	
+2	4040	0100	0000	0100	0000	Command code
+3	0050	0000	0000	0101	0000	
+4	-	0000	0000	0000	0000	Image logging prefix Up to 32 characters
+5	-	0000	0000	0000	0000	
:	-	0000	0000	0000	0000	

Response (Sensor Controller to PLC)

First word in Response Area	Command code	Bit				Description
		12 to 15	8 to 11	4 to 7	0 to 3	
+2	4040	0100	0000	0100	0000	Command code
+3	0050	0000	0000	0101	0000	Response target command codes
+4	-	0000	0000	0000	0000	Response code
+5	-	0000	0000	0000	0000	Command execution result OK: 0(0000 0000) NG: Not 0 (0000 0000)

Data Logging Condition Setting

Sets the data logging conditions.

Command (PLC to Sensor Controller)

First word in Command Area	Command code	Bit				Description
		12 to 15	8 to 11	4 to 7	0 to 3	
+2	4050	0100	0000	0101	0000	Command code
+3	0050	0000	0000	0101	0000	
+4	-	0000	0000	0000	0000	Data logging condition
+5	-	0000	0000	0000	0000	0: None 1: Only NG 2: All

Response (Sensor Controller to PLC)

First word in Response Area	Command code	Bit				Description
		12 to 15	8 to 11	4 to 7	0 to 3	
+2	4050	0100	0000	0101	0000	Command code
+3	0050	0000	0000	0101	0000	Response target command codes
+4	-	0000	0000	0000	0000	Response code
+5	-	0000	0000	0000	0000	Command execution result OK: 0(0000 0000) NG: Not 0 (0000 0000)

Set Parallel Terminal Offset

Sets the parallel DI terminal offset data.

The parallel DI terminal offset is the value that is added to the DI0-DI4 command parameter when a parallel command is executed.

This is useful in the following cases.

Example)

This example is for creating a custom communications command for parallel communications that sets a numeric value with DI0 to DI6.

- Without an Offset:

You can set only values between the minimum value of 0 and the maximum value of 127 (0111 1111 binary).

- With an Offset:

Adding an offset of 100 allows you to specify numeric values from a minimum value of 100 to a maximum value of 227 (127 + 100) by specifying the same values as those used without offsets.

Command (PLC to Sensor Controller)

First word in Command Area	Command code	Bit				Description
		12 to 15	8 to 11	4 to 7	0 to 3	
+2	4060	0100	0000	0110	0000	Command code
+3	0050	0000	0000	0101	0000	
+4	-	0000	0000	0000	0000	Parallel DI terminal offset data 0 to 9999
+5	-	0000	0000	0000	0000	

Response (Sensor Controller to PLC)

First word in Response Area	Command code	Bit				Description
		12 to 15	8 to 11	4 to 7	0 to 3	
+2	4060	0100	0000	0110	0000	Command code
+3	0050	0000	0000	0101	0000	Response target command codes
+4	-	0000	0000	0000	0000	Response code
+5	-	0000	0000	0000	0000	Command execution result OK: 0(0000 0000) NG: Not 0 (0000 0000)

Loading Scene Data

Reads scene data.

Command (PLC to Sensor Controller)

First word in Command Area	Command code	Bit				Description
		12 to 15	8 to 11	4 to 7	0 to 3	
+2	1000	0001	0000	0000	0000	Command code
+3	0060	0000	0000	0110	0000	
+4	-	0000	0000	0000	0000	Number of scene to read
+5	-	0000	0000	0000	0000	
+6	-	0000	0000	0000	0000	Name of the file to be read with the absolute path. Up to 256 characters
+7	-	0000	0000	0000	0000	
:	-	0000	0000	0000	0000	

Response (Sensor Controller to PLC)

First word in Response Area	Command code	Bit				Description
		12 to 15	8 to 11	4 to 7	0 to 3	
+2	1000	0001	0000	0000	0000	Command code
+3	0060	0000	0000	0110	0000	Response target command codes
+4	-	0000	0000	0000	0000	Response code
+5	-	0000	0000	0000	0000	Command execution result OK: 0(0000 0000) NG: Not 0 (0000 0000)

Loading Scene Group Data

Reads scene group data.

Command (PLC to Sensor Controller)

First word in Command Area	Command code	Bit				Description
		12 to 15	8 to 11	4 to 7	0 to 3	
+2	2000	0010	0000	0000	0000	Command code
+3	0060	0000	0000	0110	0000	
+4	-	0000	0000	0000	0000	Number of scene group to read
+5	-	0000	0000	0000	0000	
+6	-	0000	0000	0000	0000	Name of the file to be read with an absolute path Up to 256 characters
+7	-	0000	0000	0000	0000	
:	-	0000	0000	0000	0000	

Response (Sensor Controller to PLC)

First word in Response Area	Command code	Bit				Description
		12 to 15	8 to 11	4 to 7	0 to 3	
+2	2000	0010	0000	0000	0000	Command code
+3	0060	0000	0000	0110	0000	Response target command codes
+4	-	0000	0000	0000	0000	Response code
+5	-	0000	0000	0000	0000	Command execution result OK: 0(0000 0000) NG: Not 0 (0000 0000)

Loading System Data

Reads system data.

Command (PLC to Sensor Controller)

First word in Command Area	Command code	Bit				Description
		12 to 15	8 to 11	4 to 7	0 to 3	
+2	3000	0011	0000	0000	0000	Command code
+3	0060	0000	0000	0110	0000	
+4	-	0000	0000	0000	0000	Name of the file to be read with an absolute path Up to 256 characters
+5	-	0000	0000	0000	0000	
:	-	0000	0000	0000	0000	

Response (Sensor Controller to PLC)

First word in Response Area	Command code	Bit				Description
		12 to 15	8 to 11	4 to 7	0 to 3	
+2	3000	0011	0000	0000	0000	Command code
+3	0060	0000	0000	0110	0000	Response target command codes
+4	-	0000	0000	0000	0000	Response code
+5	-	0000	0000	0000	0000	Command execution result OK: 0(0000 0000) NG: Not 0 (0000 0000)

Loading All Data

Reads system + scene group 0 data.

IMPORTANT

With this command, be sure to restart the Sensor Controller after reading the system + scene group 0 data to enable the data that was read.

Command (PLC to Sensor Controller)

First word in Command Area	Command code	Bit				Description
		12 to 15	8 to 11	4 to 7	0 to 3	
+2	5000	0101	0000	0000	0000	Command code
+3	0060	0000	0000	0110	0000	
+4	-	0000	0000	0000	0000	
+5	-	0000	0000	0000	0000	Name of the file to be read with an absolute path Up to 256 characters
:	-	0000	0000	0000	0000	

Response (Sensor Controller to PLC)

First word in Response Area	Command code	Bit				Description
		12 to 15	8 to 11	4 to 7	0 to 3	
+2	5000	0101	0000	0000	0000	Command code
+3	0060	0000	0000	0110	0000	Response target command codes
+4	-	0000	0000	0000	0000	Response code
+5	-	0000	0000	0000	0000	Command execution result OK: 0(0000 0000) NG: Not 0 (0000 0000)

Saving Scene Data

Saves scene data.

Command (PLC to Sensor Controller)

First word in Command Area	Command code	Bit				Description
		12 to 15	8 to 11	4 to 7	0 to 3	
+2	1000	0001	0000	0000	0000	Command code
+3	0070	0000	0000	0111	0000	
+4	-	0000	0000	0000	0000	Number of scene to save
+5	-	0000	0000	0000	0000	
+6	-	0000	0000	0000	0000	[Absolute path of save destination and save file name] Up to 256 characters
+7	-	0000	0000	0000	0000	
:	-	0000	0000	0000	0000	
+135	-	0000	0000	0000	0000	

Response (Sensor Controller to PLC)

First word in Response Area	Command code	Bit				Description
		12 to 15	8 to 11	4 to 7	0 to 3	
+2	1000	0001	0000	0000	0000	Command code
+3	0070	0000	0000	0111	0000	Response target command codes
+4	-	0000	0000	0000	0000	Response code
+5	-	0000	0000	0000	0000	Command execution result OK: 0(0000 0000) NG: Not 0 (0000 0000)

Saving Scene Group Data

Saves scene group data.

Command (PLC to Sensor Controller)

First word in Command Area	Command code	Bit				Description
		12 to 15	8 to 11	4 to 7	0 to 3	
+2	2000	0010	0000	0000	0000	Command code
+3	0070	0000	0000	0111	0000	
+4	-	0000	0000	0000	0000	Number of scene group to save
+5	-	0000	0000	0000	0000	
+6	-	0000	0000	0000	0000	[Absolute path of save destination and save file name] Up to 256 characters
+7	-	0000	0000	0000	0000	
:	-	0000	0000	0000	0000	

Response (Sensor Controller to PLC)

First word in Response Area	Command code	Bit				Description
		12 to 15	8 to 11	4 to 7	0 to 3	
+2	2000	0010	0000	0000	0000	Command code
+3	0070	0000	0000	0111	0000	Response target command codes
+4	-	0000	0000	0000	0000	Response code
+5	-	0000	0000	0000	0000	Command execution result OK: 0(0000 0000) NG: Not 0 (0000 0000)

Saving System Data

Saves system data.

Command (PLC to Sensor Controller)

First word in Command Area	Command code	Bit				Description
		12 to 15	8 to 11	4 to 7	0 to 3	
+2	3000	0011	0000	0000	0000	Command code
+3	0070	0000	0000	0111	0000	
+4	-	0000	0000	0000	0000	[Absolute path of save destination and save file name]
+5	-	0000	0000	0000	0000	Up to 256 characters
:	-	0000	0000	0000	0000	

Response (Sensor Controller to PLC)

First word in Response Area	Command code	Bit				Description
		12 to 15	8 to 11	4 to 7	0 to 3	
+2	3000	0011	0000	0000	0000	Command code
+3	0070	0000	0000	0111	0000	Response target command codes
+4	-	0000	0000	0000	0000	Response code
+5	-	0000	0000	0000	0000	Command execution result OK: 0(0000 0000) NG: Not 0 (0000 0000)

Saves Image Data

Saves the image data that is saved in the Sensor Controller's memory

Command (PLC to Sensor Controller)

First word in Command Area	Command code	Bit				Description
		12 to 15	8 to 11	4 to 7	0 to 3	
+2	4000	0100	0000	0000	0000	Command code
+3	0070	0000	0000	0111	0000	
+4	-	0000	0000	0000	0000	Image data No.
+5	-	0000	0000	0000	0000	
+6	-	0000	0000	0000	0000	[Absolute path of save destination and file name] Up to 256 characters
+7	-	0000	0000	0000	0000	
:	-	0000	0000	0000	0000	
:	-	0000	0000	0000	0000	

Response (Sensor Controller to PLC)

First word in Response Area	Command code	Bit				Description
		12 to 15	8 to 11	4 to 7	0 to 3	
+2	4000	0100	0000	0000	0000	Command code
+3	0070	0000	0000	0111	0000	Response target command codes
+4	-	0000	0000	0000	0000	Response code
+5	-	0000	0000	0000	0000	Command execution result OK: 0(0000 0000) NG: Not 0 (0000 0000)

Saving All Image Data

Writes all of the image data that is saved in the Sensor Controller's memory to ifz format in external memory.

Command (PLC to Sensor Controller)

First word in Command Area	Command code	Bit				Description
		12 to 15	8 to 11	4 to 7	0 to 3	
+2	4010	0100	0000	0001	0000	Command code
+3	0070	0000	0000	0111	0000	
+4	-	0000	0000	0000	0000	[Absolute path of save destination] (The file name is given automatically.) Up to 256 characters
+5	-	0000	0000	0000	0000	
:	-	0000	0000	0000	0000	

Response (Sensor Controller to PLC)

First word in Response Area	Command code	Bit				Description
		12 to 15	8 to 11	4 to 7	0 to 3	
+2	4010	0100	0000	0001	0000	Command code Response target command codes
+3	0070	0000	0000	0111	0000	
+4	-	0000	0000	0000	0000	Response code Command execution result OK: 0(0000 0000) NG: Not 0 (0000 0000)
+5	-	0000	0000	0000	0000	

Saving Last Logging Image

Saves the last logging image.

Command (PLC to Sensor Controller)

First word in Command Area	Command code	Bit				Description
		12 to 15	8 to 11	4 to 7	0 to 3	
+2	4020	0100	0000	0010	0000	Command code
+3	0070	0000	0000	0111	0000	
+4	-	0000	0000	0000	0000	[Absolute path of save destination and save file name] Up to 256 characters
+5	-	0000	0000	0000	0000	
:	-	0000	0000	0000	0000	

Response (Sensor Controller to PLC)

First word in Response Area	Command code	Bit				Description
		12 to 15	8 to 11	4 to 7	0 to 3	
+2	4020	0100	0000	0010	0000	Command code Response target command codes
+3	0070	0000	0000	0111	0000	
+4	-	0000	0000	0000	0000	Response code Command execution result OK: 0(0000 0000) NG: Not 0 (0000 0000)
+5	-	0000	0000	0000	0000	

Saving All Data

The system + scene group 0 data currently being used by the Sensor Controller is saved to a file.

Command (PLC to Sensor Controller)

First word in Command Area	Command code	Bit				Description
		12 to 15	8 to 11	4 to 7	0 to 3	
+2	5000	0101	0000	0000	0000	Command code
+3	0070	0000	0000	0111	0000	
+4	-	0000	0000	0000	0000	[Absolute path of save destination and save file name] Up to 256 characters
+5	-	0000	0000	0000	0000	
:	-	0000	0000	0000	0000	

Response (Sensor Controller to PLC)

First word in Response Area	Command code	Bit				Description
		12 to 15	8 to 11	4 to 7	0 to 3	
+2	5000	0101	0000	0000	0000	Command code
+3	0070	0000	0000	0111	0000	Response target command codes
+4	-	0000	0000	0000	0000	Response code
+5	-	0000	0000	0000	0000	Command execution result OK: 0(0000 0000) NG: Not 0 (0000 0000)

Screen Capture

Captures the screen. The argument specifies a file name and extension in the absolute path of the save destination. The extension is "bmp". If there is no argument, the folder in which the captured image is saved is determined by the system data settings, and the file name is the time stamp. The extension is "bmp". (Refer to ► *Capturing Screen Images in the Vision System FH/FZ5 Series User's Manual (Cat. No. Z365).*)

Command (PLC to Sensor Controller)

First word in Command Area	Command code	Bit				Description
		12 to 15	8 to 11	4 to 7	0 to 3	
+2	6000	0110	0000	0000	0000	Command code
+3	0070	0000	0000	0111	0000	
+4	-	0000	0000	0000	0000	Absolute path of save destination and save file name
+5	-	0000	0000	0000	0000	When 00 00 00 00 is set in +4 or higher, the command operates without an argument
:	-	0000	0000	0000	0000	

Response (Sensor Controller to PLC)

First word in Response Area	Command code	Bit				Description
		12 to 15	8 to 11	4 to 7	0 to 3	
+2	6000	0110	0000	0000	0000	Command code
+3	0070	0000	0000	0111	0000	Response target command codes
+4	-	0000	0000	0000	0000	Response code
+5	-	0000	0000	0000	0000	Command execution result OK: 0(0000 0000) NG: Not 0 (0000 0000)

Non-procedure Command Details

This section describes details of commands used in non-procedure communication.

ALLIMAGESAVE or AIS

Writes all the image data in the image buffer (specified with [main unit logging image]) to external memory in ifz format.

<Command format>



or



<Response format>

When processing is performed normally

OK^{C_R}

When processing is not performed normally

ER^{C_R}

<Parameters explanation>

Destination folder name	The folder name to save image data. Specify the folder name as an absolute path. The save destination to use differs by Sensor Controller model.		
	Save destination	FH series/FZ5-800 series/FZ5-1100 series/FZ5-1200 series ^{*1}	FZ5-L series/FZ5-600 series
	RAMDisk	C:\Data\RAMDisk	\RAMDISK
	External memory	E:\, F:\, G:\, H:\, M:\ (FH series only)	\USBdisk to \USBdisk3

*1: Do not specify a save destination other than RAMDisk or External memory.
The saved Scene data area may be reduced and the Sensor Controller will not perform correctly.

(Example)

When you save the data to "IMG01" folder of the external memory:

<Command>

A I S | \ U S B D i s k \ I M G 0 1 \ | C_R

<Response>

OK^{C_R}

BKDLOAD

Reads system + scene group 0 data.

<Command format>

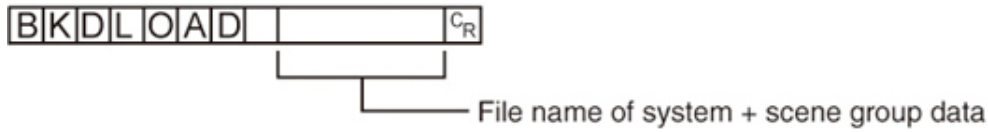

<Response format>

When processing is performed normally

OK^{CR}

When processing is not performed normally

ER^{CR}

<Parameters explanation>

Destination folder name	The name of the file containing the System data and Scene group 0 data you wish to load. Specify the file name as an absolute path. The file name needs the "BKD" extension. The file which has "BKD" extension can be load. The load destination to use differs by Sensor Controller model.		
	Load destination	FH series/FZ5-800 series/FZ5-1100 series/FZ5-1200 series	FZ5-L series/FZ5-600 series
	RAMDisk	C:\Data\RAMDisk	\RAMDISK
External memory	E:\, F:\, G:\, H:\, M:\ (FH series only)	\USBdisk to \USBdisk3	

IMPORTANT

- Do not turn off power to the Sensor Controller until there is a response.

(Example)

When you load the following case from the Sensor Controller:

- Drive name: USBDisk2
- Folder name of the external memory: IMG01
- File name: LABEL1.BKD

<Command>

BKDLOAD \ USBDisk2 \ IMG01 \ LABEL1.BKD^{CR}

<Response>

OK^{CR}

BKDSAVE

The system + scene group 0 data currently being used by the Sensor Controller is saved to a file.

<Command format>



<Response format>

When processing is performed normally

OK^{C_R}

When processing is not performed normally

ER^{C_R}

<Parameters explanation>

Destination folder name	The name of the file containing the System data and Scene group 0 data you wish to save. Specify the folder name as an absolute path. The file name needs the "BKD" extension. The save destination to use differs by Sensor Controller model.		
	Save destination	FH series/FZ5-800 series/FZ5-1100 series/FZ5-1200 series ^{*1}	FZ5-L series/FZ5-600 series
	RAMDisk	C:\Data\RAMDisk	\RAMDISK
External memory	E:\, F:\, G:\, H:\, M:\ (FH series only)	\USBdisk to \USBdisk3	

*1: Do not specify a save destination other than RAMDisk or External memory, i.e. C:\ProgramFiles\FZ
The saved Scene data area may be reduced and the Sensor Controller will not perform correctly.

IMPORTANT

- Do not turn off power to the Sensor Controller until there is a response.

(Example)

When you save the following case to the Sensor Controller:

- Data: The current System + Scene group 0
- Drive name: USBDisk2
- Folder name of the external memory: IMG01
- File name: LABEL1.BKD

<Command>

BKDSAVE \ USBDisk2 \ IMG01 \ LABEL1.BKD C_R

<Response>

OK^{C_R}

BRUNCHSTART or BFU

Branches to the flow head (processing unit No. 0). This command can only be executed when the corresponding flow control processing item is used.

<Command format>

B R U N C H S T A R T ^{C_R}

or

B F U ^{C_R}

<Response format>

When processing is performed normally

O K ^{C_R}

When processing is not performed normally

E R ^{C_R}

CLRMEAS

Clears all of the measurement values of the current scene.

<Command format>

C L R M E A S ^{C_R}

<Response format>

When processing is performed normally

O K ^{C_R}

When processing is not performed normally

E R ^{C_R}

Window display status after clearing

Judgement result	Unmeasured (0)
Value	0
Character string	Null character

CPYSCENE or CSD

Copies the data for the scene with the number specified with command argument 1 to the scene with the number specified with command argument 2. If there is already data at the copy destination, the copied data is written over that data.

<Command format>

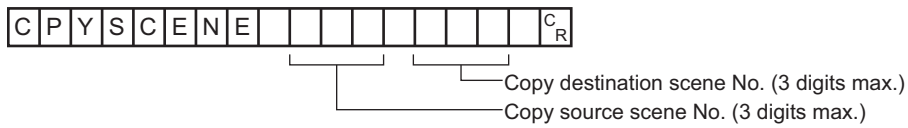

or

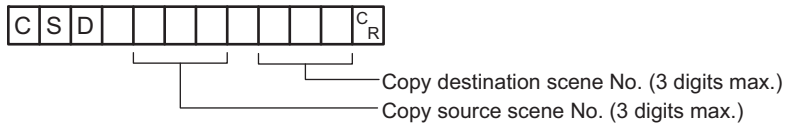

<Response format>

When processing is performed normally

OK^{CR}

When processing is not performed normally

ER^{CR}

<Parameters explanation>

Copy destination scene No.	Specifies the scene No. to copy from (0 to the number of scenes in the scene group – 1).
Copy destination scene No.	Specifies the scene No. to copy to (0 to the number of scenes in the scene group – 1).

(Example)

Copying the scene data for Scene 2 to Scene 10

<Command>

CSD 2 10^{CR}

<Response>

OK^{CR}

DATALOGCOND or DLC

Getting the data logging condition

Gets the data logging condition for system data.

Gets the "data logging condition" on the logging setting screen.

<Command format>

D A T A L O G C O N D ^{C_R}

or

D L C ^{C_R}

<Response format>

When processing is performed normally

Data logging condition ^{C_R}

OK ^{C_R}

When processing is not performed normally

ER ^{C_R}

<Parameters explanation>

Data logging condition	0: None 1: Only NG 2: All
------------------------	---------------------------------

(Example)

When data logging condition is set to "None".

<Command>

D L C ^{C_R}

<Response>

0 ^{C_R}

OK ^{C_R}

Setting the data logging condition

Sets the data logging conditions for system data.

Sets the "Data logging condition" on the Logging Setting window .

<Command format>

DATA LOG COND ^{C_R}

└── Data logging condition

or

DLC ^{C_R}

└── Data logging condition

<Response format>

When processing is performed normally

OK ^{C_R}

When processing is not performed normally

ER ^{C_R}

<Parameters explanation>

Data logging condition	0: None 1: Only NG 2: All
------------------------	---------------------------------

(Example)

When setting the data logging condition to "All"

<Command>

DLC 2 ^{C_R}

<Response>

OK ^{C_R}

DATALOGFOLDER or DLF

Getting the data logging folder name

Gets the set data logging folder name.

<Command format>

DATALOGFOLDER^{C_R}

or

DLF^{C_R}

<Response format>

When processing is performed normally

Data logging folder name^{C_R}

OK^{C_R}

When processing is not performed normally

ER^{C_R}

<Parameters explanation>

Data logging folder name	Responds with the data logging folder name with its absolute path.
--------------------------	--

(Example)

When setting the logging data save destination to "RAMDisk"

<Command>

DLF^{C_R}

<Response>

¥RAMDisk¥^{C_R}

OK^{C_R}

Setting the data logging folder name

Sets the data logging folder name.

<Command format>

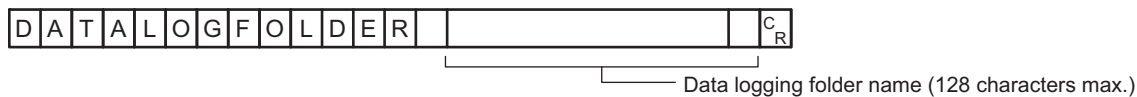

or

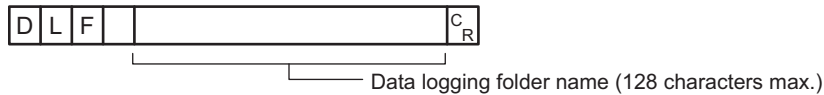

<Response format>

When processing is performed normally

OK^{C_R}

When processing is not performed normally

ER^{C_R}

<Parameters explanation>

Data logging folder name	The name of the file containing the data when data logging performs. Specify the file name as an absolute path. The save destination to use differs by Sensor Controller model.		
	Save destination	FH series/FZ5-800 series/FZ5-1100 series/FZ5-1200 series ^{*1}	FZ5-L series/FZ5-600 series
	RAMDisk	C:\Data\RAMDisk	\RAMDISK
External memory	E:\, F:\, G:\, H:\, M:\ (FH series only)	\USBdisk to \USBdisk3	

*1: Do not specify a save destination other than RAMDisk or External memory, i.e. C:\ProgramFiles\FZ
The saved Scene data area may be reduced and the Sensor Controller will not perform correctly.

(Example)

When setting the data logging folder name to "USBdisk"

<Command>

D L F ¥ U S B D i s k ¥ C_R

<Response>

OK^{C_R}

DATASAVE

Saves System + Scene group data to the Sensor Controller's memory.

<Command format>

DATASAVE^{CR}

<Response format>

When processing is performed normally

OK^{CR}

When processing is not performed normally

ER^{CR}

Note

- Executing DATASAVE command while you use Scene group 1 to 31, System + Scene group data is saved to the Sensor Controller's memory.
 - Do not turn off power to the Sensor Controller until there is a response.
-

DATE

Acquiring date and time

Acquires the date and time from the internal calendar timer in the Sensor Controller.

<Command format>

DATE^{CR}

<Response format>

When processing is performed normally

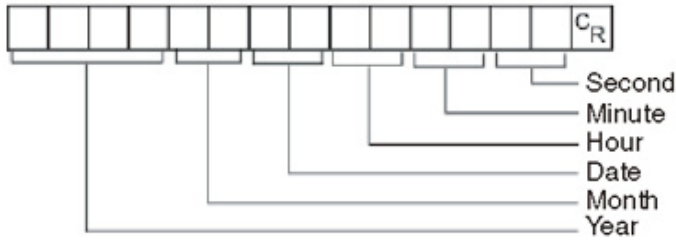

OK^{CR}

When processing is not performed normally

ER^{CR}

<Parameters explanation>

Year/Month/Date/Hour/Minute/ Second	Year: 4 digits Month: 2 digits Date: 2 digits Hour: 2 digits Minute: 2 digits Second: 2 digits
--	---

(Example)

When the current date and time is 08/30/2007, 12:30:00

<Command>

DATE^{CR}

<Response>

20070830123000^{CR}

Setting date and time

Changes the date and time of the internal calendar timer in the Sensor Controller.

<Command format>

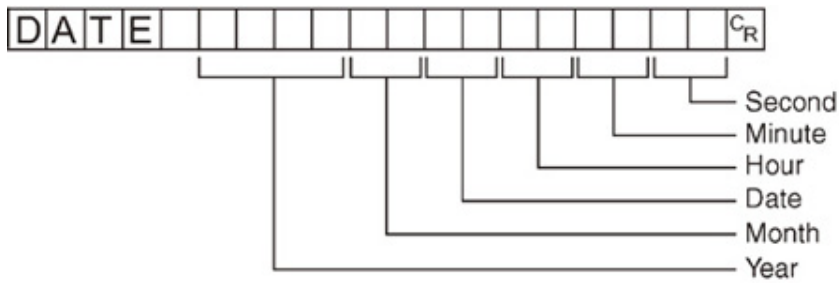

<Response format>

When processing is performed normally

OK^{CR}

When processing is not performed normally

ER^{CR}

Note

- <Hour: 2 digits>, <Minute: 2 digits>, and <Second: 2 digits> can be omitted during setting. Settings cannot be updated when these are omitted, however, and the previous time will be kept unchanged. Allowable omission patterns include "omitting <second> only", "omitting <minute> and <second>", and "omitting <hour>, <minute>, and <second>". Patterns that cannot be used include "omitting <hour> only" and "omitting <minute> only".

(Example)

When changing the date and time to 8/30/2007, 12:30:00

<Command>

DATE 20070830123000^{CR}

<Response>

OK^{CR}

DELSCENE or DSD

Deletes the data for the scene whose number is specified with command argument 1.

<Command format>

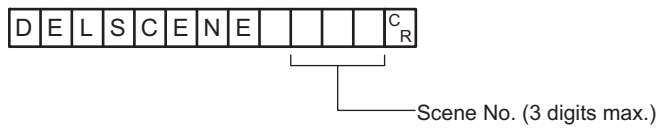

or

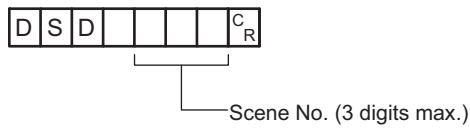

<Response format>

When processing is performed normally

OK_{C_R}

When processing is not performed normally

ER_{C_R}

<Parameters explanation>

Scene No.	Specify the scene No. to delete the scene data for (0 to the number of scenes in the scene group -1).
-----------	---

(Example)

Deleting the scene data for Scene 2

<Command>

D	S	D		2	C _R
---	---	---	--	---	----------------

<Response>

OK_{C_R}

DIOFFSET or DIO

Gets or sets the value of the parallel DI terminal offset data.

The parallel DI terminal offset is the value that is added to the DI0-DI4 command parameter when a parallel command is executed.

It is convenient to use a parallel DI terminal offset in cases such as the following.

Example: Creating a Custom Communications Command for Parallel Communications That Sets a Numeric Value with DI0 to DI6

- Without an Offset:
You can set only values between the minimum value of 0 and the maximum value of 127 (0111 1111 binary).
- With an Offset:
Adding an offset of 100 allows you to specify numeric values from a minimum value of 100 to a maximum value of 227 (127 + 100) by specifying the same values as those used without offsets.

Getting the parallel DI terminal offset data

Acquires the parallel DI terminal offset data.

After the Set Parallel Terminal Offset command is executed, the response data becomes "OK".

<Command format>

D I O F F S E T^{C_R}

or

D I O^{C_R}

<Response format>

When processing is performed normally

Terminal offset data^{C_R}

OK^{C_R}

When processing is not performed normally

ER^{C_R}

<Parameters explanation>

Parallel DI terminal offset data	This is the value that is set for the parallel DI terminal offset data (0 - 9999).
----------------------------------	--

(Example)

When the parallel DI terminal offset data is "10"

Note

When the value of the parallel DI terminal offset data is set to "10", the Switch Scene parallel command will change the scene to scene 10 instead of scene 0 when "0" is specified in the target scene parameter.

<Command>

D I O^{C_R}

<Response>

10^{C_R}

OK^{C_R}

Sets the parallel DI terminal offset data

Sets the parallel DI terminal offset data.

<Command format>

D I O F F S E T ^{C_R}

Parallel DI terminal offset data (max. 4 digits)

or

D I O ^{C_R}

Parallel DI terminal offset data (max. 4 digits)

<Response format>

When processing is performed normally

OK^{C_R}

When processing is not performed normally

ER^{C_R}

<Parameters explanation>

Parallel DI terminal offset data	Specify the parallel DI terminal offset data (0 - 9999).
----------------------------------	--

(Example)

Setting the parallel DI terminal offset data to "10"

<Command>

D I O 10^{C_R}

<Response>

OK^{C_R}

DIPORTCOND or DPC

Gets the ON/OFF states of all parallel DI terminals at once.

For how to use the command to acquire status, refer to the following example.

Example)

To acquire the parallel DI terminal status of Line 0.

1. Send the parallel DI terminal status command to the port number assigned to Line 0.
2. A response of the parallel DI terminal status will be received.

<Command format>

DIPORTCOND^{C_R}

or

DPC^{C_R}

<Response format>

When processing is performed normally

Terminal state^{C_R}

OK^{C_R}

When processing is not performed normally

ER^{C_R}

<Parameters explanation>

Terminal state	Responds with the DI0-DI7 states (0-255). <ul style="list-style-type: none"> • 1st bit: DI0 • 2nd bit: DI1 • : • 8th bit: DI7
----------------	---

IMPORTANT

This command gets the terminal status of each line by specifying its port number.

When getting the terminal status of an unusable line, the response code will be OK and the response data will always be 0. Verify the received data by changing the actual parallel terminal status.

(Example)

When DI0 and DI4 are ON

<Command>

DPC^{C_R}

<Response>

17^{C_R}

OK^{C_R}

DOPORTCOND or DPC

Sets the ON/OFF states of all parallel DO terminals at once.

For how to set the DO terminal status, refer to the following:

Example)

When you set the parallel DO terminal status of Line 0 to ON:

1. Set the command which turn the terminal status ON to the parallel DO terminal of assignment BIT.
2. Sends the command which you set the above step 1 to the port number of Line 0.
3. Executed result is responded.

<Command format>

D	O	P	O	R	T	C	O	N	D							C _R
---	---	---	---	---	---	---	---	---	---	--	--	--	--	--	--	----------------

└── Terminal state (max. 5 digits)

or

D	P	C							C _R
---	---	---	--	--	--	--	--	--	----------------

└── Terminal state (max. 5 digits)

<Response format>

When processing is performed normally

O	K	C _R
---	---	----------------

When processing is not performed normally

E	R	C _R
---	---	----------------

<Parameters explanation>

	Specify the DO terminals to switch ON (0-65535).
Terminal state	<ul style="list-style-type: none"> • 1st bit: DO0 • 2nd bit: DO1 <li style="text-align: center;">: • 16th bit: DO15

IMPORTANT

Sending this command to the each lines assigned port number, can set the specified terminal status.

When you set the unusable or different terminal status of lines, the response code is OK and the status is be disposed.

Make sure to check the acquired data by actually changing the parallel terminal status.

(Example)

When setting DO0 and DO4 ON

<Command>

D	P	C		1	7	C _R
---	---	---	--	---	---	----------------

<Response>

O	K	C _R
---	---	----------------

ECHO or EEC

Returns as is any character string sent by an external device. Only single-byte alphanumerics can be used.

<Command format>

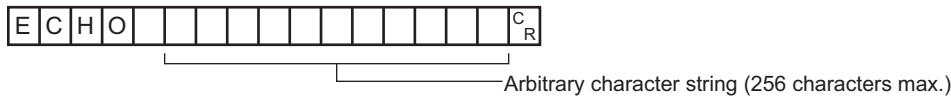

or

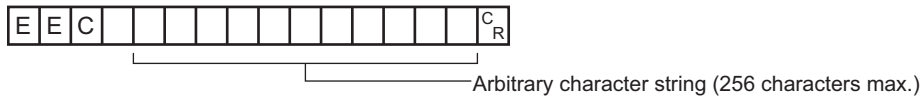

<Response format>

When processing is performed normally

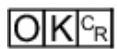
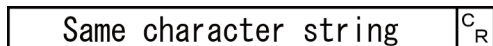

When processing is not performed normally



<Parameters explanation>

Arbitrary character string	Sets the character string returned as is. The response is the character string set here as is.
----------------------------	--

(Example)

When returning the character string "TEST"

<Command>



<Response>

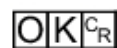

IMAGECAPTURE or EIC

Captures the screen. The folder into which the captured image is saved depends on the system data setting. The file name depends on the argument.

- No argument: Time stamp (Reference: ► *Capturing Screen Images in the Vision System FH/FZ5 Series User's Manual (Cat. No. Z365)*)
- Argument: Saves with the file name in the argument. If the file name extension is other than ".bmp", then ".bmp" is added to the file name.

<Command format>

No argument

```
I M A G E C A P T U R E CR
```

or

```
E I C CR
```

With argument

```
I M A G E C A P T U R E [ ] CR
                        |
                        |----- File name (256 characters max.)
```

or

```
E I C [ ] CR
          |
          |----- File name (256 characters max.)
```

<Response format>

When processing is performed normally

```
O K CR
```

When processing is not performed normally

```
E R CR
```

<Parameters explanation>

File name	The folder name to save image data when image logging performs. Specify the folder name as an absolute path. The file name needs the "BMP" extension. The save destination to use differs by Sensor Controller model.		
	Save destination	FH series/FZ5-800 series/FZ5-1100 series/FZ5-1200 series ^{*1}	FZ5-L series/FZ5-600 series
	RAMDisk	C:\Data\RAMDisk	\RAMDISK
External memory	E:\, F:\, G:\, H:\, M:\ (FH series only)	\USBDisks to \USBDisks3	

*1: Do not specify a save destination other than RAMDisk or External memory, i.e. C:\ProgramFiles\FZ
The saved Scene data area may be reduced and the Sensor Controller will not perform correctly.

(Example)

When capturing an image to the file named "abc.bmp"

<Command>

E	I	C		¥	R	A	M	D		i	s	k	¥	a	b	c	.	b	m	p	C _R
---	---	---	--	---	---	---	---	---	--	---	---	---	---	---	---	---	---	---	---	---	----------------

<Response>

O	K	C _R
---	---	----------------

IMAGECAPTUREFOLDER or ICF

Getting the screen capture folder name

Gets the set screen capture folder name.

<Command format>

I|I|M|A|G|E|C|A|P|T|U|R|E|F|O|L|D|E|R|^C|_R

or

I|C|F|^C|_R

<Response format>

When processing is performed normally

S|c|r|e|e|n| |c|a|p|t|u|r|e| |f|o|l|d|e|r| |n|a|m|e|^C|_R

O|K|^C|_R

When processing is not performed normally

E|R|^C|_R

<Parameters explanation>

Screen capture folder name	Responds with the name of the folder that the screen capture is saved to with its absolute path.
----------------------------	--

(Example)

When the screen capture save destination is set to "RAMDisk"

<Command>

I|C|F|^C|_R

<Response>

¥|R|A|M|D|i|s|k|¥|^C|_R

O|K|^C|_R

Setting the screen capture folder name

Sets the screen capture folder name.

<Command format>



or

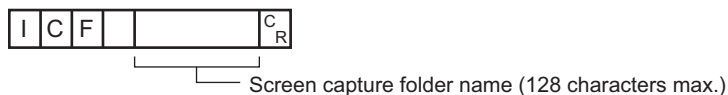

<Response format>

When processing is performed normally

OK^{C_R}

When processing is not performed normally

ER^{C_R}

<Parameters explanation>

Screen capture folder name	The folder name to save image data when image capture performs. Specify the folder name as an absolute path. The save destination to use differs by Sensor Controller model.		
	Save destination	FH series/FZ5-800 series/FZ5-1100 series/FZ5-1200 series ^{*1}	FZ5-L series/FZ5-600 series
	RAMDisk	C:\Data\RAMDisk	\RAMDISK
	External memory	E:\, F:\, G:\, H:\, M:\ (FH series only)	\USBdisk to \USBdisk3

*1: Do not specify a save destination other than RAMDisk or External memory, i.e. C:\ProgramFiles\FZ
The saved Scene data area may be reduced and the Sensor Controller will not perform correctly.

(Example)

When setting the screen capture folder name to "USBdisk"

<Command>

ICF ¥USBdisk ¥^{C_R}

<Response>

OK^{C_R}

IMAGEDISPCOND or IDC

Gets image mode

Gets the image mode for the specified Image Display window.

<Command format>

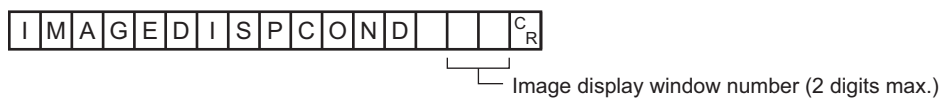

or

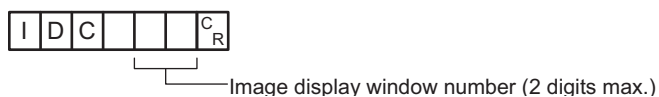

<Response format>

When processing is performed normally

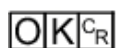
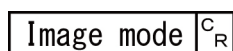

When processing is not performed normally



<Parameters explanation>

Image display window number	Image display window number (0 to 23)
Image mode	0: Through 1: Freeze or Freeze and Last NG together 2: Last NG

(Example)

When getting the image mode of the image display window 1 (through)

<Command>



<Response>



Sets image mode

Sets the image mode for the specified Image Display window.

<Command format>

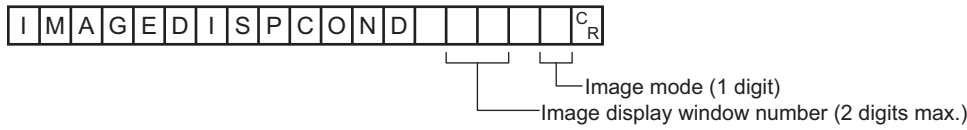

or



<Response format>

When processing is performed normally

OK C_R

When processing is not performed normally

ER C_R

<Parameters explanation>

Image display window number	Image display window number (0 to 23)
Image mode	0: Through 1: Freeze or Freeze and Last NG together 2: Last NG

(Example)

When setting "Last NG" for the image mode for the image display window 1

<Command>

I D C [] 1 [] 2 C_R

<Response>

OK C_R

IMAGEFIT or EIF

Returns the display position and display zoom ratio for the image display window to their default values.

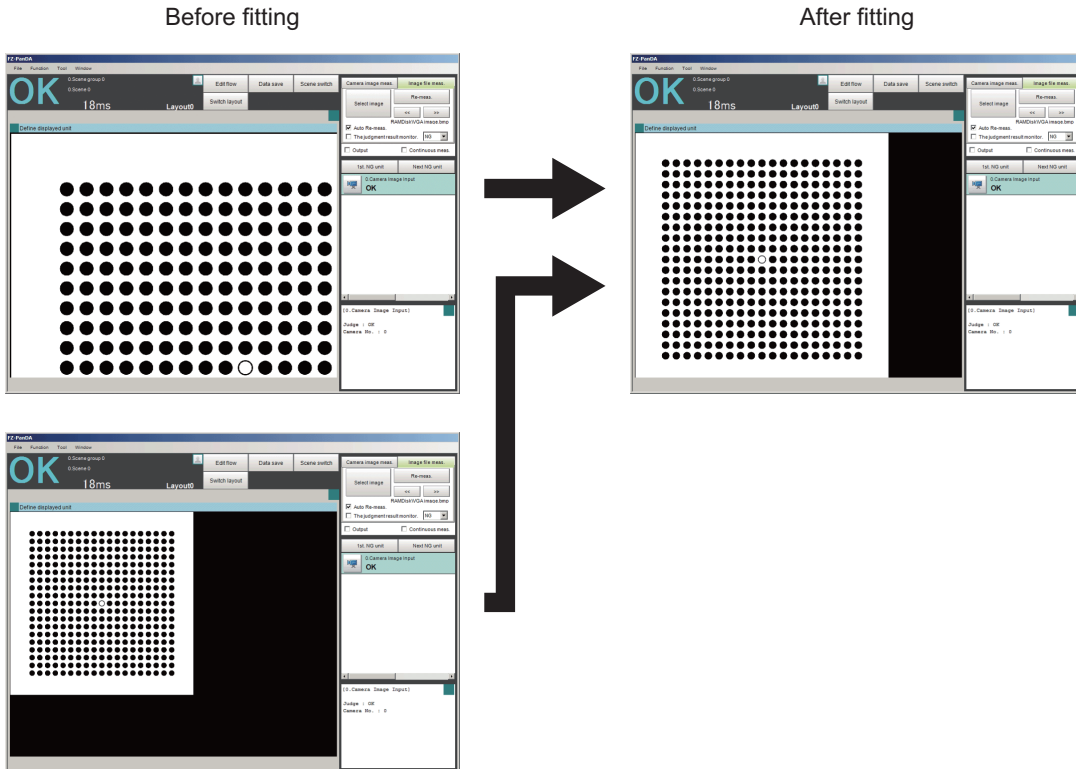

<Command format>

I M A G E F I T C R

Image display window number (2 digits max.)

or

E I F C R

Image display window number (2 digits max.)

<Response format>

When processing is performed normally

OK^{CR}

When processing is not performed normally

ER^{CR}

<Parameters explanation>

Image display window number	Image display window number (0 to 23) with the display position and display magnification returned to their default values.
-----------------------------	---

(Example)

When returning the display position and display zoom ratio for the image display window "1" to their default values

<Command>

E I F 1 ^C_R

<Response>

OK ^C_R

IMAGELOGFOLDER or ILF

Getting the image logging folder name

Gets the set image logging folder name.

<Command format>

IMAGELOGFOLDER^{C_R}

or

ILF^{C_R}

<Response format>

When processing is performed normally

Image logging folder name^{C_R}

OK^{C_R}

When processing is not performed normally

ER^{C_R}

<Parameters explanation>

Image logging folder name	Responds with the name of the folder the logging image is saved to with its absolute path.
---------------------------	--

(Example)

When the image logging save destination is set to "RAMDisk"

<Command>

ILF^{C_R}

<Response>

¥RAMDisk¥^{C_R}

OK^{C_R}

Setting the image logging folder name

Sets the image logging folder name.

<Command format>

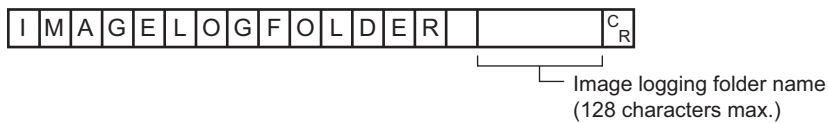

or

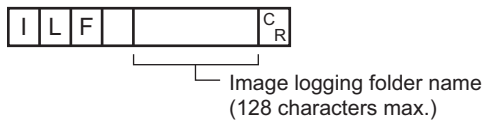

<Response format>

When processing is performed normally

OK^{CR}

When processing is not performed normally

ER^{CR}

<Parameters explanation>

Image Logging folder name	The folder name to save image data when image logging performs. Specify the folder name as an absolute path. The save destination to use differs by Sensor Controller model.		
	Save destination	FH series/FZ5-800 series/FZ5-1100 series/FZ5-1200 series ^{*1}	FZ5-L series/FZ5-600 series
	RAMDisk	C:\Data\RAMDisk	\RAMDISK
	External memory	E:\, F:\, G:\, H:\, M:\ (FH series only)	\USBdisk to \USBdisk3

*1: Do not make the Save destination in a folder other than RAMDisk, or external memory. Do not use (C:\ProgramFiles\FZ, etc.). The saved Scene data area may be reduced and the Sensor Controller will not perform correctly.

(Example)

When setting the image logging folder name to "USBdisk"

<Command>

ILF ¥USBdisk ¥^{CR}

<Response>

OK^{CR}

IMAGELOGHEADER or ILH

Getting the prefix for the name of the file the image logging is saved to

Gets the prefix for the name of the file the image logging is saved to. The maximum length of the prefix character string is 32 characters.

<Command format>

I M A G E L O G H E A D E R ^{C_R}

or

I L H ^{C_R}

<Response format>

When processing is performed normally

Image logging prefix ^{C_R}

OK ^{C_R}

When processing is not performed normally

ER ^{C_R}

<Parameters explanation>

Image logging prefix	Responds with the prefix for the name of the file the image logging is saved to.
----------------------	--

(Example)

When the prefix for the name of the file the image logging is saved to is set to "abc"

<Command>

I L H ^{C_R}

<Response>

a b c ^{C_R}

OK ^{C_R}

Setting the prefix for the name of the file the image logging is saved to

Sets the prefix for the name of the file the image logging is saved to. The maximum length of the prefix character string is 32 characters.

<Command format>

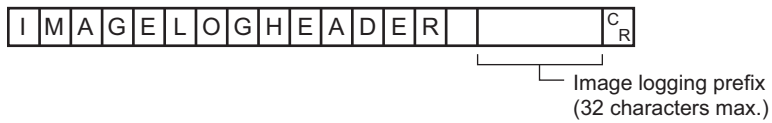

or



<Response format>

When processing is performed normally

OK_{C_R}

When processing is not performed normally

ER_{C_R}

<Parameters explanation>

Image logging prefix	Sets the prefix for the name of the file the image logging is saved to (with a maximum of 32 characters). The set character string is added at the beginning of the name of the save file.
----------------------	---

(Example)

When setting "abc" as the prefix for the name of the file the image logging is saved to

<Command>

I L H a b c C_R

<Response>

OK_{C_R}

IMAGESCROLL or EIS

The image display window whose number is specified is moved the specified distance in parallel. The setting range for the movement distance is not restricted. Also, because the scale for movement is independent of the display zoom ratio, the movement is not affected by change in the zoom ratio.

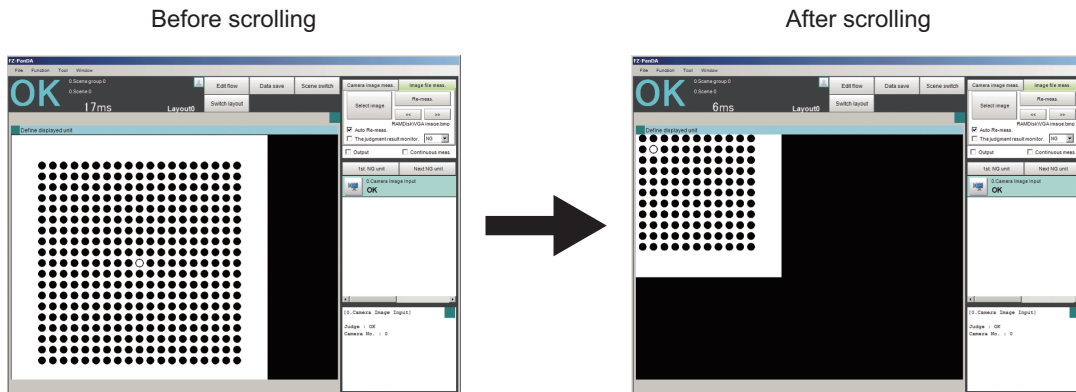

<Command format>

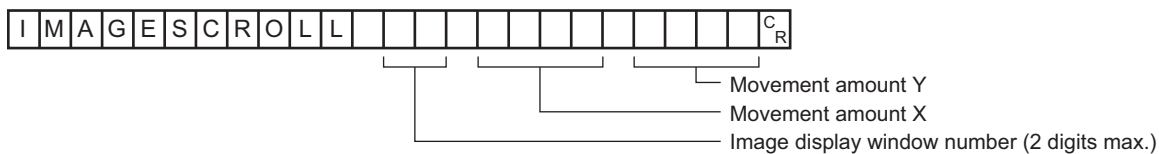

or

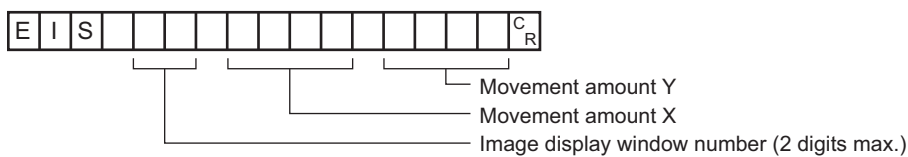

<Response format>

When processing is performed normally

OK^{CR}

When processing is not performed normally

ER^{CR}

<Parameters explanation>

Image display window number	Image display window number (0 to 23) with the display position and display magnification returned to their default values.
Movement amount X	Sets the X-direction movement distance (camera coordinate system).
Movement amount Y	Sets the Y-direction movement distance (camera coordinate system).

(Example)

When moving the image display window "1" image in parallel "20" in the X direction and "10" in the Y direction

<Command>

E	I	S		1		2	0		1	0	C _R
---	---	---	--	---	--	---	---	--	---	---	----------------

<Response>

O	K	C _R
---	---	----------------

IMAGESUBNO or ISN

Getting the number of the currently displayed sub-image.

Gets the number of the sub-image currently displayed in the specified image display window.

<Command format>

I M A G E S U B N O ^{C_R}

Image display window number (2 digits max.)

or

I S N ^{C_R}

Image display window number (2 digits max.)

<Response format>

When processing is performed normally

Sub image number ^{C_R}

OK ^{C_R}

When processing is not performed normally

ER ^{C_R}

<Parameters explanation>

Image display window number	Image display window number (0 to 23) for which to acquire the Image mode.
Sub image number	Responds with the number of the sub-image displayed in the current image display window.

(Example)

When getting the number of the sub-image being displayed in image display window "1"

<Command>

I S N 1 ^{C_R}

<Response>

0 ^{C_R}

OK ^{C_R}

Setting the number of the displayed unit

Sets the number of the unit displayed in the specified image display window.

<Command format>

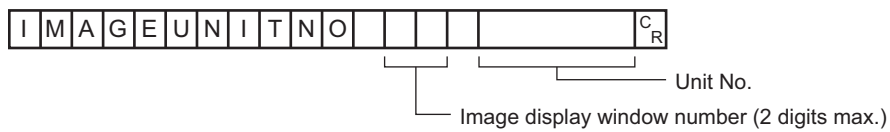

or

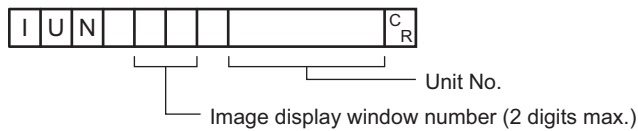

<Response format>

When processing is performed normally

OK^{C_R}

When processing is not performed normally

ER^{C_R}

<Parameters explanation>

Image display window number	Image display window number (0 to 23) for to set the Unit No.
Unit No.	Sets the number (0 to number of units in current scene -1) of the unit displayed in the image display window.

(Example)

When setting "2" as the number of the unit displayed in image display window "1"

<Command>

IUN 1 2^{C_R}

<Response>

OK^{C_R}

<Parameters explanation>

Image display window number	Image display window number (0 to 23) with the display position and display magnification returned to their default values.
Magnification	Sets the zoom ratio (250-16000). 250 means 25%; 16000 means 1600%.

(Example)

When zooming in image display window "1" to 200%

<Command>

E I Z 1 2000 C_R

<Response>

OK C_R

IMGSAVE

Saves image data.

<Command format>



<Response format>

When processing is performed normally

OK^{CR}

When processing is not performed normally

ER^{CR}

<Parameters explanation>

Image data No.	Specifies the No. of the image data to be saved (0 to max. number of logging images (I_MAX)).* ¹ The maximum number of logging images can be a number with a maximum of 3 digits. The number of images will vary depending on the Sensor Controller used and the camera connected. The image data number of the latest image is 0. Refer to ► <i>About Number of Logged Images</i> in the <i>Vision System FH/FZ5 Series User's Manual</i> (Cat. No. Z365)		
Destination folder name	The folder name to save image data. Specify the folder name as an absolute path. The file name needs the "IFZ" extension. The save destination to use differs by Sensor Controller model.		
	Save destination	FH series/FZ5-800 series/FZ5-1100 series/FZ5-1200 series*²	FZ5-L series/FZ5-600 series
	RAMDisk	C:\Data\RAMDisk	\RAMDISK
	External memory	E:\, F:\, G:\, H:\, M:\ (FH series only)	\USBdisk to \USBdisk3

*1: The maximum number of images that can be logged depends on the model of the Sensor Controller that you use and the models and number of connected Cameras. For details, refer to ► *Number of Logged Images* in the *Vision System FH/FZ5 Series User's Manual* (Cat. No. Z365) for the maximum number of images that can be logged (I_MAX).

*2: Do not specify a save destination other than RAMDisk or External memory, i.e. C:\ProgramFiles\FZ
The saved Scene data area may be reduced and the Sensor Controller will not perform correctly.

IMPORTANT

- If the specified file name already exists, this existing file will be overwritten
- Do not turn off power to the Sensor Controller until there is a response.

(Example)

When you save the following case:

- Number of image data: 3
- File name: LABEL1.IFZ
- Drive name: USBDisk2
- Folder name of the external memory: IMG01

<Command>

```
IMGSAVE 3 ¥USBDisk2¥IMG01¥LABEL1.IFZ CR
```

<Response>

```
OK CR
```

INPUTTRANSSTATE or ITS

Getting communication module input states

Gets the input state (permitted/prohibited) for communication modules.

<Command format>

INPUTTRANSSTATE ^{C_R}

Communication module types
(1 digit)

or

ITS ^{C_R}

Communication module types
(1 digit)

<Response format>

When processing is performed normally

Input state ^{C_R}

OK ^{C_R}

When processing is not performed normally

ER ^{C_R}

<Parameters explanation>

Communication module types	0: Serial (Ethernet) 1: Serial (RS-232C/422) 2: Parallel IO 3: Fieldbus 4: Remote operation
Input state	0: Prohibited 1: Permitted

(Example)

Getting the input status when serial (Ethernet) inputs are enabled (= 1)

<Command>

ITS 0 ^{C_R}

<Response>

1 ^{C_R}

OK ^{C_R}

Setting communication module input states

Permits/prohibits input to communication modules.

Any communication module whose input state is set to Prohibit (0) accepts no communications whatsoever. However, inputs related to hardware (parallel STEP signals/DSA signals and ECAT STEP, etc.) are not included in the prohibition.

<Command format>

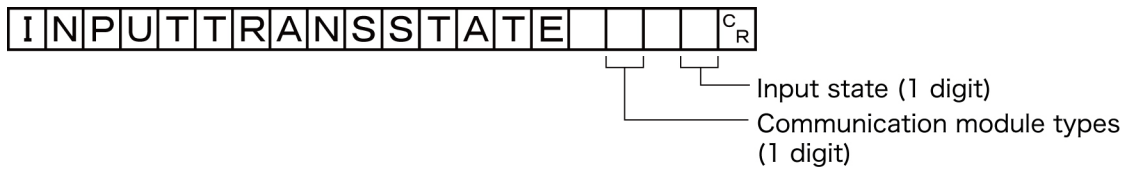

or

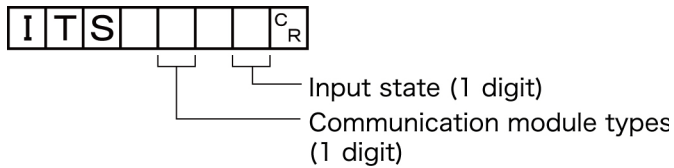

<Response format>

When processing is performed normally

OK^C_R

When processing is not performed normally

ER^C_R

(Example)

Setting the serial (RS-232C/422) input state to prohibited

<Command>

ITS 1 0^C_R

<Response>

OK^C_R

LASTIMAGESAVE or LIS

Executes a save of the last input image. The character string handed over by the argument is used as the file name.

<Command format>

LASTIMAGESAVE [] []^{C_R}
 File name (max. 256 digits)

or

LIS [] []^{C_R}
 File name (max. 256 digits)

<Response format>

When processing is performed normally

OK^{C_R}

When processing is not performed normally

ER^{C_R}

<Parameters explanation>

File name	The folder name to save image data. Specify the folder name as an absolute path. The save destination differs by Sensor Controller model.		
	Save destination	FH series/FZ5-800 series/FZ5-1100 series/FZ5-1200 series ^{*1}	FZ5-L series/FZ5-600 series
	RAMDisk	C:\Data\RAMDisk	\RAMDISK
External memory	E:\, F:\, G:\, H:\, M:\ (FH series only)	\USBdisk to \USBdisk3	

*1: Do not make the Save destination in a folder other than RAMDisk, or external memory. Do not use (C:\ProgramFiles\FZ, etc.). The saved Scene data area may be reduced and the Sensor Controller will not perform correctly.

(Example)

When saving the last input image to the file named "abc.ifz".

<Command>

LIS ¥RAMDisk¥abc.ifz^{C_R}

<Response>

OK^{C_R}

Note

- When the extension is ".ifz", the image is saved with the specified file name.
- When the extension is anything other than ".ifz", the image is saved with ".ifz" appended to the file name.
- If there is no extension (only the folder name is given), the image is saved to a file named time stamp ".ifz".

LAYOUTNO or DLN

Gets or sets the current layout number.

IMPORTANT

- For non-remote operation, only 0: Local can be specified. For remote operation, only 1: Remote can be specified. If any combination other than the above combinations is used, unexpected operation may occur when the command is executed.

Getting the layout number

Gets the number of the currently displayed layout.

<Command format>

LAYOUTNO ^{C_R}

Acquisition target

or

DLN ^{C_R}

Acquisition target

<Response format>

When processing is performed normally

Layout number ^{C_R}

OK ^{C_R}

When processing is not performed normally

ER ^{C_R}

<Parameters explanation>

Acquisition target	0: Local 1: Remote
Layout number	Current layout number (0 to 8)

(Example)

When the currently displayed window (local) is the RUN window

<Command>

DLN 0 ^{C_R}

<Response>

1 ^{C_R}

OK ^{C_R}

Setting the layout number

Sets the layout number and switches the window.

<Command format>

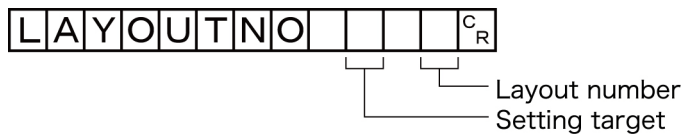

or

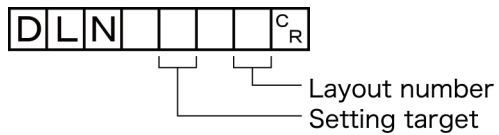

<Response format>

When processing is performed normally

OK^C_R

When processing is not performed normally

ER^C_R

(Example)

When displaying the RUN window (local)

<Command>

D L N 0 1^C_R

<Response>

OK^C_R

LOGINACCOUNT or LAI

Acquires the user name for the currently logged in user account

Gets the user ID for the currently logged in account.

<Command format>

LOGINACCOUNT

Acquisition target (1 digit)

or

LAI

Acquisition target (1 digit)

<Response format>

When processing is performed normally

User ID

OK

When processing is not performed normally

ER

<Parameters explanation>

Acquisition target	0: Local 1: Remote
User ID	Returns the user ID in the user account used by the user currently logging in.

(Example)

Getting the name of the user (abc) that is currently logged in (local)

<Command>

LAI

<Response>

abc

OK

Switching the currently logged in account

Switches the currently logged in account.

<Command format>

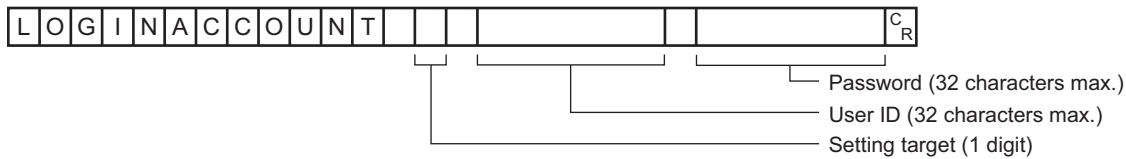

or

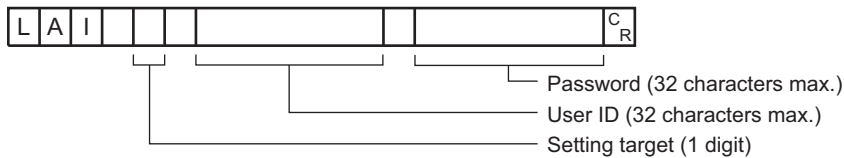

<Response format>

When processing is performed normally

OK^{CR}

When processing is not performed normally

ER^{CR}

<Parameters explanation>

Settable Objects	0: Local 1: Remote
User ID	Specify the ID for the user to switch (32 characters maximum).
Password	Specify the password for the user to switch (32 characters maximum).

(Example)

When switching to user ID "abc" with password "efg" (local)

<Command>

L A I 0 a b c e f g^{CR}

<Response>

OK^{CR}

LOGINACCOUNTGROUP or LAG

Gets the group ID in the user account used by the user currently logging in.

<Command format>

LOG I N A C C O U N T G R O U P ^{C_R}

Acquisition target (1 digit)

or

L A G ^{C_R}

Acquisition target (1 digit)

<Response format>

When processing is performed normally

Group ID ^{C_R}

OK ^{C_R}

When processing is not performed normally

ER ^{C_R}

<Parameters explanation>

Acquisition target	0: Local 1: Remote
Group ID	Returns the group ID in the user account used by the user currently logging in.

(Example)

The following sample command returns user group ID "UG1" in the user account used by the user currently logging in.

<Command>

L A G 0 ^{C_R}

<Response>

1 ^{C_R}

OK ^{C_R}

MEASURE or M

Executing measurement

Executes measurement one time.

<Command format>

MEASURE^{CR} or **M**^{CR}

<Response format>

When processing is performed normally

Non-procedure	Normal (Fxxx series)
<p>OK^{CR} Measurement result^{CR}</p>	<p>Measurement result^{CR} OK^{CR}</p>

When processing is not performed normally

ER^{CR}

Note

- About "Normal (Fxxx series method)"
Reference: ► Command Formats (p.289)

<Parameters explanation>

Measurement result	When "Data Output" is set in the flow, the measurement results are output. When "Data Output" is not set, the measurement results are not output. Reference: ► Output Format (p.296)
--------------------	--

Starts continuous measurement

Starts continuous measurement.

<Command format>

MEASURE / **C**^{CR}

<Response format>

When processing is performed normally

OK^{CR}
Measurement result^{CR}
Measurement result^{CR}
Measurement result^{CR}

— Continuous measurement count

When processing is not performed normally

ER^{C_R}

<Parameters explanation>

Measurement result	The measurement results from the number of times continuous measurement is performed are output as a response. Reference: ► Output Format (p.296)
--------------------	--

Completes continuous measurement

Continuous measurement ends.

<Command format>

MEASURE / **E**^{C_R}

<Response format>

When processing is performed normally

OK^{C_R}

When processing is not performed normally

ER^{C_R}

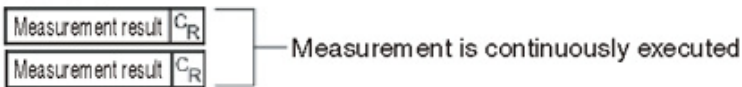

Note

- To output measurement results, insert a [Data Output] processing unit in the scene. When the scene does not have a [Data Output] processing unit, only a command response is output.
Reference: ► Output Format (p.296)
Reference: ► Output Data Settings (Processing Item Registration) (p.184), (p.279)

MEASUREUNIT or MTU

Performs a test measurement on the specified unit.

<Command format>

MEASUREUNIT []^{C_R}
Unit No.

or

MTU []^{C_R}
Unit No.

<Response format>

When processing is performed normally

OK^{C_R}

When processing is not performed normally

ER^{C_R}

<Parameters explanation>

Unit No.	Specifies the unit number to run a test with: 0 to the uppermost unit model number in the scene.
----------	--

(Example)

The following sample command runs a test on unit number 5:

<Command>

MTU 5^{C_R}

<Response>

OK^{C_R}

OPELOGCOND or OLC

Gets logging operation state

Gets the logging operation state.

<Command format>

OPELOGCOND^{C_R}

or

OLC^{C_R}

<Response format>

When processing is performed normally

Logging operation state^{C_R}

OK^{C_R}

When processing is not performed normally

ER^{C_R}

<Parameters explanation>

Logging operation state	0: OFF 1: ON
-------------------------	-----------------

(Example)

The following sample command returns an enabled logging operation state:

<Command>

OLC^{C_R}

<Response>

1^{C_R}

OK^{C_R}

Sets logged operation state

Sets the logged operation state. This command allows configuring the logging operation state in the same manner as for the Start/End Logging Operation buttons on the Main screen.

<Command format>

O	P	E	L	O	G	C	O	N	D			^C _R
---	---	---	---	---	---	---	---	---	---	--	--	---------------------------

└─── Logging operation state (1 digit)

or

O	L	C			^C _R
---	---	---	--	--	---------------------------

└─── Logging operation state (1 digit)

<Response format>

When processing is performed normally

O	K	^C _R
---	---	---------------------------

When processing is not performed normally

E	R	^C _R
---	---	---------------------------

(Example)

The following sample command enables the logging operation state.

<Command>

O	L	C	1	^C _R
---	---	---	---	---------------------------

<Response>

O	K	^C _R
---	---	---------------------------

OUTPUTTRANSSTATE or OTS

Gets output state to external device

Gets the output state to an external device: Enabled or Disabled:

<Command format>

OUTPUTTRANSSTATE^{C_R}

or

OTS^{C_R}

<Response format>

When processing is performed normally

Output state^{C_R}

OK^{C_R}

When processing is not performed normally

ER^{C_R}

<Parameters explanation>

Output state	0: Prohibited 1: Permitted
--------------	-------------------------------

(Example)

The following sample command retrieves the output state, Enabled:

<Command>

OTS^{C_R}

<Response>

1^{C_R}

OK^{C_R}

Sets the output state to external device

Permits/prohibits output to external devices

When the input state is disabled, i.e., set to (0), all the communications modules are unable to transmit data.

<Command format>



or

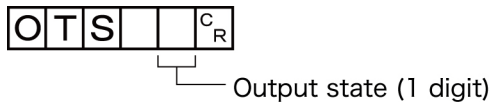

<Response format>

When processing is performed normally

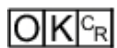

When processing is not performed normally



(Example)

Setting the output status to external devices to prohibited or prohibiting output to external devices

<Command>



<Response>

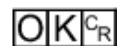

PARAALLCOND or PAC

Gets all parallel terminal states at once, except for DI terminals

Gets the ON/OFF states of all parallel terminals at once, except for DI terminals.

For how to set, refer to the following contents or example.

Example) When you want to set the parallel terminal status of Line 0 except DO to turn ON at once.

1. Sends the get command the parallel terminal status at once to the port number which set on the Line 0.
2. The parallel terminal status except DI is responded.

<Command format>

PARAALLCOND^{C_R}

or

PAC^{C_R}

<Response format>

When processing is performed normally

Terminal state^{C_R}

OK^{C_R}

When processing is not performed normally

ER^{C_R}

<Parameters explanation>

Terminal state	Terminal status 0: OFF 1: ON For assigned terminal to each bit, refer to *1.
----------------	---

*1: Assigned terminal to each bit
 FH-1000 series/FH-3000 series Sensor Controller

Supported bit	Terminal							
	Line 0	Line 1	Line 2	Line 3	Line 4	Line 5	Line 6	Line 7
BIT0	STEP0	STEP1	STEP2	STEP3	STEP4	STEP5	STEP6	STEP7
BIT1	DSA0	DSA1	0	0	0	0	0	0
BIT2	DILINE0	DILINE0	DILINE0	DILINE0	DILINE0	DILINE0	DILINE0	DILINE0
BIT3	DILINE1	DILINE1	DILINE1	DILINE1	DILINE1	DILINE1	DILINE1	DILINE1
BIT4	DILINE2	DILINE2	DILINE2	DILINE2	DILINE2	DILINE2	DILINE2	DILINE2
BIT5	0	0	0	0	0	0	0	0
BIT6	0	0	0	0	0	0	0	0
BIT7	0	0	0	0	0	0	0	0
BIT8	0	0	0	0	0	0	0	0
BIT9	0	0	0	0	0	0	0	0
BIT10	0	0	0	0	0	0	0	0
BIT11	0	0	0	0	0	0	0	0
BIT12	0	0	0	0	0	0	0	0
BIT13	0	0	0	0	0	0	0	0
BIT14	0	0	0	0	0	0	0	0
BIT15	0	0	0	0	0	0	0	0

FH-L series Sensor Controller

Supported bit	Terminal
	Line 0
BIT0	STEP0
BIT1	DSA0
BIT2	0
BIT3	0
BIT4	0
BIT5	0
BIT6	0
BIT7	0
BIT8	0
BIT9	0
BIT10	0
BIT11	0
BIT12	0
BIT13	0
BIT14	0
BIT15	0

FZ5-800/FZ5-1100/FZ5-1200 series Sensor Controller

Supported bit	Terminal	
	Line 0	Line 1
BIT0	STEP0	STEP0
BIT1	STEP1	STEP1
BIT2	DSA0	DSA0
BIT3	DSA1	DSA1
BIT4	0	0
BIT5	0	0
BIT6	0	0
BIT7	0	0
BIT8	0	0
BIT9	0	0
BIT10	0	0
BIT11	0	0
BIT12	0	0
BIT13	0	0
BIT14	0	0
BIT15	0	0

FZ5-L/FZ5-600 series Sensor Controller

Supported bit	Terminal
	Line 0
BIT0	STEP0
BIT1	0
BIT2	DSA0
BIT3	0
BIT4	0
BIT5	0
BIT6	0
BIT7	0
BIT8	0
BIT9	0
BIT10	0
BIT11	0
BIT12	0
BIT13	0
BIT14	0
BIT15	0

IMPORTANT

- When the Multi-line Random Trigger mode is selected in the following series, usable signal type or assignment are differ depending on the used number of Lines.
 - FH-1000 series
 - FH-3000 series
 - FZ5-800 series
 - FZ5-1100 series
 - FZ5-1200 series

Sending commands to the port number which assigned each Lines, acquisition of desired terminal status can be enable. For more details of Operation mode, refer to ► Multi-line Random Trigger Mode Signal Specifications (p.325).

- Regarding the common signal of all lines, you can acquire the terminal status regardless using Line number. Confirm the changing of the acquired data by adjusting the actual parallel terminal status.

(Example)

The following sample command returns the state of enabled STEP0 and DSA1:

<Command>

PAC^{C_R}

<Response>

9^{C_R}

OK^{C_R}

The response of 1001 (binary) is given as 9 (decimal).

Sets all parallel terminal states at once, except for DO terminals

Sets the ON/OFF status of all Parallel terminals except for DO terminals.

For how to set, refer to the following:

Example)

When you wish to set all parallel terminal states other than DO of line 0 to ON

1. Sets the Parallel terminal assignment BIT status, for the parallel terminals other than the DO you want to set, to ON.
2. Send the specified command which set step 1 to the port number of Line 0.
3. Executed result of command is responded.

<Command format>

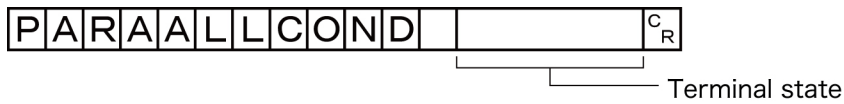

or

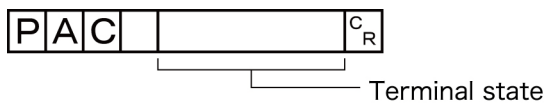

<Response format>

When processing is performed normally



When processing is not performed normally



<Parameters explanation>

Terminal state	Terminal status 0: OFF 1: ON For assigned terminal to each bit, refer to *1.
----------------	---

*1: Assigned terminal to each bit
 FH-1000 series/FH-3000 series Sensor Controller

Supported bit	Terminal							
	Line 0	Line 1	Line 2	Line 3	Line 4	Line 5	Line 6	Line 7
BIT0	RUN0	RUN1	RUN2	RUN3	-	-	-	-
BIT1	ERROR/ ERROR0	ERROR1	ERROR2	ERROR3	ERROR	ERROR	ERROR	ERROR
BIT2	BUSY0	BUSY1	BUSY2	BUSY3	BUSY4	BUSY5	BUSY6	BUSY7
BIT3	OR0	OR1	OR2	OR3	OR4	OR5	OR6	OR7
BIT4	GATE0	GATE1	-	-	-	-	-	-
BIT5	READY0	READY1	READY2	READY3	READY4	READY5	READY6	READY7
BIT6	ACK	ACK	ACK	ACK	ACK	ACK	ACK	ACK
BIT7	-	-	-	-	-	-	-	-
BIT8	-	-	-	-	-	-	-	-
BIT9	-	-	-	-	-	-	-	-
BIT10	-	-	-	-	-	-	-	-
BIT11	-	-	-	-	-	-	-	-
BIT12	-	-	-	-	-	-	-	-
BIT13	-	-	-	-	-	-	-	-
BIT14	-	-	-	-	-	-	-	-
BIT15	-	-	-	-	-	-	-	-

FH-L series Sensor Controller

Supported bit	Terminal
	Line 0
BIT0	RUN
BIT1	ERROR
BIT2	BUSY
BIT3	OR0
BIT4	GATE0
BIT5	READY0
BIT6	ACK
BIT7	-
BIT8	-
BIT9	-
BIT10	-
BIT11	-
BIT12	-
BIT13	-
BIT14	-
BIT15	-

FZ5-800/FZ5-1100/FZ5-1200 series Sensor Controller

Supported bit	Terminal	
	Line 0	Line 1
BIT0	RUN	BUSY1
BIT1	ERROR	ERROR
BIT2	BUSY	BUSY0
BIT3	OR0	OR0
BIT4	OR1	OR1
BIT5	GATE0	GATE0
BIT6	GATE1	GATE1
BIT7	READY0	READY0
BIT8	READY1	READY1
BIT9	-	-
BIT10	-	-
BIT11	-	-
BIT12	-	-
BIT13	-	-
BIT14	-	-
BIT15	-	-

FZ5-L/FZ5-600 series Sensor Controller

Supported bit	Terminal
	Line 0
BIT0	RUN
BIT1	ERROR
BIT2	BUSY
BIT3	OR0
BIT4	-
BIT5	GATE0
BIT6	-
BIT7	READY0
BIT8	-
BIT9	-
BIT10	-
BIT11	-
BIT12	-
BIT13	-
BIT14	-
BIT15	-

IMPORTANT

- When the Multi-line Random Trigger mode is selected in the following series, usable signal type or assignment are differ depending on the used number of Lines.
 - FH-1000 series
 - FH-3000 series
 - FZ5-800 series
 - FZ5-1100 series
 - FZ5-1200 series

For more details of Operation mode, refer to ► Multi-line Random Trigger Mode Signal Specifications (p.325).

- Sending this command to the each lines assigned port number, can set the specified terminal status.
When you set the unusable or different terminal status of lines, the response code is OK and the status is be disposed.
Confirm the change of the parallel terminal status by changing the set data.

(Example)

The following sample command activates RUN:

<Command>

P A C 1 ^{C_R}

<Response>

OK ^{C_R}

PARAPORTCOND or PPC

Gets the specified status of parallel I/O

Gets the ON/OFF information of specified parallel I/O terminal.

Specify the parallel terminal with combination of terminal type and terminal number.

For how to set, refer to the following:

Example)

When you want to get the terminal status of STEP0 and Line0

1. Set [0] in terminal type, [STEP] is specified.
2. Set [0] in terminal number, [STEP0] of [Line0] are specified.
3. Sends the specified command which set the above step 1 and 2 to the port number of Line 0.
4. Responds the specified terminal status.

<Command format>

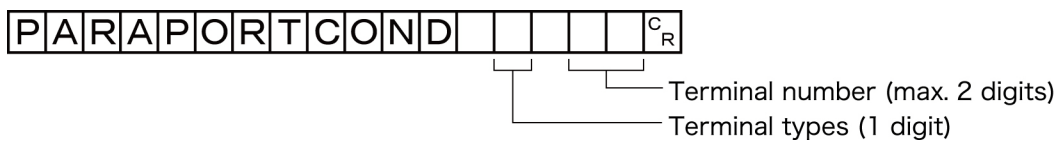

or

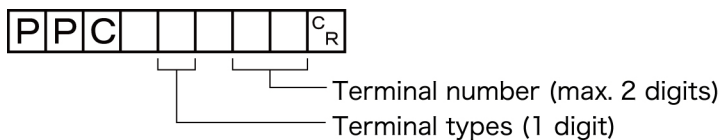

<Response format>

When processing is performed normally

Terminal state^{CR}

OK^{CR}

When processing is not performed normally

ER^{CR}

<Parameters explanation>

Terminal type	Set the terminal by combining Terminal number. Specified terminal differ according to the Sensor Controller series. For detail, refer to *1.
Terminal number	Set the terminal by combining Terminal type. Specified terminal differ according to the Sensor Controller series. For detail, refer to *1.
Terminal state	0: OFF 1: ON

*1: Terminal type and Terminal number
FH-1000 series/FH-3000 series Sensor Controller

Terminal type		Terminal number							
		0	1	2	3	4	5	6	7
STEP	0	STEP0	STEP1	STEP2	STEP3	STEP4	STEP5	STEP6	STEP7
DSA	1	DSA0	DSA1	-	-	-	-	-	-
DI	2	DI0	DI1	DI2	DI3	DI4	DI5	DI6	DI7
DI_LINE	11	DILINE0	DILINE1	DILINE2	-	-	-	-	-

Terminal type		Terminal number							
		0	1	2	3	4	5	6	7
STEP	0	STEP0	STEP1	-	-	-	-	-	-
DSA	1	DSA0	DSA1	-	-	-	-	-	-
DI	2	DI0	DI1	DI2	DI3	DI4	DI5	DI6	DI7
DI_LINE	11	-	-	-	-	-	-	-	-

Terminal type		Terminal number							
		0	1	2	3	4	5	6	7
STEP	0	STEP0	-	-	-	-	-	-	-
DSA	1	DSA0	-	-	-	-	-	-	-
DI	2	DI0	DI1	DI2	DI3	DI4	DI5	DI6	DI7
DI_LINE	11	-	-	-	-	-	-	-	-

IMPORTANT

- When the Multi-line Random Trigger mode is selected in the following series, usable signal type or assignment are differ depending on the used number of Lines.
 - FH-1000 series
 - FH-3000 series
 - FZ5-800 series
 - FZ5-1100 series
 - FZ5-1200 series

For more details of Operation mode, refer to ► Multi-line Random Trigger Mode Signal Specifications (p.325).

- This command gets the terminal status of each line by specifying its port number.
When getting the terminal status of an unusable line, the response code will be OK and the response data will always be 0.
Verify the received data by changing the actual parallel terminal status.

(Example)

The following sample command gets the state of STEP1:

<Command>

P P C 0 1 C_R

<Response>

1 C_R

OK C_R

Sets the state of specified parallel I/O terminal

Sets the specified parallel I/O terminal: ON/OFF

Specifies the Parallel terminal with a combination of terminal type, terminal number and terminal status.

For how to set, refer to the following contents or example.

Example)

When you want to set the parallel terminal status of Line 0 except DO to turn ON at once.

1. Sends the get command the parallel terminal status at once to the port number which set on the Line 0.
2. The parallel terminal status except DI is responded.

<Command format>

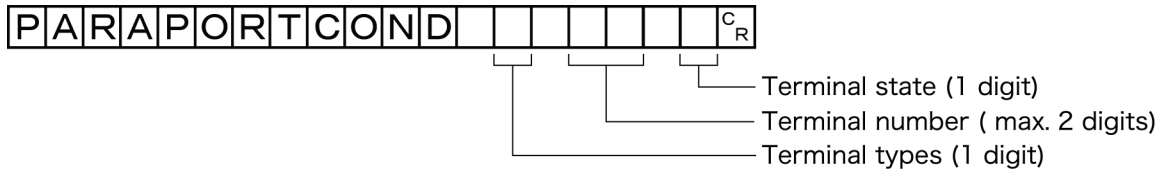

or

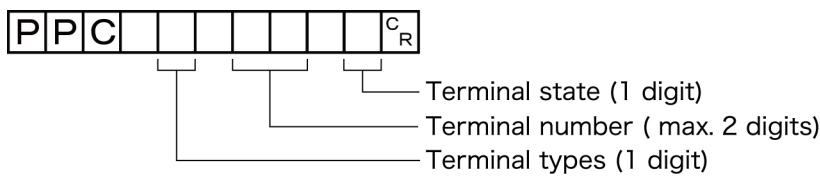

<Response format>

When processing is performed normally

OK^{CR}

When processing is not performed normally

ER^{CR}

<Parameters explanation>

Terminal types	Set the terminal by combining Terminal number. Specified terminal differ according to the Sensor Controller series. For detail, refer to *1.
Terminal number	Set the terminal by combining Terminal type. Specified terminal differ according to the Sensor Controller series. For detail, refer to *1.
Terminal state	0: OFF 1: ON

*1: Terminal type and terminal number
 FH-1000 series/FH-3000 series Sensor Controller

Terminal type	Terminal number	Terminal number															
		0	1	2	3	4	5	6	7	8	9	10	11	12	13	14	15
RUN	3	RUN0	RUN1	RUN2	RUN3	-	-	-	-	-	-	-	-	-	-	-	-
ERR	4	ERROR/ ERROR0	ERROR1	ERROR2	ERROR3	-	-	-	-	-	-	-	-	-	-	-	-
BUSY	5	BUSY0	BUSY1	BUSY2	BUSY3	BUSY4	BUSY5	BUSY6	BUSY7	-	-	-	-	-	-	-	-
OR	6	OR0	OR1	OR2	OR3	OR4	OR5	OR6	OR7	-	-	-	-	-	-	-	-
GATE	7	GATE0	GATE1	-	-	-	-	-	-	-	-	-	-	-	-	-	-
READY	8	READY0	READY1	READY2	READY3	READY4	READY5	READY6	READY7	-	-	-	-	-	-	-	-
DO	9	DO0	DO1	DO2	DO3	DO4	DO5	DO6	DO7	DO8	DO9	DO10	DO11	DO12	DO13	DO14	DO15
ACK	10	ACK	-	-	-	-	-	-	-	-	-	-	-	-	-	-	-

FZ5-800/FZ5-1100/FZ5-1200 series Sensor Controller

Terminal type	Terminal number	Terminal number															
		0	1	2	3	4	5	6	7	8	9	10	11	12	13	14	15
RUN	3	RUN/ BUSY1	-	-	-	-	-	-	-	-	-	-	-	-	-	-	-
ERR	4	ERROR	-	-	-	-	-	-	-	-	-	-	-	-	-	-	-
BUSY	5	BUSY0	-	-	-	-	-	-	-	-	-	-	-	-	-	-	-
OR	6	OR0	OR1	-	-	-	-	-	-	-	-	-	-	-	-	-	-
GATE	7	GATE0	GATE1	-	-	-	-	-	-	-	-	-	-	-	-	-	-
READY	8	READY0	READY1	-	-	-	-	-	-	-	-	-	-	-	-	-	-
DO	9	DO0	DO1	DO2	DO3	DO4	DO5	DO6	DO7	DO8	DO9	DO10	DO11	DO12	DO13	DO14	DO15
ACK	10	-	-	-	-	-	-	-	-	-	-	-	-	-	-	-	-

FH-L series/FZ5-L series/FZ5-600 series Sensor Controller

Terminal type	Terminal number	Terminal number															
		0	1	2	3	4	5	6	7	8	9	10	11	12	13	14	15
RUN	3	RUN	-	-	-	-	-	-	-	-	-	-	-	-	-	-	-
ERR	4	ERROR	-	-	-	-	-	-	-	-	-	-	-	-	-	-	-
BUSY	5	BUSY0	-	-	-	-	-	-	-	-	-	-	-	-	-	-	-
OR	6	OR0	-	-	-	-	-	-	-	-	-	-	-	-	-	-	-
GATE	7	GATE0	-	-	-	-	-	-	-	-	-	-	-	-	-	-	-
READY	8	READY0	-	-	-	-	-	-	-	-	-	-	-	-	-	-	-
DO	9	DO0	DO1	DO2	DO3	DO4	DO5	DO6	DO7	DO8	DO9	DO10	DO11	DO12	DO13	DO14	DO15
ACK	10	-	-	-	-	-	-	-	-	-	-	-	-	-	-	-	-

IMPORTANT

- When the Multi-line Random Trigger mode is selected in the following series, usable signal type or assignment are differ depending on the used number of Lines.
 - FH-1000 series
 - FH-3000 series
 - FZ5-800 series
 - FZ5-1100 series
 - FZ5-1200 series

For more details of Operation mode, refer to ► Multi-line Random Trigger Mode Signal Specifications (p.325).

- Sending this command to the each lines assigned port number, can set the specified terminal status.
When you set the unusable or different terminal status of lines, the response code is OK and the status is be disposed.
Confirm the change of the parallel terminal status by changing the set data.

(Example)

Setting READY0 to ON

<Command>

P	P	C	8	0	1	C _R
---	---	---	---	---	---	----------------

<Response>

O	K	C _R
---	---	----------------

REGIMAGE or RID

Registers specified image data as registered image

Registers the data of a specified image as a registered image. The status after the command is executed is the same as after the operation is executed for the Register Button in the Registered Image Manager. If the source to register is 0, the last measured image, command argument 3, can be omitted.

<Command format>

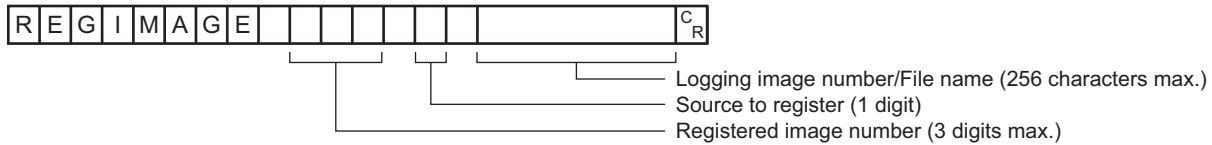

or

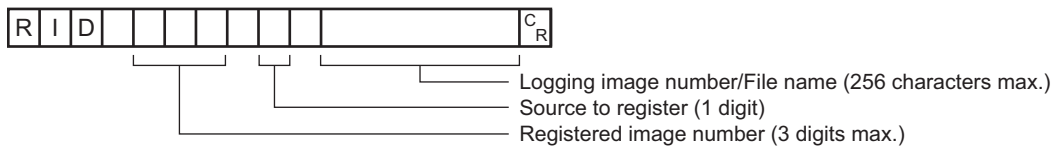

<Response format>

When processing is performed normally

OK_{C_R}

When processing is not performed normally

ER_{C_R}

<Parameters explanation>

Registered image number	Specifies the registered image number: 0 to 999.
Source to register	0: Last measured image 1: System logging image 2: Image file
Logging image number/ File name	If you have specified a system logging image as the source to register, specify a logging image number: 0 to the number of the logging system images -1. If you have specified an image file, specify a file name with 0 to 256 characters.

(Example)

When an image with registered image number "100" and logging image number "10" is registered

<Command>

R I D 1 0 0 1 1 0_{C_R}

<Response>

OK_{C_R}

IMPORTANT

- JPG(JFZ) format image files cannot be registered, or loaded.

Loads specified image data as registered image

Loads a specified registered image as a measured image. The status after the command is executed is the same as after the operation is executed for the Read Button in the Registered Image Manager.

<Command format>

REGIMAGE [] [] [] ^{C_R}

Registered image number (max. 3 digits)

or

RID [] [] [] ^{C_R}

Registered image number (max. 3 digits)

<Response format>

When processing is performed normally

OK^{C_R}

When processing is not performed normally

ER^{C_R}

<Parameters explanation>

Registered image number	Specifies the registered image number: 0 to 999.
-------------------------	--

(Example)

The following sample command loads the image with registered image number 100 as a measured image.

<Command>

RID 100^{C_R}

<Response>

OK^{C_R}

RESET

Restart the Sensor Controller.

<Command format>

RESET^{C_R}

<Response format>

None

SCENE or S

Acquires scene number

Acquires the current scene No.

<Command format>

SCENE^{CR} or **S^{CR}**

<Response format>

When processing is performed normally

^{CR}

Scene No. (3 digits max.)

OK^{CR}

When processing is not performed normally

ER^{CR}

<Parameters explanation>

Scene No.	The acquired scene No. (currently used scene No.) is output as a response (0 to 127).
-----------	---

(Example)

When scene 0 is being used

<Command>

SCENE^{CR}

<Response>

0^{CR}

OK^{CR}

Scene switch No.

Switches the scene number to be used.

<Command format>

S	C	E	N	E				C _R
---	---	---	---	---	--	--	--	----------------

Scene No. (3 digits max.)

<Response format>

When processing is performed normally

O	K	C _R
---	---	----------------

When processing is not performed normally

E	R	C _R
---	---	----------------

<Parameters explanation>

Scene No.	Specifies the scene No. after switching (0 to 127).
-----------	---

(Example)

When switching to scene 2

<Command>

S	C	E	N	E		2	C _R
---	---	---	---	---	--	---	----------------

<Response>

O	K	C _R
---	---	----------------

SCNGROUP or SG

Acquires scene group number

Acquires the current scene group No.

<Command format>

SCNGROUP^{CR} or **SG**^{CR}

<Response format>

When processing is performed normally

^{CR}

_____ Scene group No. (max. 2 digits)

OK^{CR}

When processing is not performed normally

ER^{CR}

<Parameters explanation>

Scene group No.	The acquired scene group No. (currently used scene group No.) is output as a response (0 to 31).
-----------------	--

(Example)

When scene group 0 is being used

<Command>

SCNGROUP^{CR}

<Response>

0^{CR}

OK^{CR}

Switches the scene group number

Switches the scene group number to be used.

<Command format>

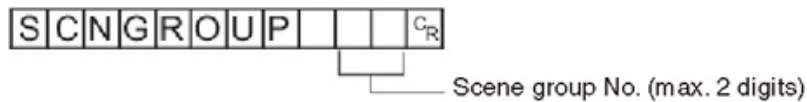

<Response format>

When processing is performed normally

OK C_R

When processing is not performed normally

ER C_R

<Parameters explanation>

Scene group No.	Specifies the scene group No. after switching (0 to 31).
-----------------	--

(Example)

When switching to scene group 2

<Command>

SCNNGROUP 2 C_R

<Response>

OK C_R

IMPORTANT

- During parallel continuous measurement and when the STEP signal is input continuously, do not perform switching of the scene group. When this is performed, set "Unchecked" in "Save scene group on switch scene" in either of the settings items below.
- Switch Scene Group window (Reference: ► *Changing the Scene or Scene Group* in the *Vision System FH/FZ5 Series User's Manual* (Cat. No. Z365))
- [Measure setting] in the [Measure] menu (Reference: ► *Setting the Conditions That Are Related to Operation during Measurement* in the *Vision System FH/FZ5 Series User's Manual* (Cat. No. Z365))

SCNLOAD

Reads scene data.

<Command format>

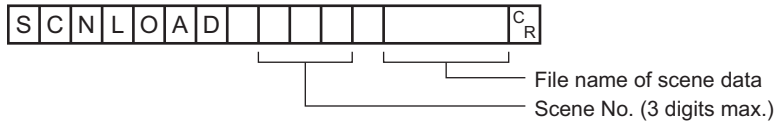

<Response format>

When processing is performed normally

OKC_R

When processing is not performed normally

ERC_R

<Parameters explanation>

Scene No.	Specifies the scene No. to be read (0 to 127)		
File name of scene data	The name of the file containing the Scene data you wish to load. Specify the file name as an absolute path. The file name needs the "SCN" extension. The file which has "SCN" extension can be load. The load destination to use differs by Sensor Controller model.		
	Load destination	FH series/FZ5-800 series/FZ5-1100 series FZ5-1200 series	FZ5-L series/FZ5-600 series
	RAMDisk	C:\Data\RAMDisk	\RAMDISK
	External memory	E:\, F:\, G:\, H:\, M:\ (FH series only)	\USBdisk to \USBdisk3

IMPORTANT

- Do not turn off power to the Sensor Controller until there is a response.

(Example)

When you load the following case to the Sensor Controller as Scene 2:

- SCNLOAD folder name: LABEL1.SCN
- Drive name: USBDisk2
- Folder name of the external memory: IMG01

<Command>

SCNLOAD | **2** | | \ USBDisk2 \ IMG01 \ LABEL1.SCN |C_R

<Response>

OKC_R

SCNSAVE

Saves scene data.

<Command format>

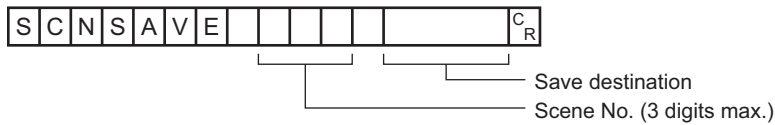

<Response format>

When processing is performed normally

OK C_R

When processing is not performed normally

ER C_R

<Parameters explanation>

Scene number	Specify the Scene number to save. (0 to 127)									
Destination	<p>The name of the file containing the Scene data you wish to save. Specify the file name as an absolute path. The file name needs the "SCN" extension. Save destination folder differ depending on the Sensor Controller series.</p> <table border="1"><thead><tr><th>Save destination</th><th>FH series/FZ5-800 series/FZ5-1100 series/FZ5-1200 series^{*1}</th><th>FZ5-L series/FZ5-600 series</th></tr></thead><tbody><tr><td>RAMDisk</td><td>C:\Data\RAMDisk</td><td>\RAMDISK</td></tr><tr><td>External memory</td><td>E:\, F:\, G:\, H:\, M:\ (FH series only)</td><td>\USBdisk to \USBdisk3</td></tr></tbody></table>	Save destination	FH series/FZ5-800 series/FZ5-1100 series/FZ5-1200 series ^{*1}	FZ5-L series/FZ5-600 series	RAMDisk	C:\Data\RAMDisk	\RAMDISK	External memory	E:\, F:\, G:\, H:\, M:\ (FH series only)	\USBdisk to \USBdisk3
Save destination	FH series/FZ5-800 series/FZ5-1100 series/FZ5-1200 series ^{*1}	FZ5-L series/FZ5-600 series								
RAMDisk	C:\Data\RAMDisk	\RAMDISK								
External memory	E:\, F:\, G:\, H:\, M:\ (FH series only)	\USBdisk to \USBdisk3								

*1: Do not make the Save destination in a folder other than RAMDisk, or external memory. Do not use (C:\ProgramFiles\FZ, etc.).
The saved Scene data area may be reduced and the Sensor Controller will not perform correctly.

IMPORTANT

- If the specified file name already exists, this existing file will be overwritten.
- Do not turn off power of the Sensor Controller until return the response.
- For the FH/FZ5-800/FZ5-1100/FZ5-1200 series, do not save to a non-volatile area on the C drive (such as C:\ProgramFiles\FZ). This would reduce the storage area for scene data etc. and make correct operation impossible.

(Example)

When you save the following case:

- Scene number: 3
- SCNSAVE file name: LABEL1.SCN
- Drive name: USBDisk2
- Folder name of the external memory: IMG01

<Command>

SCNSAVE | 3 | \ USBDisk2 \ IMG01 \ LABEL1.SCN C_R

<Response>

OK C_R

SGRLOAD

Reads scene group data.

<Command format>



<Response format>

When processing is performed normally

`OK` ^{CR}

When processing is not performed normally

`ER` ^{CR}

<Parameters explanation>

Scene group No.	Specifies the scene group No. to be read (0 to 31)		
File name of Scene group data	The name of the file containing the Scene group data you wish to load. Specify the file name as an absolute path. The file name needs the "SGP" extension. The file which has "SGP" extension can be load. The load destination to use differs by Sensor Controller model.		
	Load destination	FH series/FZ5-800 series/FZ5-1100 series/FZ5-1200 series	FZ5-L series/FZ5-600 series
	RAMDisk	C:\Data\RAMDisk	\RAMDISK
	External memory	E:\, F:\, G:\, H:\, M:\ (FH series only)	\USBdisk to \USBdisk3

IMPORTANT

- Do not turn off power to the Sensor Controller until there is a response.

(Example)

When you load the following case:

- Scene group number: 3
- SCNLOAD file name: LABEL1.SGP
- Drive name: USBDisk2
- Folder name of the external memory: IMG01

<Command>

`SGRLOAD 3 \ USBDisk2 \ IMG01 \ LABEL1.SGP` ^{CR}

<Response>

`OK` ^{CR}

Note

- For the USB memory drive, see *Saving Data to the FH/FZ5* in the *Vision System FH/FZ5 Series User's Manual* (Cat. No. Z365)

SGRSAVE

Saves scene group data.

<Command format>



<Response format>

When processing is performed normally

OK^{CR}

When processing is not performed normally

ER^{CR}

<Parameters explanation>

Scene group No.	Specifies the scene group No. to save (0 to 31).		
Destination	The name of the file containing the Scene Group data you wish to save. Specify the folder name as an absolute path. The file name needs the "SGP" extension. The save destination folder differs depending on the Sensor Controller series.		
	Save destination	FH series/FZ5-800 series/FZ5-1100 series/FZ5-1200 series^{*1}	FZ5-L series/FZ5-600 series
	RAMDisk	C:\Data\RAMDisk	\RAMDISK
	External memory	E:\, F:\, G:\, H:\, M:\ (FH series only)	\USBdisk to \USBdisk3

*1: Do not specify a save destination other than RAMDisk or External memory, i.e. C:\ProgramFiles\FZ
The saved Scene data area may be reduced and the Sensor Controller will not perform correctly.

IMPORTANT

- If the specified file name already exists, this existing file will be overwritten.
- Do not turn off power of the Sensor Controller until return the response.
- For the FH/FZ5-800/FZ5-1100/FZ5-1200 series, do not save to a non-volatile area on the C drive (such as C:\ProgramFiles\FZ). This would reduce the storage area for scene data etc. and make correct operation impossible.

(Example)

When you save the following case:

- Scene group number: 3
- SCNSAVE file name: LABEL.SGP
- Drive name: USBDisk2
- Folder name of the external memory: IMG01

<Command>

SGRSAVE 3 \ USBDisk2 \ IMG01 \ LABEL.SGP^{CR}

<Response>

OK^{CR}

SYSDATA

Acquires settings related to logging

Acquires settings related to current logging.

<Command format>

```
SYSDATA Logging [ ] CR
                |
                | Identifier
```

<Response format>

When processing is performed normally

```
Measurement value CR
OK CR
```

When processing is not performed normally

```
ER CR
```

<Parameters explanation>

Data	Identifier	Setting value
Image logging	imageLogging	0: None 1: Only NG 2: All
Folder name of image logging save destination	imageLoggingDirectory	Save destination folder name (one-byte alphanumeric character)
Prefix for image logging file name	imageLoggingHeader	Prefix for image logging file name (one-byte alphanumeric characters)
Data logging	dataLogging	0: None 1: Only NG 2: All
Name of destination folder for saving data logging	dataLoggingDirectory	Save destination folder name (one-byte alphanumeric character)

IMPORTANT

The save destination folder differs depending on the Sensor Controller model.
When you use FH series/FZ5-800/FZ5-1100/FZ5-1200 series, do not save to the any folder except RAMDisk and external memory device (such as C:\ProgramFiles\FZ).
It is possible not to perform correctly due to the decrease of Scene data storage region.

Save destination	FH series/FZ5-800 series/ FZ5-1100 series/FZ5-1200 series	FZ5-L series/FZ5-600 series
RAMDisk	C:\Data\RAMDisk	\RAMDISK
External memory	E:\, F:\, G:\, H:\, M:\ (FH series only)	\USBdisk to \USBdisk3

(Example)

Getting the image logging setting when the setting for the current image logging save condition is 1 (save only NG)

<Command>

S Y S D A T A L o g g i n g i m a g e L o g g i n g ^{C_R}

<Response>

1 ^{C_R}

OK ^{C_R}

The current image logging save condition is "1: Only NG".

Changes settings related to logging

Changes settings related to current logging.

<Command format>

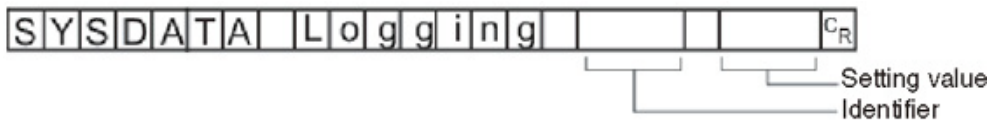

<Response format>

When processing is performed normally

OK^{CR}

When processing is not performed normally

ER^{CR}

<Parameters explanation>

Data	Identifier	Setting value
Image logging	imageLogging	0: None 1: Only NG 2: All
Folder name of image logging save destination	imageLoggingDirectory	Save destination folder name (one-byte alphanumeric character)
Prefix for image logging file name	imageLoggingHeader	Prefix for image logging file name (one-byte alphanumeric characters)
Data logging	dataLogging	0: None 1: Only NG 2: All
Name of destination folder for saving data logging	dataLoggingDirectory	Save destination folder name (one-byte alphanumeric character)

IMPORTANT

The save destination folder differs depending on the Sensor Controller model.

When you use FH series/FZ5-800/FZ5-1100/FZ5-1200 series, do not save to the any folder except RAMDisk and external memory device (such as C:\ProgramFiles\FZ).

It is possible not to perform correctly due to the decrease of Scene data storage region.

Save destination	FH series/FZ5-800 series/ FZ5-1100 series/FZ5-1200 series	FZ5-L series/FZ5-600 series
RAMDisk	C:\Data\RAMDisk	\RAMDISK
External memory	E:\, F:\, G:\, H:\, M:\ (FH series only)	\USBdisk to \USBdisk3

(Example 1)

When creating settings so that data logging is only performed during NG errors

<Command>

S Y S D A T A L o g g i n g d a t a L o g g i n g 1 C_R

<Response>

OK C_R

(Example 2)

When the RAMDisk is set as the image logging save destination

<Command>

For FZ5-L35□/FZ5-6□□

S Y S D A T A L o g g i n g i m a g e L o g g i n g D i r e c t o r y \ R A M D i s k C_R

For FH/FZ5-8□□/FZ5-11□□/FZ5-12□□

S Y S D A T A L o g g i n g i m a g e L o g g i n g D i r e c t o r y C : \ D a t a \ R A M D i s k C_R

<Response>

OK C_R

SYSLOAD

Reads system data.

<Command format>

`SYSLOAD` `_____` `CR`
└──────────┘ File name of system data

<Response format>

When processing is performed normally

`OK` `CR`

When processing is not performed normally

`ER` `CR`

<Parameters explanation>

File name of System data	The name of the file containing the System data you wish to load. Specify the file name as an absolute path. The file name needs the "INI" extension. The file which has "INI" extension can be load. The load destination to use differs by Sensor Controller model.		
	Load destination	FH series/FZ5-800 series/FZ5-1100 series/FZ5-1200 series	FZ5-L series/FZ5-600 series
	RAMDisk	C:\Data\RAMDisk	\RAMDISK
External memory	E:\, F:\, G:\, H:\, M:\ (FH series only)	\USBdisk to \USBdisk3	

IMPORTANT

- Do not turn off power to the Sensor Controller until there is a response.

(Example)

When you load the following case:

- SYSLOAD file name: LABEL.INI
- Drive name: USBDisk2
- Folder name of the external memory: IMG01

<Command>

`SYSLOAD` `\ USBDisk2 \ IMG01 \ LABEL.INI` `CR`

<Response>

`OK` `CR`

SYSSAVE

Saves system data.

<Command format>

`SYSSAVE [] [] CR`
Save destination

<Response format>

When processing is performed normally

`OK CR`

When processing is not performed normally

`ER CR`

<Parameters explanation>

Destination	The name of the file containing the System data you wish to save. Specify the folder name as an absolute path. The file name needs the "INI" extension. Save destination folder differs depending on the Sensor Controller series.		
	Save destination	FH series/FZ5-1100 series ^{*1}	FZ5-L series/FZ5-600 series
	RAMDisk	C:\Data\RAMDisk	\RAMDISK
External memory	E:\, F:\, G:\, H:\, M:\ (FH series only)	\USBdisk to \USBdisk3	

*1: Do not specify a save destination other than RAMDisk or External memory, i.e. C:\ProgramFiles\FZ
The saved Scene data area may be reduced and the Sensor Controller will not perform correctly.

IMPORTANT

- If the specified file name already exists, this existing file will be overwritten.
- Do not turn off power of the Sensor Controller until return the response.
- Do not specify to the any folder except RAMDisk and external memory device (such as C:\ProgramFiles\FZ) when you use FH series/FZ5-1100 series. It is possible not to perform correctly due to the decrease of Scene data storage region.

(Example)

When you save the following case:

- SYSSAVE file name: LABEL.INI
- Drive name: USBDisk2
- Folder name of the external memory: IMG01

<Command>

`SYSSAVE [] \ USBDisk2 \ IMG01 \ LABEL.INI CR`

<Response>

`OK CR`

TIMER or TMR

Issues the specified command string after a specified delay.

<Command format>

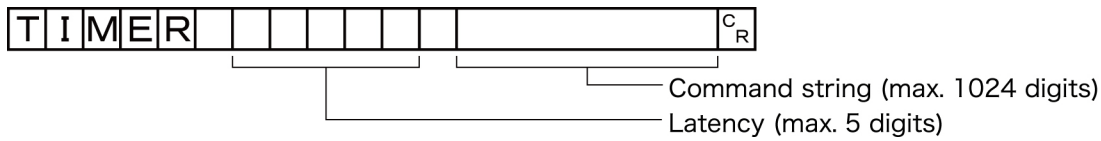

or

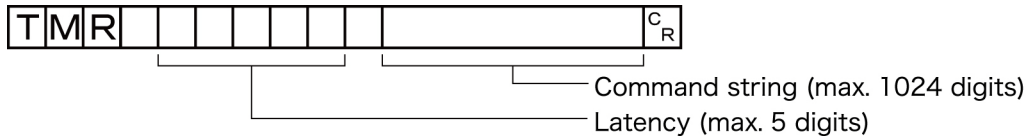

<Response format>

When processing is performed normally

OK^{C_R}

When processing is not performed normally

ER^{C_R}

<Parameters explanation>

Latency	Specifies the required delay to when the specified command is issued in milliseconds, 100 to 99999.
Command string	Specifies the command string. (Max: 1024 characters)

(Example)

Getting the current scene number (scene 1) after 3,000 ms

<Command>

TMR 3000 S^{C_R}

<Response>

1^{C_R}

OK^{C_R}

UNITDATA or UD

Acquiring processing unit parameters and measurement values

The set parameters and measurement values for the processing units set in the scene currently being used are acquired.

<Command format>

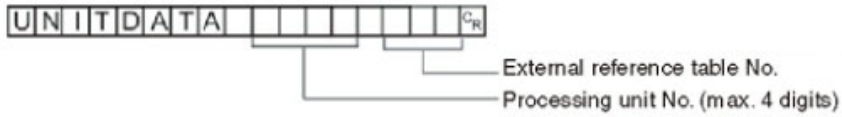

<Response format>

When processing is performed normally

Measurement value C_R
OK C_R

When processing is not performed normally

ER C_R

<Parameters explanation>

Processing unit No.	Specifies the processing unit number (0 to the number of unit items -1).
External reference table No.	Varies depending on the specified processing unit processing items. For more details, refer to External Reference Table for each processing item in Processing Item List Manual.
Measurement	The acquired measurement value is output as a response.

(Example)

Getting the value of the search judgement result (external reference 0) that was set in processing unit 5 for the judgement OK status

<Command>

UNITDATA 5 0 C_R

<Response>

1 C_R
OK C_R

Changing processing unit parameters

The set parameters for the processing units set in the scene currently being used are changed.

<Command format>

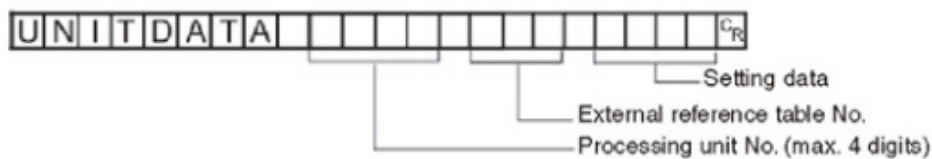

<Response format>

When processing is performed normally

OK^{CR}

When processing is not performed normally

ER^{CR}

<Parameters explanation>

Processing unit No.	Specifies the processing unit number (0 to the number of unit items –1).
External reference table No.	Varies depending on the specified processing unit processing items. For more details, refer to External Reference Table for each processing item in Processing Item List Manual.
Setting Data	Sets the value of the settings data.

(Example)

When "Skipping angle" (external reference table value "124") in [Search] set as the 6th processing unit (processing unit number "5") is changed to "10"

<Command>

UNITDATA 5 124 10^{CR}

<Response>

OK^{CR}

(Example)

When "Verification string" (external reference table value "139") in [Character Inspection] set as the 7th processing unit (processing unit number "6") is changed to "ABC"

<Command>

UNITDATA 6 139 ABC^{CR}

<Response>

OK^{CR}

Note

To set a character string which includes spaces, enclose the character string with " ".

Example

Setting the character string to compare (value of external reference table no. 164 value) as "ABC EFG" of the second processing unit (Processing unit No.1).

UNITDATA 1 164 "ABC EFG"

UPDATEMODEL or UMD

Reregisters a model using the current image.

<Command format>

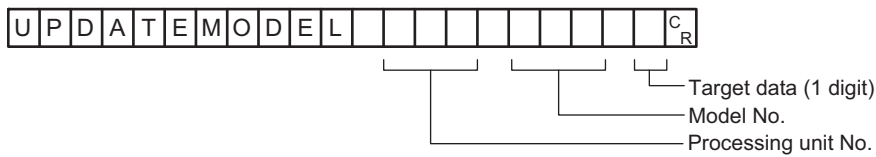

or

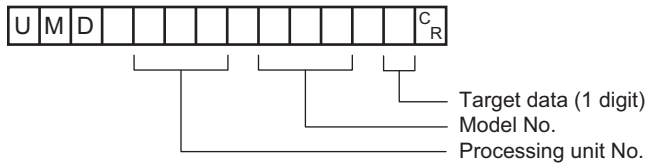

<Response format>

When processing is performed normally

OK_{CR}

When processing is not performed normally

ER_{CR}

<Parameters explanation>

Processing unit No.	Specifies the processing unit number of a model to reregister: 0 to the number of unit items – 1.
Model No.	Specifies the model number to register a model: 0 to the uppermost unit model number in the unit. Specifying a nonexistent model number causes an error.
Target data	Specifies the target data. When the setting value is expressed in binary, if the 1st bit is 1, the model is re-registered. When the setting value is expressed in binary, if the 2nd bit is 1, the reference position is updated. When the setting value is expressed in binary, if the 3rd bit is 1, the detection position is updated. Example) <ul style="list-style-type: none"> • When only re-registering the model: $1 \times 1 + 2 \times 0 + 4 \times 0 = 1$ (setting value) • When only updating the reference position: $1 \times 0 + 2 \times 1 + 4 \times 0 = 2$ (setting value) • When updating or re-registering everything: $1 \times 1 + 2 \times 1 + 4 \times 1 = 7$ (setting value)

(Example)

The following sample command reregisters a model with unit number 3, model number 0 and target data 1.

<Command>

U	M	D		3		0		1	C _R
---	---	---	--	---	--	---	--	---	----------------

<Response>

O	K	C _R
---	---	----------------

USERACCOUNT or UAD

Adds user account to specified user group

Adds the user account to the specified affiliated group ID.

If the user account for the set image is already registered, that setting is overwritten.

<Command format>

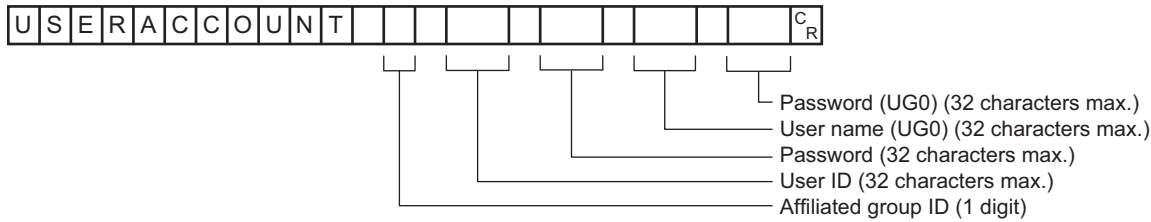

or

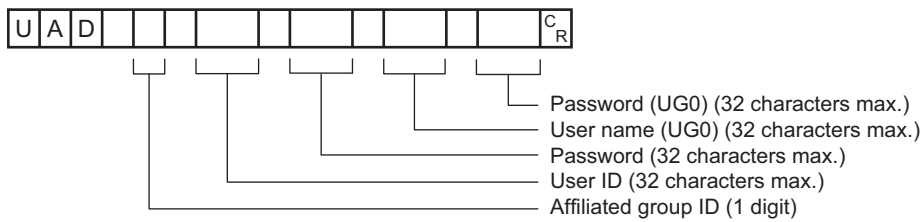

<Response format>

When processing is performed normally

OK^{CR}

When processing is not performed normally

ER^{CR}

<Parameters explanation>

Group	Specifies a group ID to which a user account is to be added: 0 to 7.
User ID	Specifies a user ID of the user to be added with up to 32 characters.
Password	Specifies a password for the user to be added with up to 32 characters.
User name (UG0)	Specifies the user name for a user belonging to the UG0 group (32 characters maximum).
Password (UG0)	Specifies the password for the above UG0 group user (32 characters maximum).

(Example)

Using the UG0 password *efg* for user *olduser* to add an account with user name *newuser* with password *abc* in the UG0 group

<Command>

U A D 0 n e w u s e r a b c o l d u s e r e f g ^{CR}

<Response>

OK^{CR}

VERGET

Acquires the Sensor Controller version information.

<Command format>

VERGET^{C_R}

<Response format>

When processing is performed normally

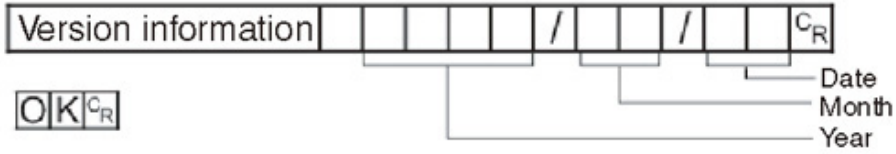

When processing is not performed normally

ER^{C_R}

<Parameters explanation>

Version information	<ul style="list-style-type: none"> • Sensor Controller model name • Software version
---------------------	--

(Example)

When your software version is "5.00", and the date is "June 1, 2013"

<Command>

VERGET^{C_R}

<Response>

FZ / FH / FJ - XXX Ver . 5 . 0 0 2 0 1 3 / 0 6 / 0 1 C_R

OK^{C_R}

Manual Revision History

The manual revision symbol is an alphabet appended at the end of the manual number found in the bottom left-hand corner of the front or back cover.

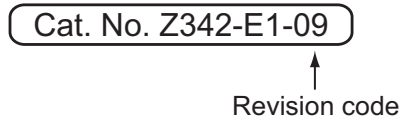

Rev. No.	Rev. Date	Revision Contents	Software Version
01	Jul. 2013	Original production	Ver. 5.00
02	Aug. 2013	Additions for software version upgrade.	Ver. 5.10
03	Sep. 2013	Additions for software version upgrade.	Ver. 5.12
04	Jan. 2014	Additions for software version upgrade.	Ver. 5.20
05	Jun. 2014	Additions for software version upgrade.	Ver. 5.30
06	Oct. 2015	Additions for software version upgrade.	Ver. 5.50
07	Apr. 2016	Additions for software version upgrade and descriptions of FH-L series.	Ver. 5.60
08	Mar. 2017	Corrected mistakes. Additions for software version upgrade.	Ver. 5.71
09	Jun. 2017	Additions for software version upgrade.	Ver. 5.72

OMRON Corporation Industrial Automation Company
Kyoto, JAPAN

Contact: www.ia.omron.com

Regional Headquarters

OMRON EUROPE B.V.

Wegalaan 67-69, 2132 JD Hoofddorp
The Netherlands
Tel: (31)2356-81-300/Fax: (31)2356-81-388

OMRON ELECTRONICS LLC

2895 Greenspoint Parkway, Suite 200
Hoffman Estates, IL 60169 U.S.A.
Tel: (1) 847-843-7900/Fax: (1) 847-843-7787

OMRON ASIA PACIFIC PTE. LTD.

No. 438A Alexandra Road # 05-05/08 (Lobby 2),
Alexandra Technopark,
Singapore 119967
Tel: (65) 6835-3011/Fax: (65) 6835-2711

OMRON (CHINA) CO., LTD.

Room 2211, Bank of China Tower,
200 Yin Cheng Zhong Road,
PuDong New Area, Shanghai, 200120, China
Tel: (86) 21-5037-2222/Fax: (86) 21-5037-2200

Authorized Distributor:

© OMRON Corporation 2013-2017 All Rights Reserved.
In the interest of product improvement,
specifications are subject to change without notice.

Cat. No. Z342-E1-09

0617