

Like or even more than the human eye



Vision System

FH Series



- A complete line-up of cameras for various applications
- Powerful controllers for fast and precise inspection and measurement
- Software for easy setting of various measurements

Best-in class image sensing speed and precision - like or even more than the human eye

Omron has packed image sensing technology for inspection and measurement necessary for automation into compact devices. The FH Series includes software for inspection and measurement in addition to cameras that can capture high-sensitivity and high-resolution images. This vision system, substituted for the human eye, provides high-speed and high-precision inspection and measurement without complex programming and device combination.

Vision System

FH Series

A complete line-up of cameras for various applications



NEW Rolling Shutter Camera
FH-SC05R/SM05R



Powerful controllers for fast and precise inspection and measurement

NEW Advanced functionality in a compact size
FH-L550/L550-C10



Software for easy setting of various measurements

A complete line-up of cameras for various applications



For applications requiring high speed and high resolution

Lens mount camera

You can select the best combination of camera and lens for your application.

Speed

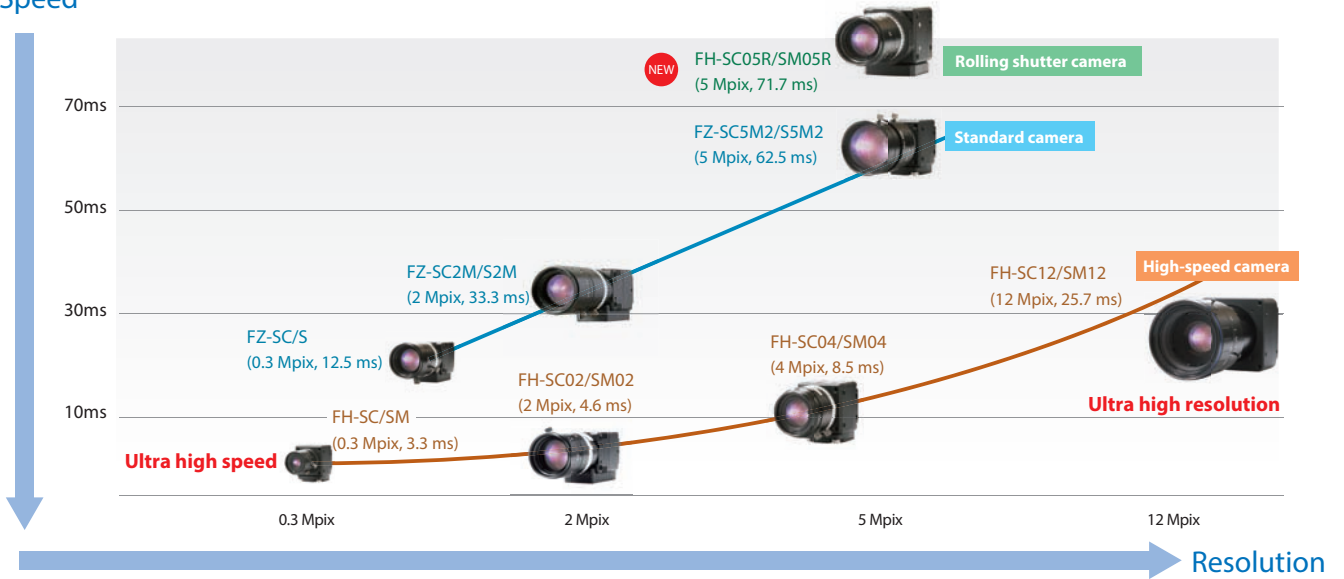

Rolling shutter camera added to the line-up

The benefits of cost-effective rolling shutter cameras are now being recognized once again.

The rolling shutter camera scans the pixels of each line. Although this produces distortions of moving objects, high-resolution yet cost-effective inspection and measurement can be performed.

	Rolling shutter	Global shutter
Stationary object		
Moving object		

Easy to install into machines

Camera with built-in light

The all-in-one camera including the light and lens can be easily integrated into almost any machine.

* The FQ2 Smart Cameras are also available.



High-power lighting

The sensor has a built-in high-power light capable of evenly lighting across a wide field of view.

This provides sufficient lighting even when the enclosed polarizing filter is used.

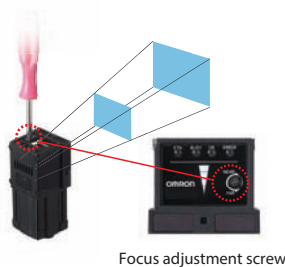

Adjustable lens

The focus of the lens can be adjusted to take clear images for the specific field of view and installation distance you need.

For narrow space

Small camera

The ultra-compact lens can be installed into limited space in a machine. Select the flat or pen type depending on space.



This is the size with nothing other than a lens (FZ-LES3).

Powerful controllers for fast and precise inspection and measurement



You can select the best controller to suit requirements.
All controllers can share the same settings, bringing flexibility to machine design.







	FH-3050 Series	FH-1050 Series	FH-L550 Series
			
Processing speed (CPU)	 4 core High speed	 2 core High speed	 2 core Mid speed
No. of connectable cameras	2 to 8	2 to 8	2 to 4
Multi-line processing	✓	✓	—
EtherCAT	✓	✓	—
EtherNet/IP	✓	✓	✓
Connectable camera	All FH and FZ cameras		

Image transfer without delay

The FH-3050/-1050 Series has a high-performance bus to transfer images, maximizing the specifications of any connected camera.

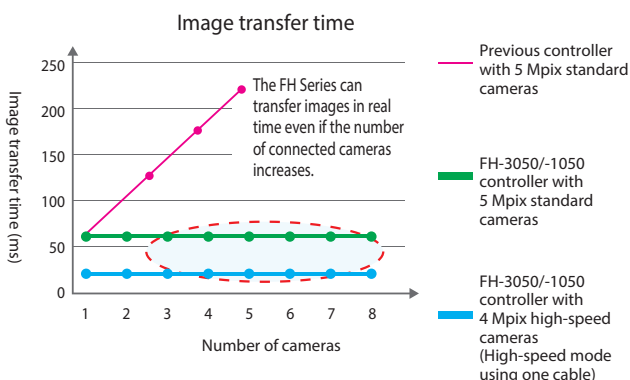

Note: The image conversion processing time is not included.

The FH-3050/-1050 Series can transfer large amounts of image data in real time.

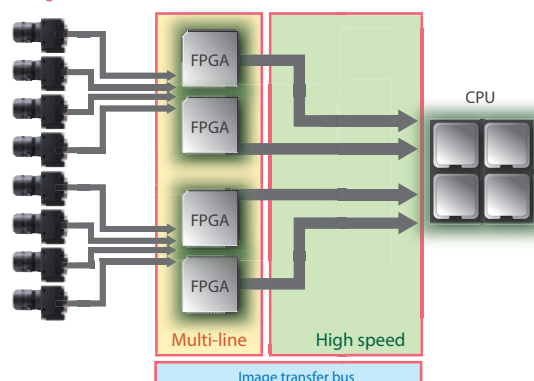

Object detection algorithm Shape Search III for fast and precise inspection and measurement

High-precision object detection

Low-error position detection even with blurry images

Over many years, Omron has perfected techniques to search for and match templates at high speed. This experience and expertise enables us to develop the Shape Search III vision algorithm, which provides advanced robustness and is critical on FA sites. When measuring lamination of glass or other processes where the distance to the workpiece from the camera varies, size differences and focal shifts can occur. Even in cases like this, the new Shape Search III algorithm detects positions with limited error.

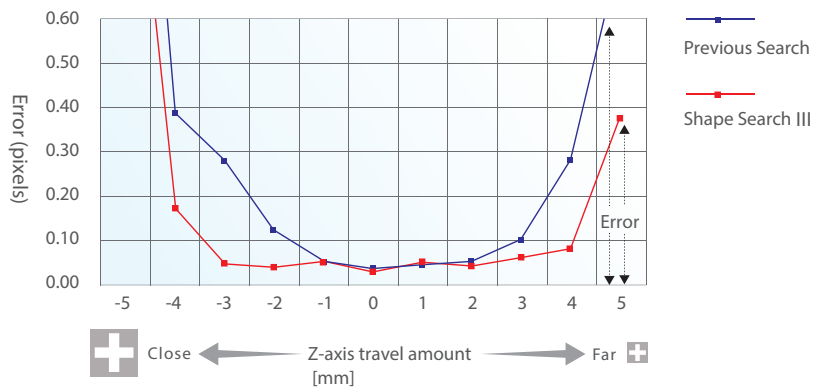
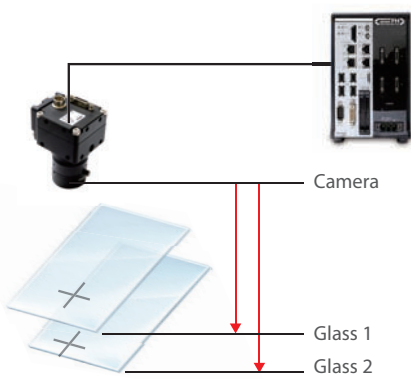

Stable searching with limited error even under adverse conditions

Stable searching is possible even under the following adverse conditions, which occur far too often in actual measurement applications.

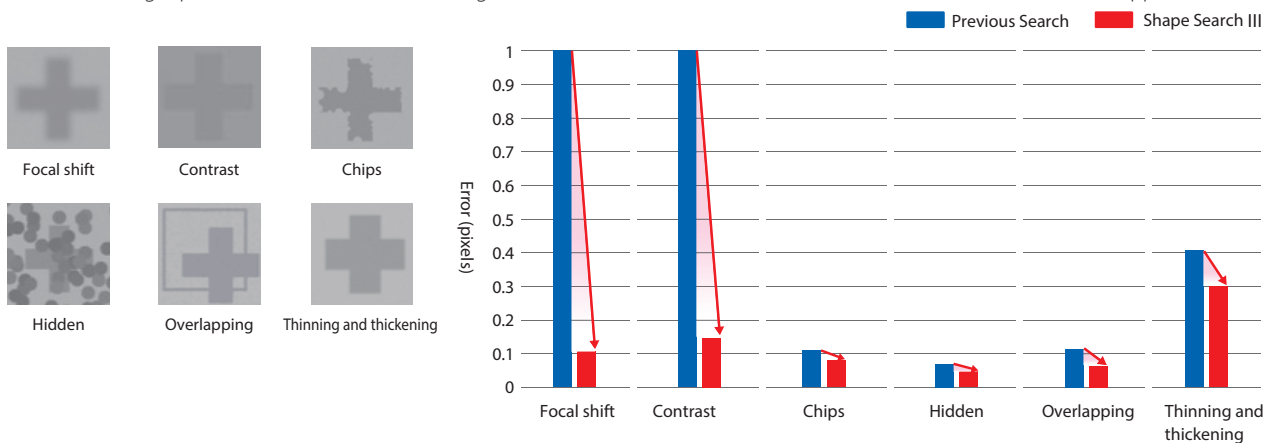

Detection of multiple workpieces

Even if many workpieces are within the field of view, searching is possible without compromising detection accuracy.

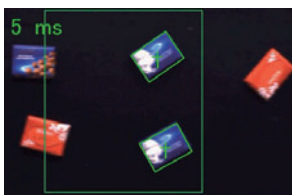

The different types of the searched workpieces can be classified.



Detection of workpieces from background noise and detection of shiny workpieces

Stable searching is possible without being affected by the background or glass.

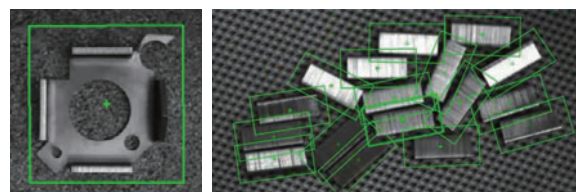



What is Think & See?

Powerful core technologies for image sensing. Omron is continuously developing technologies to measure, detect, or identify the positions, orientations, shapes, materials, colors, status, or attributes of things, people, vehicles, or other objects faster, more precisely, and more easily than the human eye under various conditions.

Shape Search III is based on the Think & See technology.



See the details of Think & See.

<http://www.omron.com/technology/core/thinkAndSee/>

Ultra-high-speed searching 9 times faster than before

New technology makes search algorithms up to nine times faster than before. Even for unstable image conditions (including light interference, overlapping shapes, gloss, and incomplete images), stable searching is now possible without reducing speed.

Ultra-high-speed search processing time

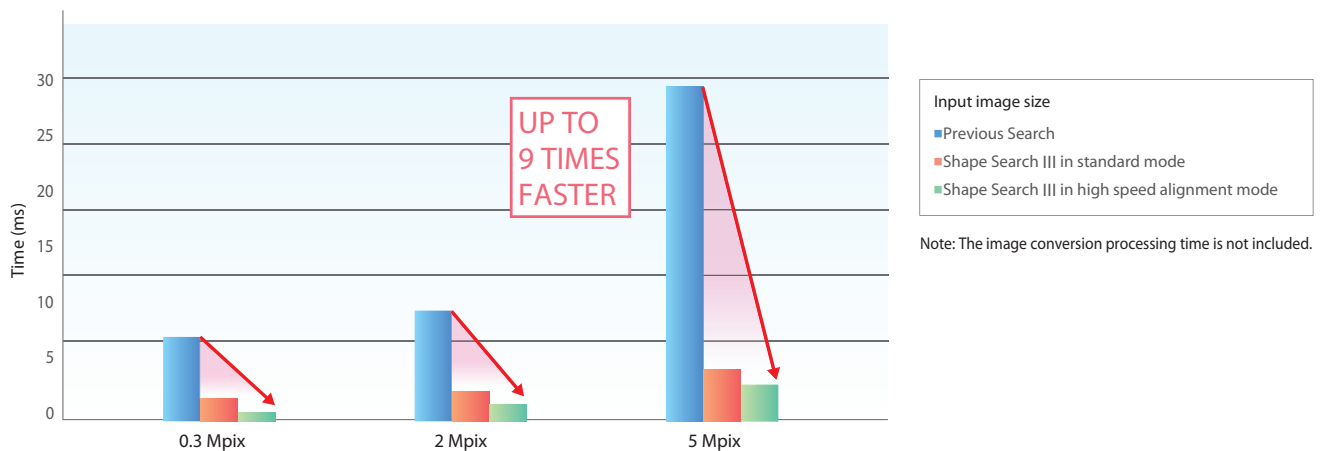

Visualization of comparisons enables easy setting of high-precision searching Patent Pending

Advanced searching is accompanied by many parameters that must be tuned to match the application. However, it is difficult for the person making the settings to see the internal process. Normally, a lot of time and effort is required to maximize tool performance. But with Shape Search III, you can visualize comparisons between the model data and a part of the measurement object to easily see when comparisons are not optimally matched. Visualization of the comparison level allows for parameters to be adjusted to quickly obtain the best performance.

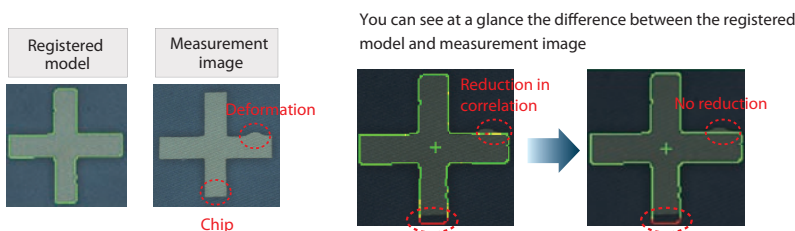

You can adjust a parameter called the Acceptable Distortion Level to enable measurements without reducing the correlation even if there is distortion. You can easily adjust this parameter while monitoring the comparison.

Preinstalled GUIs - for designers and for operators

GUI for operators

Operation interfaces are preinstalled in the FH Series. You can display operation interfaces just by switching screens, without time-consuming interface development work.

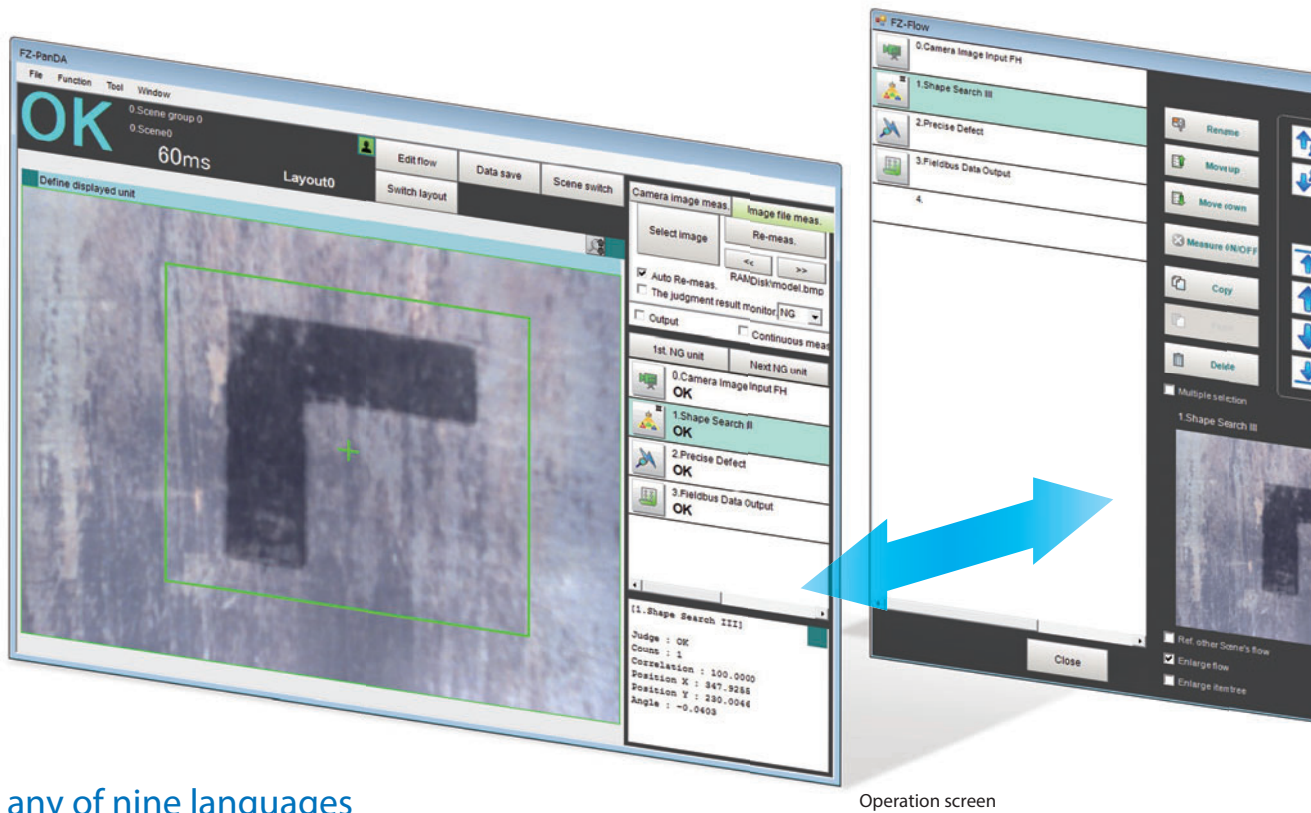

Choose any of nine languages

You can change display messages between nine different languages: English, Chinese, Japanese and other languages. Display the best language for the user for applications in other countries.

Touch screen ideal for on-site operation



The IP65-certified touch screen for the FH Series is available (FH-MT12). The resistive film method allows easy operation with a gloved hand.

Easy customization of interface

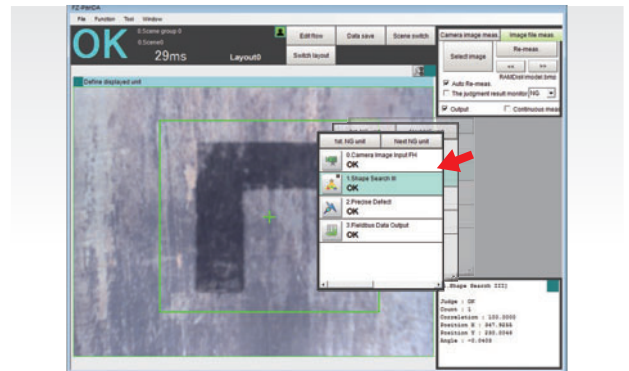

You can easily customize the preinstalled interfaces just by dragging and dropping.



GUI for designers

The setting of inspection and measurement can be done by combining processing items to create a flow.
 GUI for detailed setting for measurement conditions allows intuitive operation.

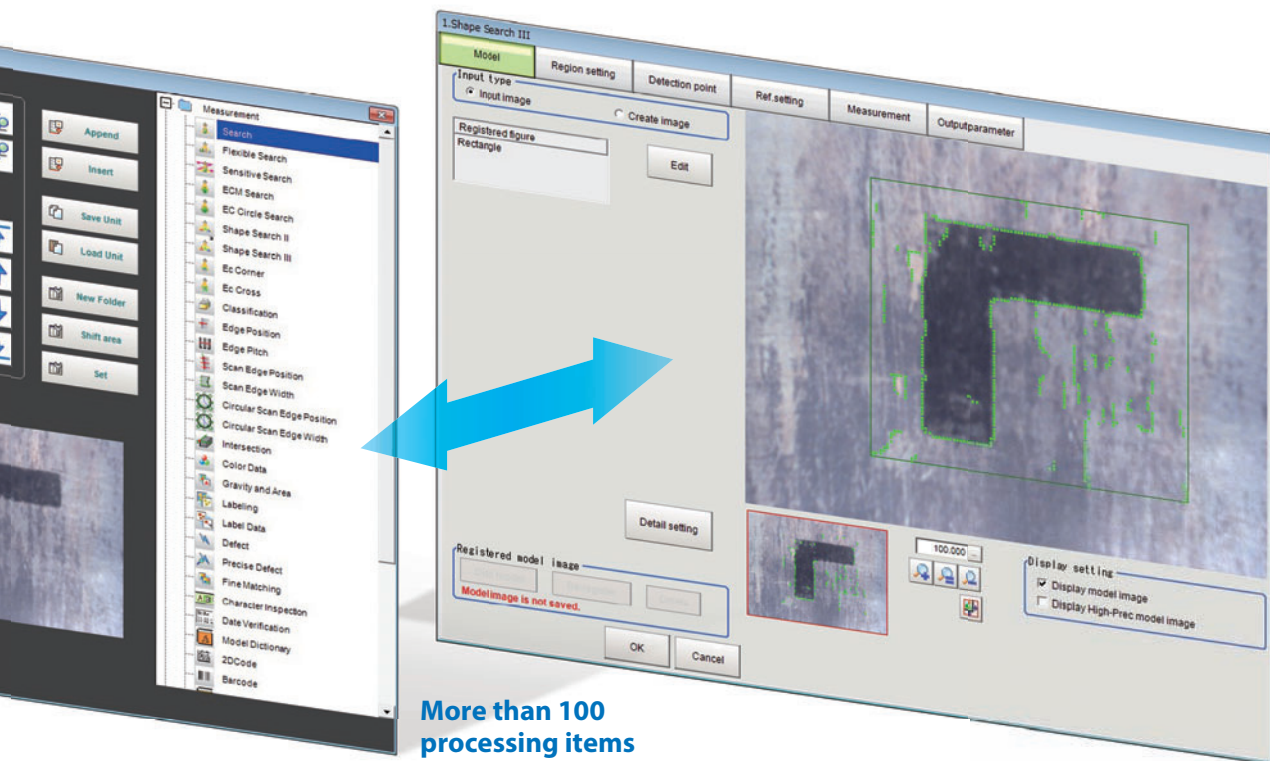

More than 100 processing items

Measurement flow setting screen

Measurement condition setting screen

Inspection flow design

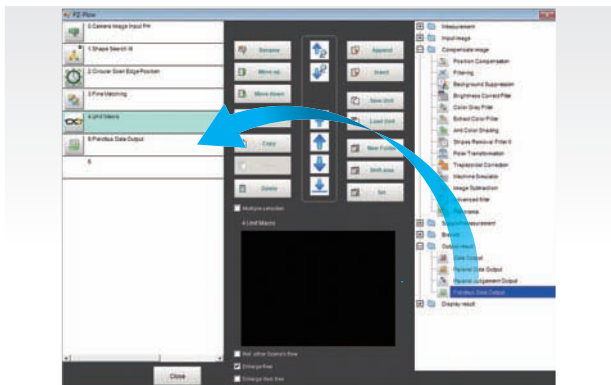

Drag and drop processing items to create inspection and measurement flows. Flow creation at production sites, offline flow creation, and simulations are possible.

Simple programming

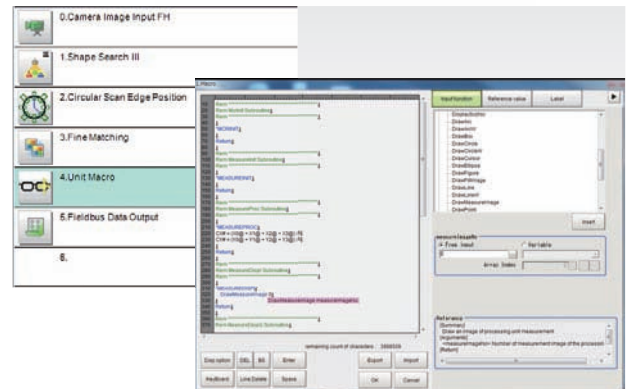

User-defined macro can be used for complex data processing that cannot be performed by inspection flows. The BASIC-like programming language facilitates the macro creation.

Flexible functionalities to provide high compatibility with manufacturing machines

Remote operation via Ethernet

The Remote Operation Tool is provided to control the FH Series from a remote location via Ethernet. Just install the tool on your PC and specify the IP address.

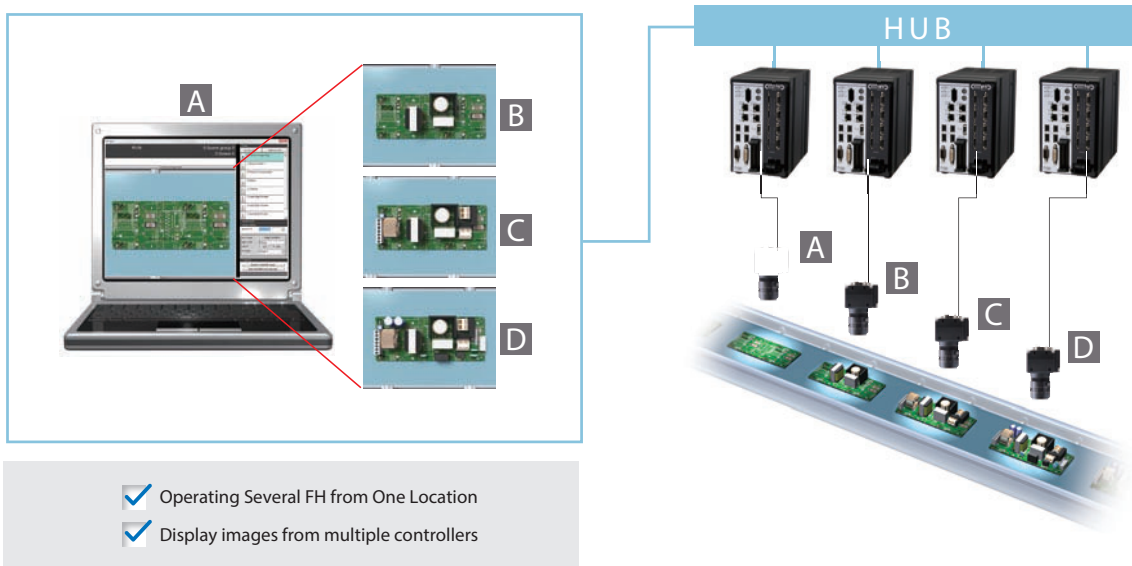

Note: Ask your OMRON representative about obtaining simulation software for a computer.

Integration into user applications

Microsoft.Net software components are supported to integrate the FH interfaces into a PC-based HMI. You can add components that display FH screens and measurement results to your HMI software just by dragging and dropping.

The screenshot shows the FZ-PanDA HMI software interface. The main window displays a camera image of a component with a green bounding box. A measurement results panel on the right shows the following data: Judge: OK, Count: 1, Correlation: 100.0000, Position X: 347.9266, Position Y: 230.0046, Angle: -0.0403. A callout box on the left shows a smaller version of the camera image, labeled 'Component to display measurement images'. A callout box on the right shows a smaller version of the entire HMI window, labeled 'Component to display the entire screen'. Another callout box on the right shows a smaller version of the measurement results panel, labeled 'Component to display measurement results'.

Note: Ask your OMRON representative about the software components.

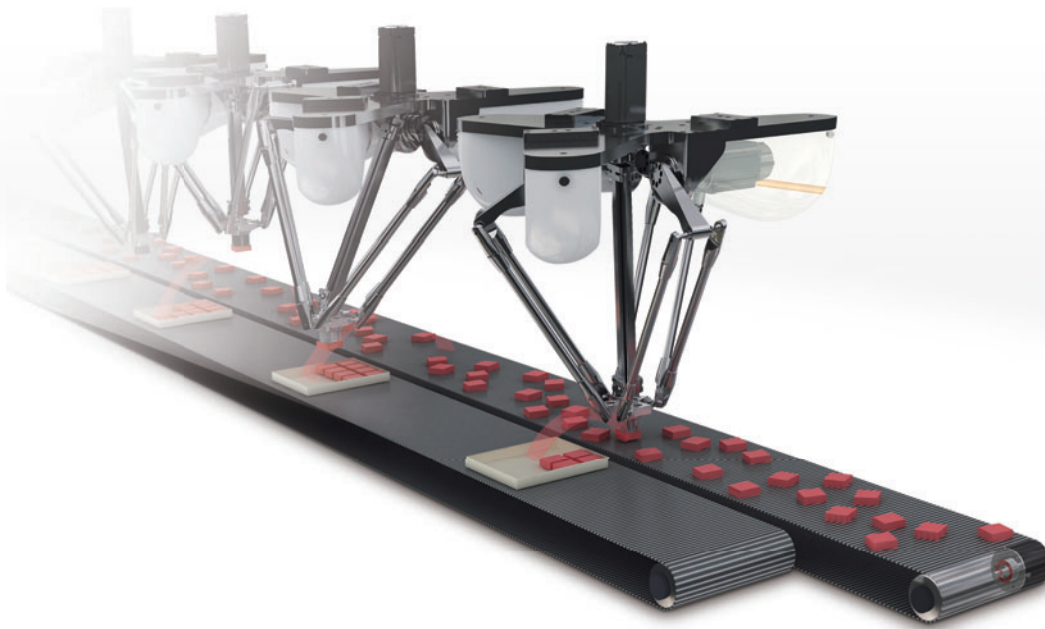

Integrated development environment

The Automation Software Sysmac Studio integrates setting and operation of the NJ/NX Machine Automation Controller and FH Series. Simulate and debug motion control, logic, drives, and sensing on an integrated platform to reduce the work required for machine design.

Vision system simulation

Inspection and measurement by vision systems can be simulated from the Sysmac Studio.



Data tracing

Inputs and outputs of vision systems can be traced as a time series.

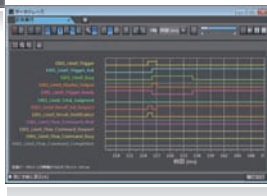

3D Simulation

Patent Pending

Machine movement can be simulated based on measurement results of vision systems.

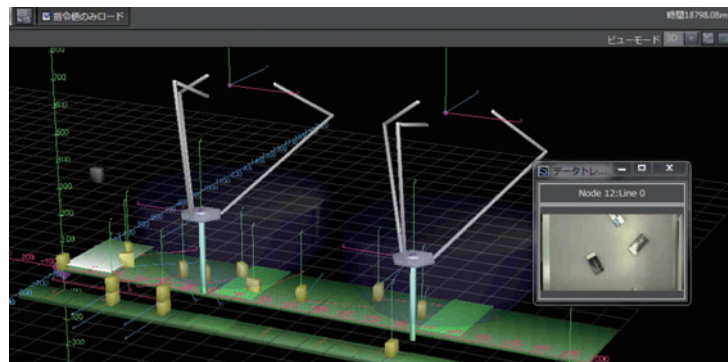

Software customization

The Application Producer (FH-AP1) provides a development environment that lets you customize software preinstalled in the FH Controller. Original interfaces created with Microsoft Visual Studio can be used with the FH Controller.

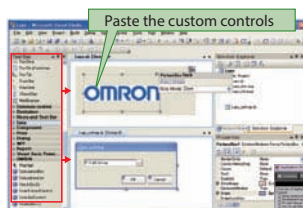

Develop original interfaces with Microsoft Visual Studio



Create installation files for the FH Controller with Application Producer

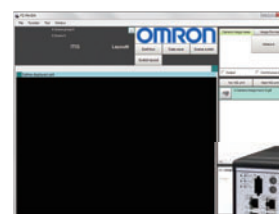

Install the created software on the FH Controller



High immunity against ambient light for reliable inspection



Glue bead and shape inspection application

Even workpieces with surfaces that are difficult to inspect (e.g. metal cutting surface) can be reliably inspected.

■ Inspection flow example

	0.Camera Image Input HDR
	1.Iris
	2.Focus
	3.Image Subtraction
	4.Glue Bead Inspection

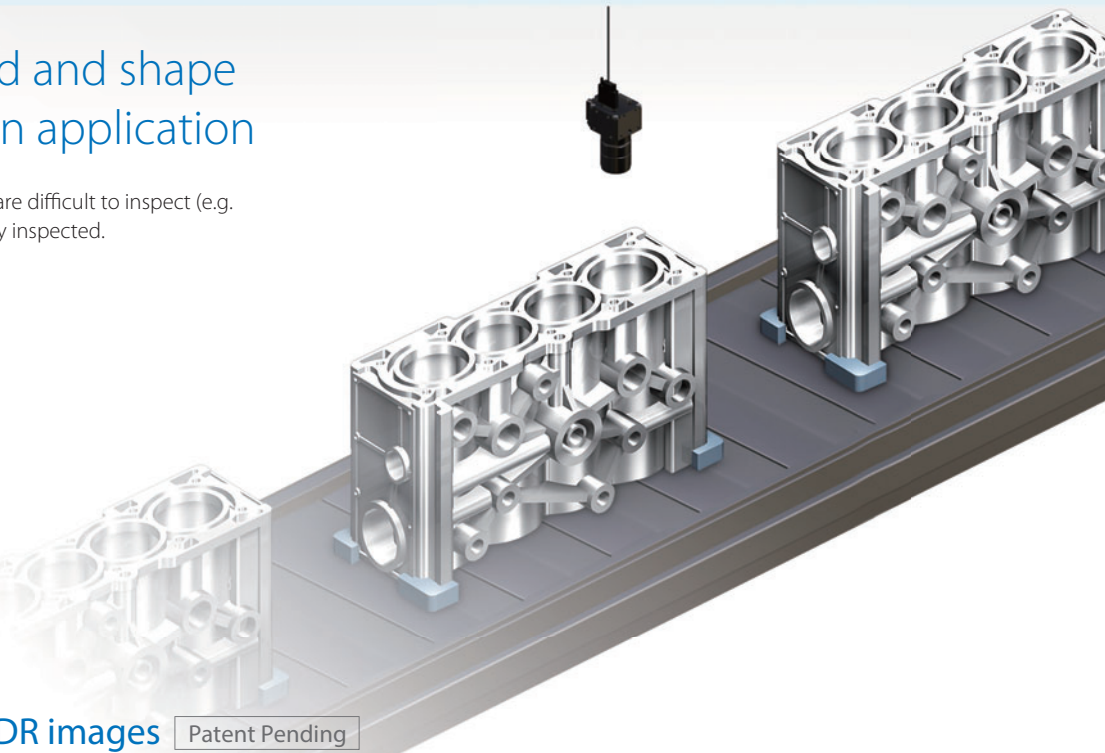

Easy to create HDR images Patent Pending

The Camera Image Input HDR processing item can create optimized HDR images under variable ambient conditions. Normally, to create a HDR image, you must set the imaging conditions for each shooting. However with the FH Series, once you specify the area to capture on the image, the vision system automatically adjusts the shutter speed while capturing images and combines the images.

Image optimized for the specified area



Optimized for the bright part



Optimized for the entire field of view



Optimized for the dark part



Optimum focus and aperture settings

Until now, focus and brightness settings were adjusted according to experience and intuition. But now they can be evaluated numerically and visually on graphs. This allows quick verification of optimum focus and aperture settings to eliminate inconsistencies in settings caused by worker differences so that you can achieve even higher levels of measurement accuracy.

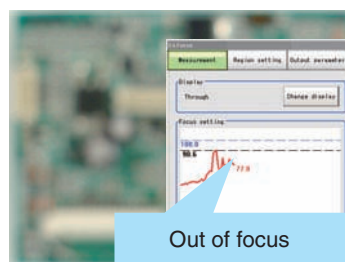

Out of focus

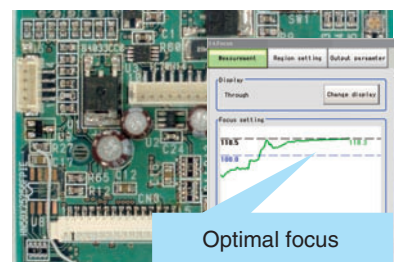

Optimal focus

- Camera installation and setup are easy.
- Errors can be generated when the focus or aperture changes.
- You can determine the numerical values for the focus and aperture for the master workpiece so that essentially anyone can reproduce the same conditions.

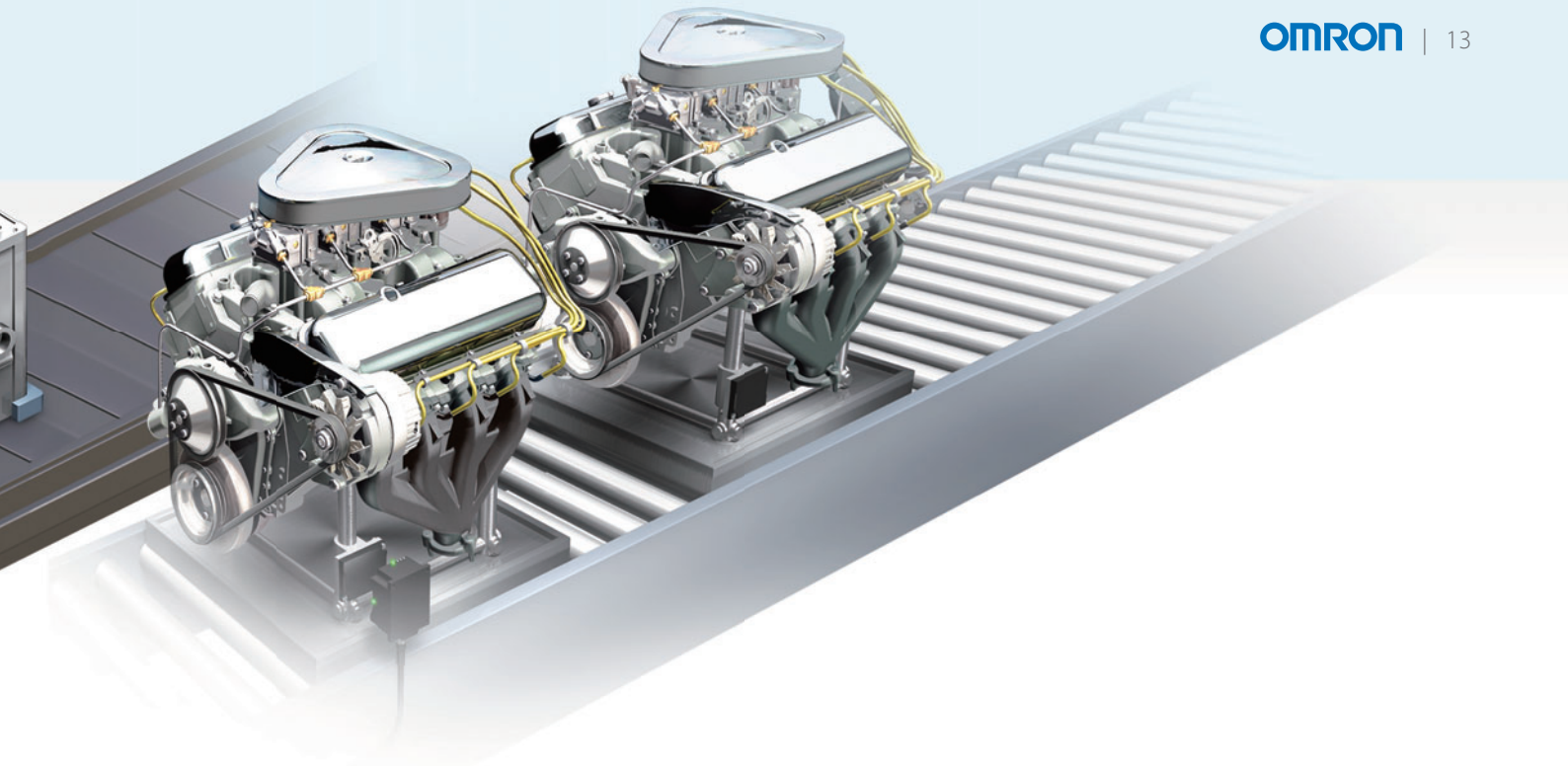

Extraction of objects to inspect

When the complete sealing is inspected, the effects of unstable conditions can be eliminated by updating the image that is captured before applying the sealant and registered as the master. The FH Series can easily update the master image to extract the difference just by using the Image Subtraction processing item. Image Subtraction processing item.

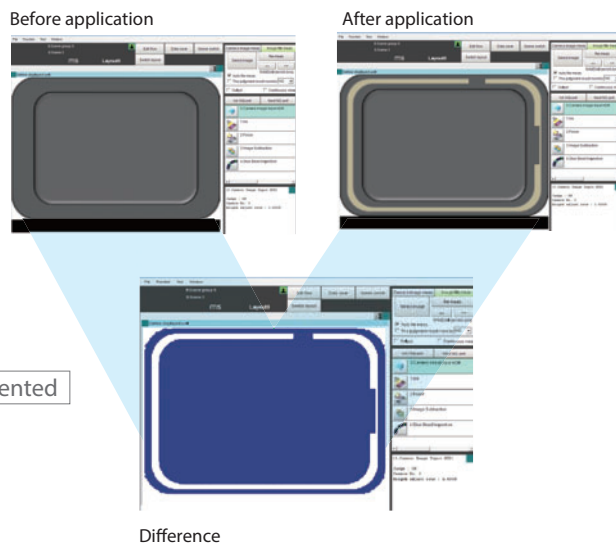

Inspection of paths and widths Patented

The Glue Bead Inspection processing item evaluates sealing numerically just by defining the start and end points of the object to inspect. This minimizes inconsistencies in inspection. Even complex paths can be detected accurately.

Unlike the general width inspection using edges, the profile of the object is used to inspect.

This method enables accurate inspection of complex curves and interruptions.

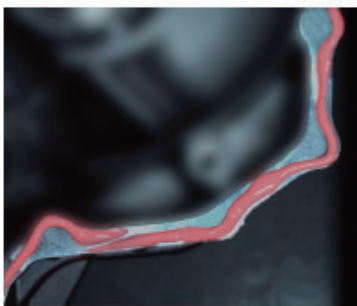

Original image

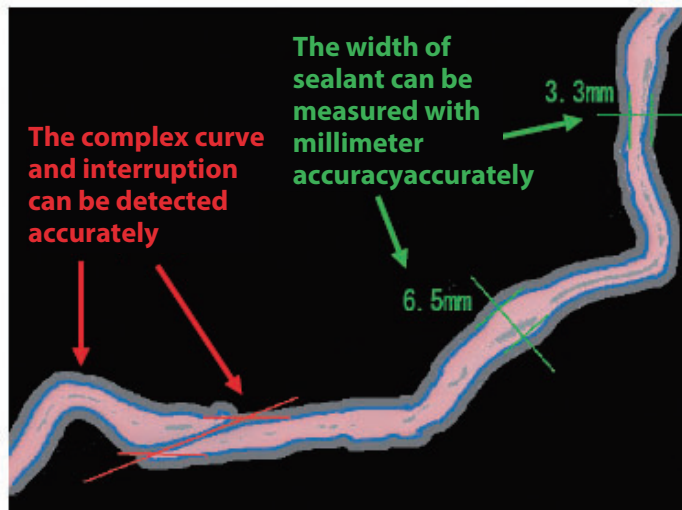

Parallel processing for high-speed inspection



In-line external inspection application on high-speed production lines

The FH Series provides various functions for in-line inspection requiring fast inspection speed.

Inspection flow example

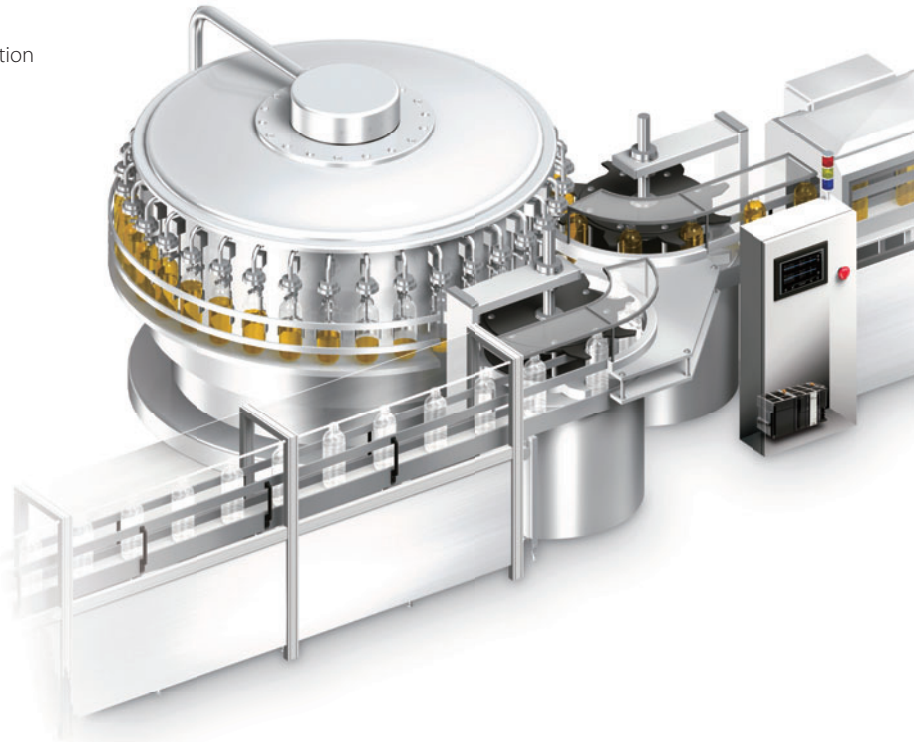
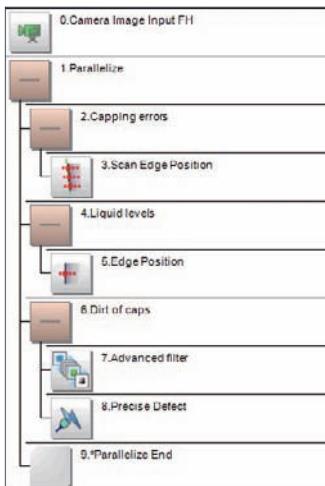

Trigger interval reduced by up to 75%

Generally, when multiple inspections are performed simultaneously, the waiting time until the next inspection occurs. Parallel processing on multi-core CPU greatly speeds up inspection by eliminating waiting time.

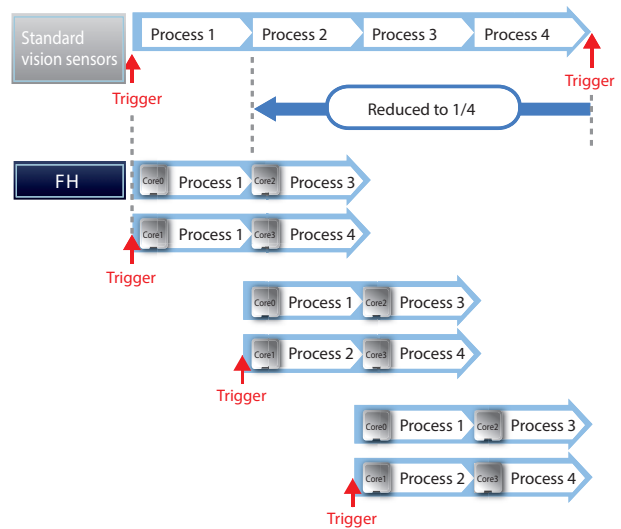
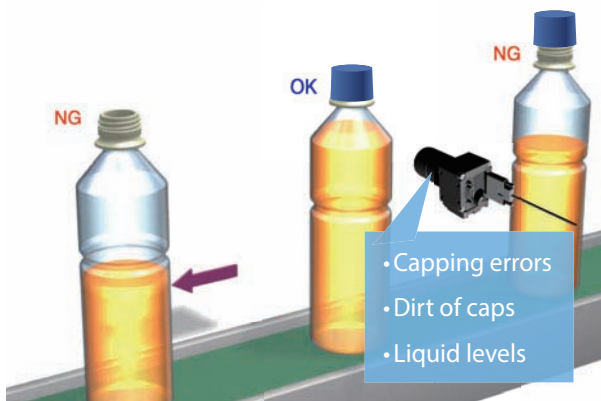

Multi-input function Continuous high-speed image capture

Higher speed from advanced image capture and parallel measurements

Each camera has its own image buffer for storing image data. This is separate from the main memory that is used for measurement processing. This allows for up to 256 frames* of continuous high-speed image capture even when the main memory is processing measurement data.

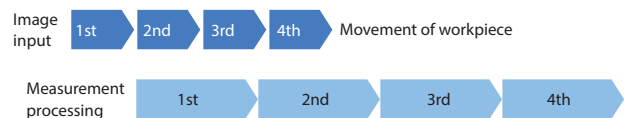

* The number of images that can be captured depends on the controller and the camera that is connected to it. Refer to the user's manual for details.

Image creation technology to maximize inspection capability

Real Color Sensing

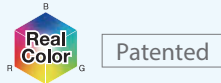

The FH Series features Omron's unique Real Color Sensing. High-speed processing using color information enables high-accuracy detection of edges and defects.



Edges are detected reliably even when the contrast between the background and subject is low.

Color segmentation processing

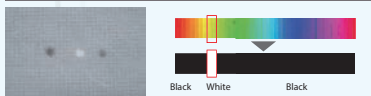

Color images taken by the camera are processed after being converted into black and white pixels. Based on minimum information, high speed processing is possible. Since color data is limited only to brightness, however, it takes a long time to make optical adjustments for extracting color features.

Color image processing

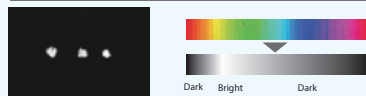

Color images are converted into 256 levels of black-and-white brightness and the contrasts of specific colors are enhanced. More precise, stable results can be produced compared to color segmentation. However, this method has difficulty in capturing subtle variations in color because all colors are converted into black-and-white brightness levels. Therefore, it is difficult to detect subtle changes in images with low contrast.

Real Color Sensing

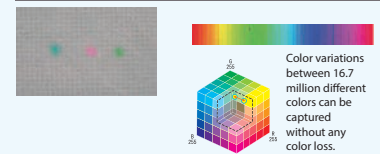

Different colors are represented as different positions in the 3D RGB space. Subtle variations in color can be recognized by representing them as distances between different color pixels comprising this space. Thus, scratches and dirt can be detected accurately even in images with low contrast.

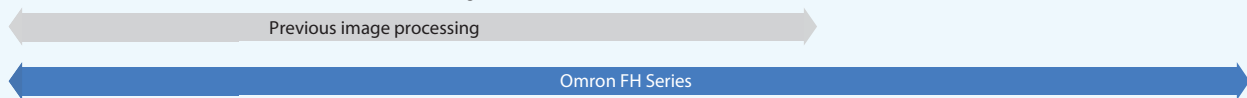

Stripe Removal Filter II

This processing item filters out the stripped pattern or other background. Reliable defect inspection can be achieved by extracting minute changes such as defects.

External appearance of bottle cap	
Unfiltered image	Image after Stripe Removal Filter
<p>Due to the stripes, inspection is possible only in the very center of the image. To inspect the entire surface, the cap must be rotated and many images must be taken.</p>	<p>Because even the defect at the edge of the image can be detected, the number of images that is required to inspect the entire cap is greatly reduced.</p>

Utilities

High-speed logging to save all images even during measurements

The CPU can perform parallel processing of measurements and image logging. With high-speed connection to a high-capacity (3 TB) HDD, all images on the high-speed line can be saved, which was previously difficult. Trend analysis of all saved images quickly isolates errors and facilitates countermeasures.

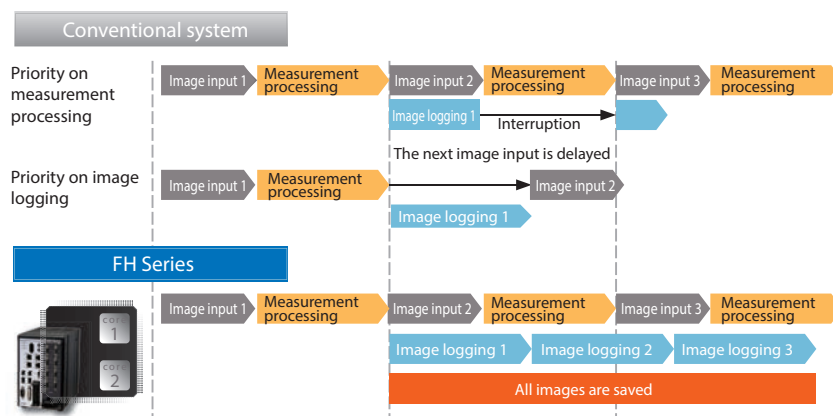

- *1. All images can be saved under the following conditions:
- 300,000-pixel camera x 1 unit
 - Measurement time: 20 ms
 - Images can be saved continuously for approx. 5 days when a 3 TB HDD is used (based on 8 hours of operation a day)

Issue

Since logging was not possible during measurement, the user had to choose either measurement or logging. Accordingly, not all images could be saved or image input triggers had to be delayed depending on the measurement trigger intervals.

Solution

Measurement and image logging are processed completely in parallel. As a result, you can save all images.

Robust to adverse conditions and easy to set



Track & Trace Applications

A single sensor can perform everything, from GS1 code reading to image inspection, which saves costs and space in Track & Trace application.

■ Inspection flow example

	0. Camera image input FH
	1. OCR
	2. Barcode



OCR is based on the Think & See technology, Omron's image sensing technology. See the details of Think & See.

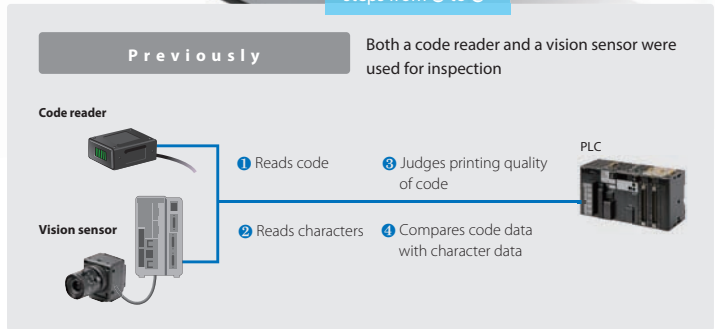

Stable reading of difficult-to-read characters

Printed characters can be too close to each other, and characters can be printed on curved surfaces. Even in these cases, stable reading is now possible.

Touching characters



Curved character strings



Easy installation with built-in dictionary

Many previous character reading methods required dictionary setup before usage, which was a tedious step. The built-in dictionary developed through Omron's long and rich experiences on FA sites includes a variety of fonts and possible character variations, eliminating the need of dictionary setup. You can also add non-conventional characters when special fonts are read.

Characters from most printers can be read, including dot and impact printers.

Approx. 80 different fonts



Hot printer



Inkjet printer



Thermal printer



Laser marker

Multi-line random processing

A single FH-3050/-1050 Controller can perform completely different inspections. Controllers installed for each inspection can be integrated into one, which reduces initial costs and save space.



Package insert detection

External inspection

GS1 code inspection

Easy commissioning of complex systems



Conveyor tracking application

The FH-1050/-3050 Controller provides the functionality to help you build the conveyor tracking system that is difficult to build because of complicated calibration. Calibration synchronized with conveyor control can be performed via EtherCAT.

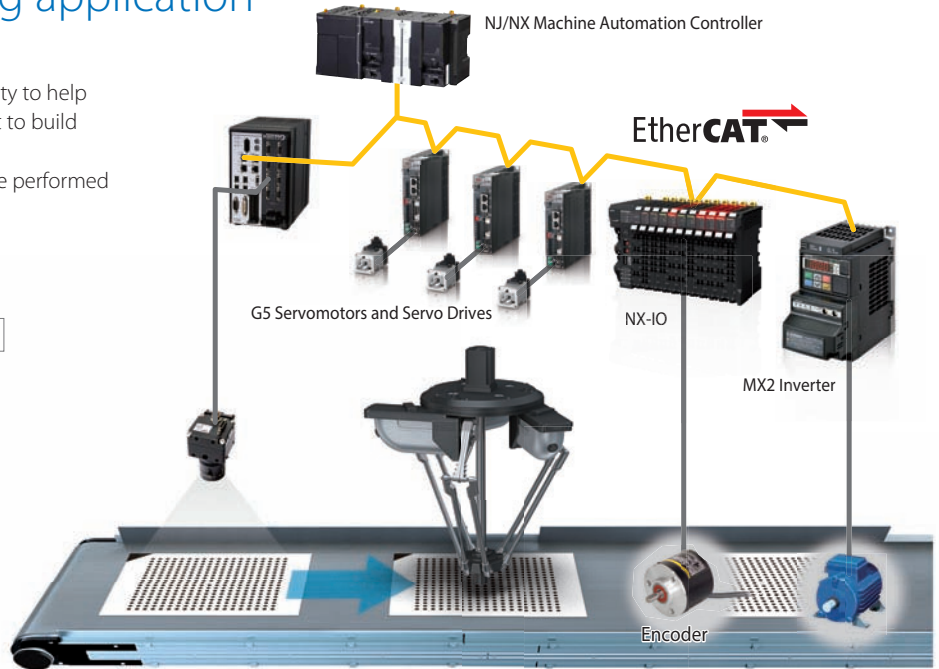

Calibration Wizard Patent Pending

Easy on-site calibration

To detect positions of workpieces carried on a conveyor and grip them with a robot hand, three different coordinate systems for the robot, conveyor, and vision must be aligned. With the FH Series, you can easily calibrate the entire system using a step-by-step wizard.

Calibration plate for wizard

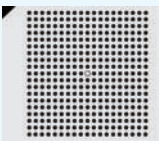

From the Sysmac Studio you can print the calibration plate in various sizes, from 30 mm to 2,000 mm, according to the size of the conveyor or camera field of view.

STEP1

Start the Calibration Wizard from the Sysmac Studio, and capture the image of the calibration plate.

STEP2

Move the calibration plate into the tracking area, and let the robot touch the target mark to automatically obtain the robot coordinates.

STEP3

The FH Controller automatically calculates by using the data including the conveyor travel distance. Calibration between the robot and FH Vision System is completed.

Removing duplication Patent Pending

Workpieces that overlap within more than one field of view are segregated and only inserted in the picking line once. You can eliminate the need to create the program for the machine controller to identify the same workpiece.

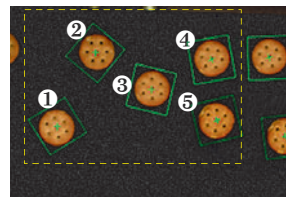

First shot

The positions and orientations of workpieces 1 to 5 are detected and added to the picking line.

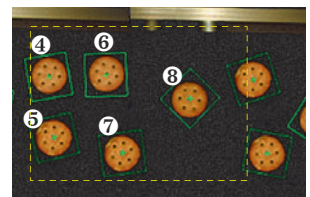

Next shot

Workpieces 4 to 8 are detected, but only the data of 6 to 8 is evaluated. The data of 4 and 5 is ignored because it was already added to the line.

Check ideal shooting intervals on panorama view Patented

The Conveyor Panorama Display Tool allows you to view the measurement trigger input intervals to ensure all workpieces can be detected.

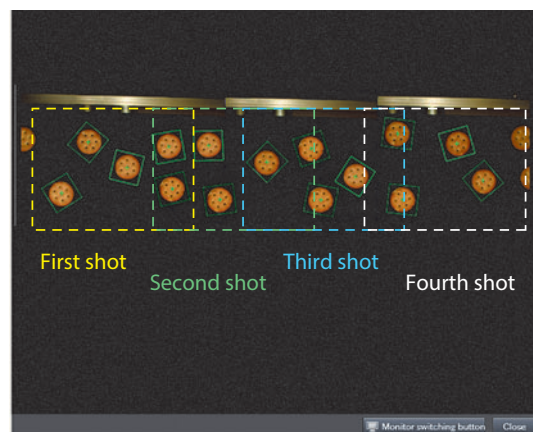

Reliable execution of complex inspection



External inspection application using multistage lighting

Defects that can be extracted only under the limited lighting condition can be inspected using multistage lighting.

■ Inspection flow example

1. Position Compensation
2. Camera Image Input FH
3. Position Compensation
4. Camera0 Measurement
5. Measurement Image Switching
6. Advanced filter
7. Scan Edge Width
8.
9. Camera1 Measurement
10. Measurement Image Switching
11. Advanced filter
12. Precise Defect
13.
14.

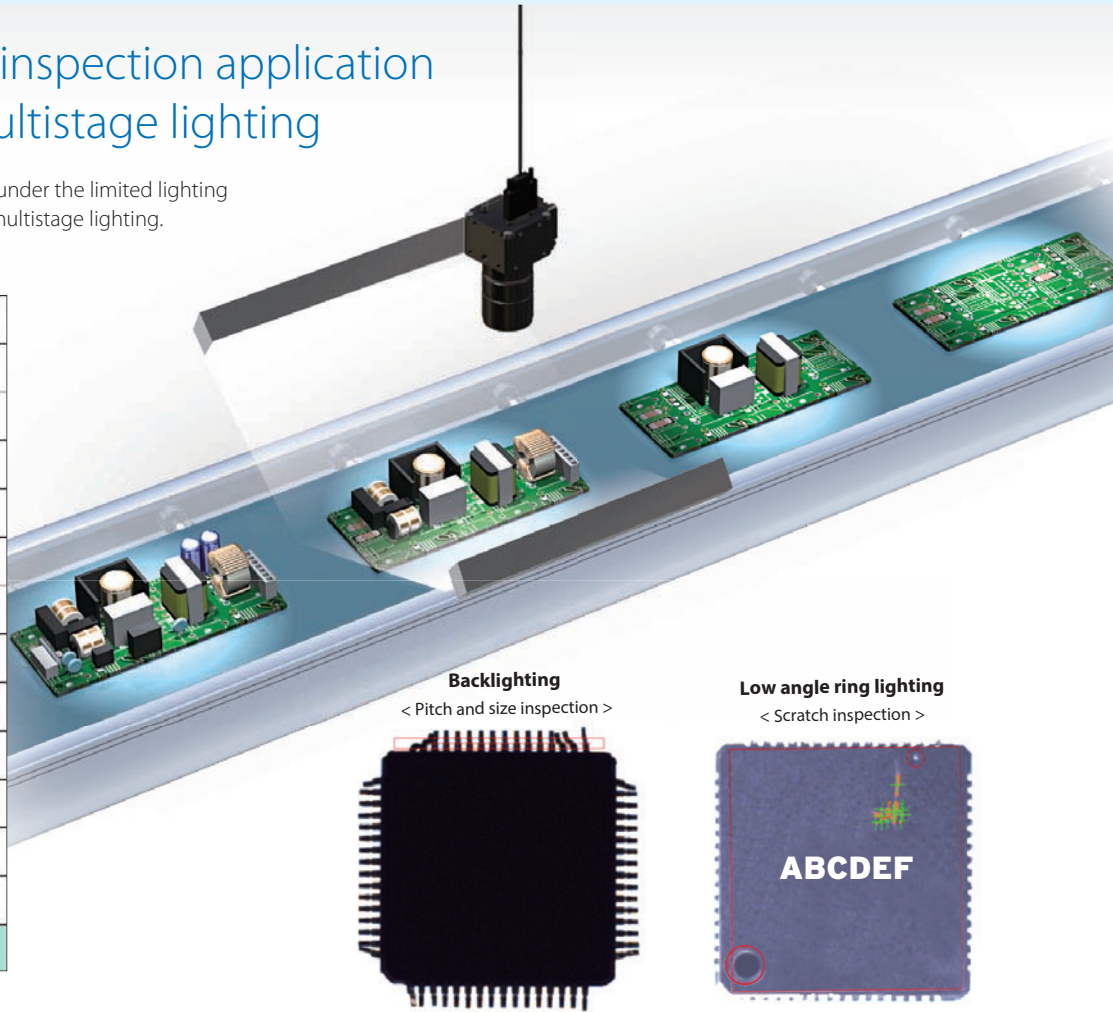

Light switching control

You can perform the inspection using images captured under different conditions by inputting multiple images in a inspection flow. The FH Series can capture images required for each inspection while changing the lighting conditions depending on inspection.

Easy light installation and setting

The use of camera-mount lighting controller eliminates the needs of power supply for lights and lighting cables, saving space and wiring. As the controller can switch lights and control brightness, you do not need to set from an external device.

Connect up to 32 lights for multistage control

You can perform multistage control with up to four lights connected to each electronic flash controller. If eight cameras are connected, up to 32 lights can be connected to the FH Controller.

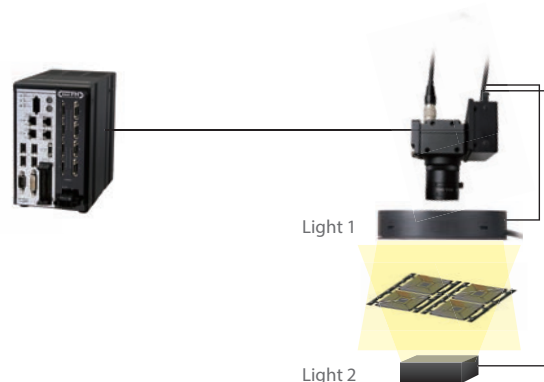

Automatic generation of measurement regions

A measurement region of any shape can be automatically set by specifying a part of the area to inspect. A region of a complex shape can be set with a few operations.

Specify a part of the area to inspect



A measurement region is automatically generated from the consecutive areas in the same color



Labeling filter

This filter uses label processing to output an extracted image that contains only the specified characteristic labels.

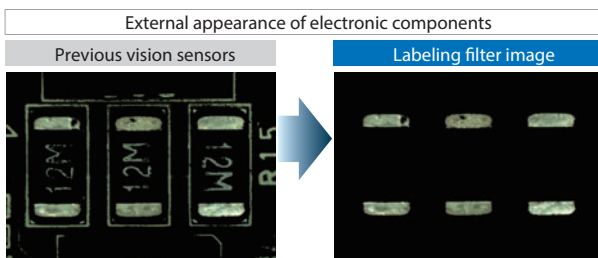

Extraction is possible only with color or brightness information.

Extraction of labels with specified areas or shapes is possible.



Custom filter

You can set the mask coefficients as required for these filters. The mask size can be up to 21 x 21. You can more flexibly set image smoothing, edge extractions, dilation, and erosion.

Example: Dilation/erosion in one direction

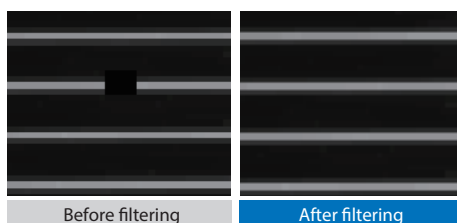

Filter coefficients

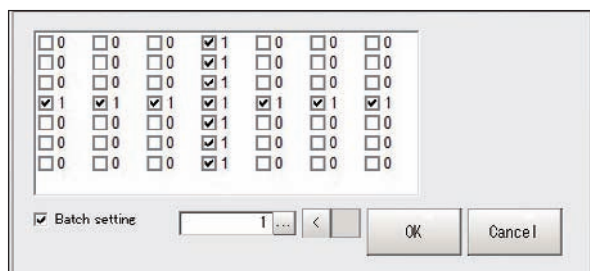

You can set the filter coefficients as required.



Calculations between images

You can perform arithmetic operations, bit operations, averaging, or maximum/minimum operations between two images.

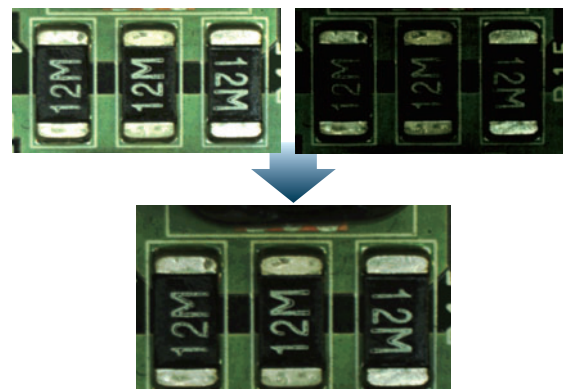

Example: You can get the average of two images that were taken under different conditions.



Brightness correct filter

This filter cuts out uneven lighting and changes in brightness caused by workpiece surface irregularities to make characteristic features stand out clearly.

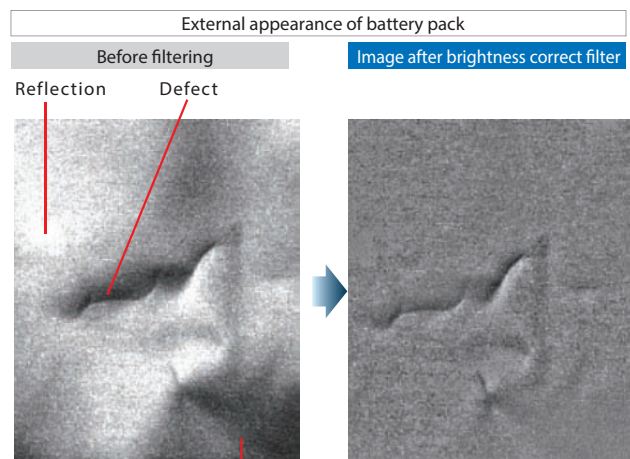

The wavy inconsistencies are judged as defects.

Uneven areas are removed so that only the defect appears in the inspection.

High-speed and high-precision stage alignment



Automatic precise calibration

Just execute the flow created for calibration to complete calibration for stages.

Calibration flow example

0. Camera Image Input FH
1. Camera 0
2. Shape Search III
3.
4. Camera 1
5. Camera Switching
6. Shape Search III
7.
8. Camera 2
12. Camera 3
16. Vision Master Calibration
17. Fieldbus Data Output
18. End
19. Stage Data



Optimized workpiece sampling

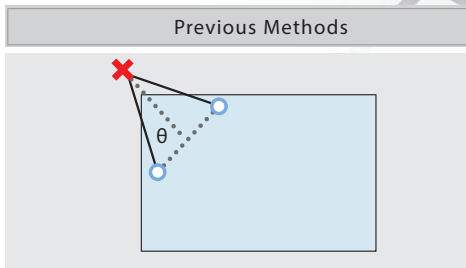

With the previous method, the user specifies the sampling points for calibration. If the rotation angle is not wide enough, the calibration accuracy is low.

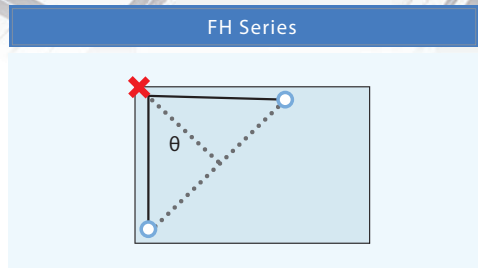

The FH Series automatically calculates sampling points that maximize the rotation angle by combining parallel movement with rotation movement within the travel range of the stage. High calibration accuracy that is not dependent on operator skill is assured.

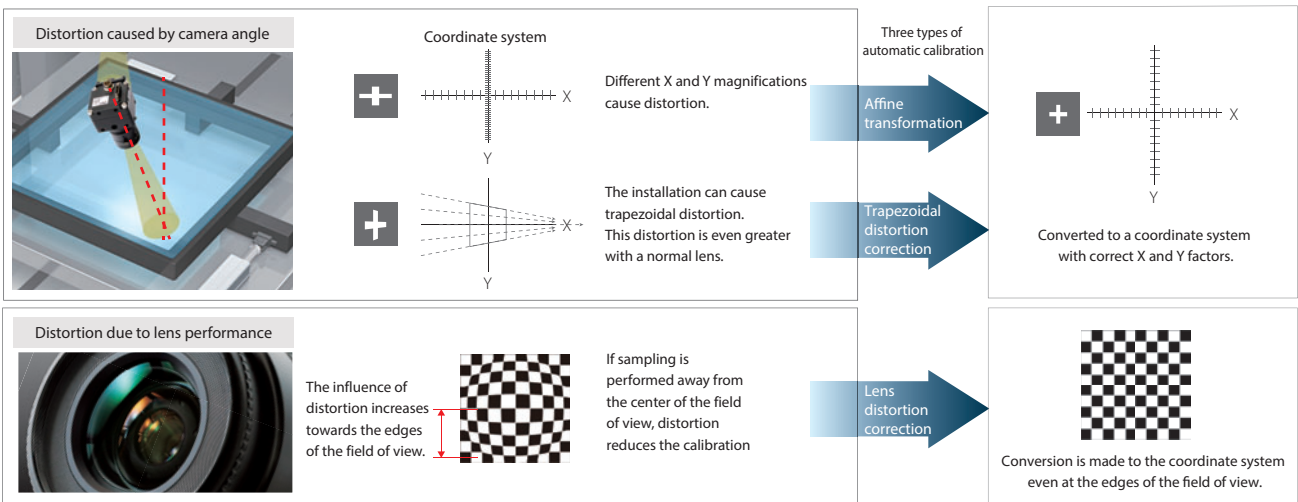

Stages Patent Pending

The single axis + Θ axis stages which are popular today as well as UWW stages can be used. The use of the same axis for both the handling axis of a manufacturing machine and the axis for positioning simplifies machine configuration.

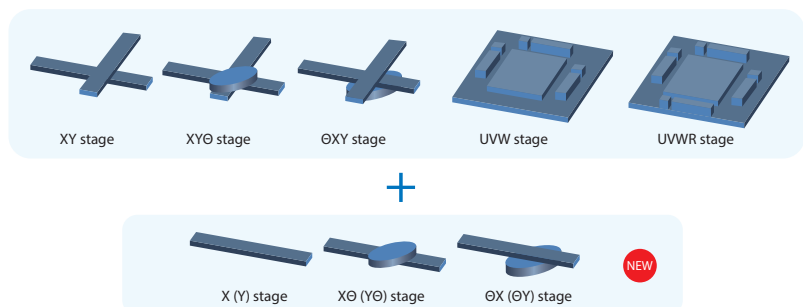

High-speed and high-precision positioning

High-precision positioning can be performed by referencing calibration parameters. Fast object detection and calculation by utilizing parallel processing increase machine speeds.

Alignment flow example

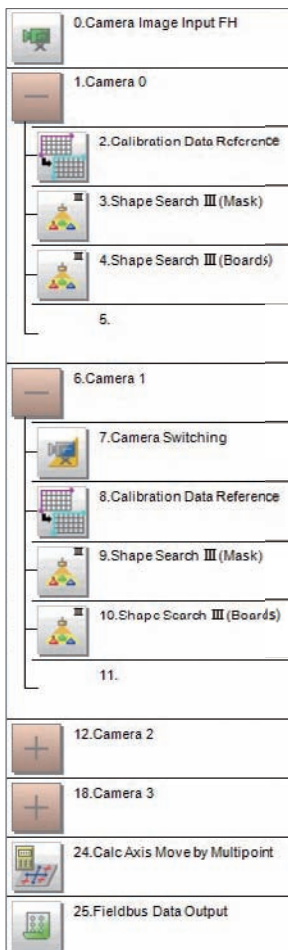

Parallel processing

Object detections using multiple cameras are performed in parallel. Pipeline processing enables fast detection without waiting.

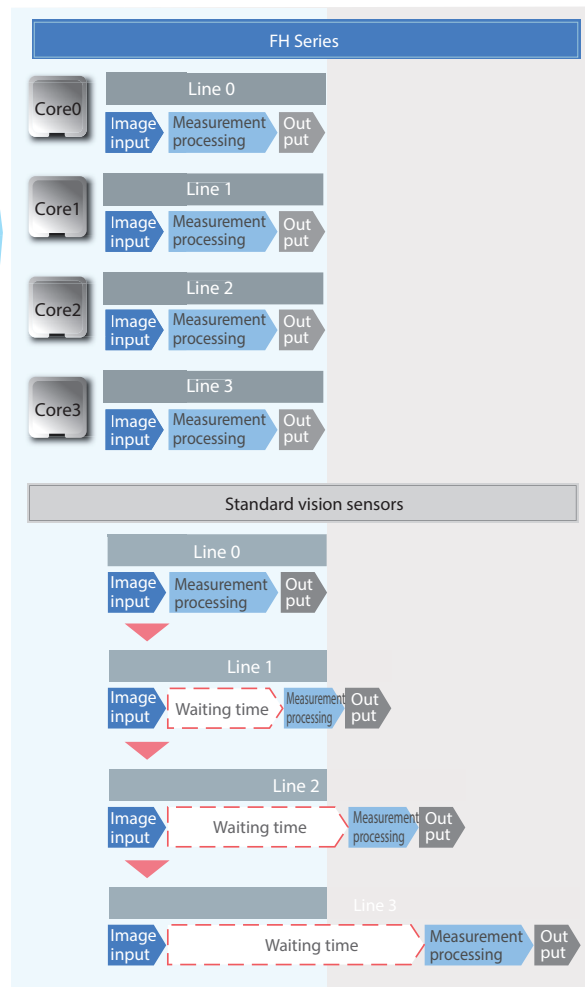

Available alignment methods

The processing items specialized for alignment calculations are provided, enabling flexible positioning of any workpiece.

• Alignment using positions and angles

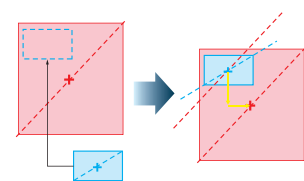

• Alignment with side measurements

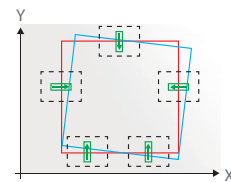

• Alignment using corresponding points

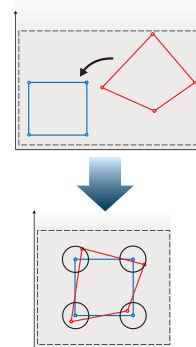

Data communications cycle 125 μ s

EtherCAT machine control network

You can use EtherCAT to connect NJ/NX Machine Automation Controllers and motion control G5 Servomotors and Servo Drives for high-speed control from workpiece detection to starting axis motion.

Communications cycle

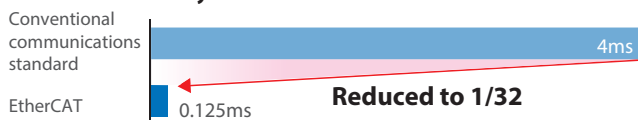

Time from trigger input to producing measurement results



Note: The times given above are typical times. They depend on parameter settings.

Versatile selection

You can select the best combination of camera and controller for your application. Software assets can be shared between controllers. This allows you to install devices with the capabilities you need, anywhere you need them.

Cameras

Choose the right camera to suit your resolution requirements. Easy-to-use cameras with built-in light are also available.

Resolution	Standard camera	High-speed camera	Rolling shutter camera	Camera with built-in light
12 Mpix	-	FH-S□12	-	-
5 Mpix/ 4 Mpix	FZ-S□5M	FH-S□04	FH-S□05R	-
2 Mpix	FZ-S□2M	FH-S□02	-	-
0.3 Mpix	FZ-S□	FH-S□	-	FZ-SQ□□□□



FH Controllers

Select a controller based on the required processing speed and network. All controllers can connect to any camera.

Model	Multi-line processing
FH-3050-□□	✓
FH-1050-□□	✓
FH-L550-□□	-



Lights

Omron offers a complete line-up of lights required for image processing. The use of the camera-mount lighting controller allows you to control lighting conditions from the FH Series, making machine configuration simple.

Description	LED	High-brightness LED
Camera-mount Lighting Controller	FLV-TCC	FL-TCC
Bar Light	FLV-BR	FL-BR
Direct Ring Light	FLV-DR	FL-DR
Low Angle Ring Light	FLV-DL	-
Coaxial Light	FLV-CL	-
Shadowless Light	FLV-FR/FP/FS/FQ	-
Spot Light	FLV-EP	-
Direct Back/Edge Type Ligh	FLV-DB/FB	-
Dome Light	FLV-DD	-

Refer to the Vision Accessory Catalog (Cat. No. Q198) for details.

Camera cables

The cable line-up includes handy bend-resistant cables and right-angle cables. Use the FZ-VSJ Cable Extension Unit for further extension of the cable.

Description	Model
Camera Cable	FZ-VS3 □□
Right-angle Camera Cable	FZ-VSL3□□
Bend-resistant Camera Cable	FZ-VSB3 □□
Bend-resistant Right-angle Camera Cable	FZ-VSLB3 □□
Cable Extension Unit	FZ-VSJ

Application Producer

This software enables you to install applications you created on the FH Series.

No. of connectable cameras	Fieldbus
8 max.	EtherNet/IP, EtherCAT
8 max.	EtherNet/IP, EtherCAT
4 max.	EtherNet/IP

Description	Model
DVD for installation	FH-AP1
Software license	FH-AP1L



EtherCAT

EtherNet/IP

Touch panel monitor

The touch panel monitor is optimized for the operation of the FH Series.

Description	Model
Touch Panel Monitor 12.1 inches	FH-MT12
DVI-Analog Conversion Cable for Touch Panel Monitor	FH-VMDA □□
USB Cable for Touch Panel Monitor	FH-VUAB □□

*RS-232C cables for long-distance connections are also available. Refer to Ordering Information for details.



Vision System FH-Series

Like or even more than the human eye

- A complete line-up of cameras for various applications
- Powerful controllers for fast and precise inspection and measurement
- Software for easy setting of various measurements



System configuratio

EtherCAT connections for FH series

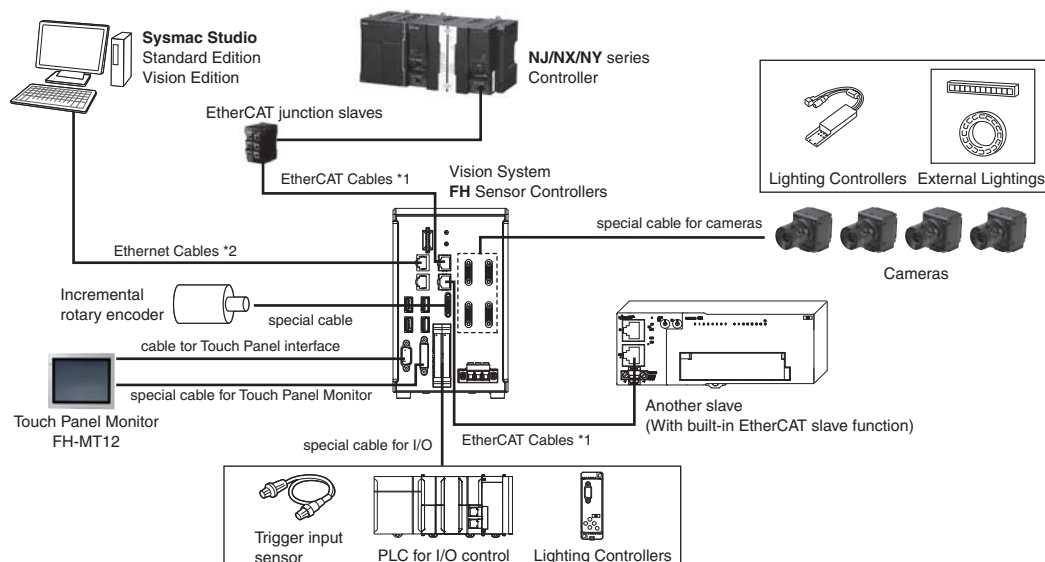

Example of the FH Sensor Controllers (4-camera type)



*1. To use STP (shielded twisted-pair) cable of category 5 or higher with double shielding (braiding and aluminum foil tape) for EtherCAT and RJ45 connector.
*2. To use STP (shielded twisted-pair) cable of category 5 or higher for Ethernet and RJ45 connector.

Ordering Information

FH Series Sensor Controllers

Item	CPU	No. of cameras	Output	Model
	High-speed Controllers (4 core)	2	NPN/PNP	FH-3050
		4	NPN/PNP	FH-3050-10
		8	NPN/PNP	FH-3050-20
	Standard Controllers (2 core)	2	NPN/PNP	FH-1050
		4	NPN/PNP	FH-1050-10
		8	NPN/PNP	FH-1050-20
	Lite Controllers (2 core)	2	NPN/PNP	FH-L550
		4	NPN/PNP	FH-L550-10

Cameras

Item	Descriptions	Color / Monochrome	Image Acquisition Time *1	Model	
	High-speed Digital CMOS Cameras (Lens required)	12 million pixels (Up to four cameras can be connected to one Controller. Up to eight cameras other than 12 million-pixel cameras can be connected to a FH-3050-20 or a FH-1050-20.)	Color	25.7 ms *2	FH-SC12
		Monochrome	FH-SM12		
	High-speed Digital CMOS Cameras (Lens required)	4 million pixels	Color	8.5 ms *2	FH-SC04
		Monochrome	FH-SM04		
		2 million pixels	Color	4.6 ms *2	FH-SC02
		Monochrome	FH-SM02		
		300,000 pixels	Color	3.3 ms	FH-SC
		Monochrome	FH-SM		
	Digital CMOS Cameras (Lens required)	5 million pixels	Color	71.7ms	FH-SC05R
		Monochrome	FH-SM05R		
	Digital CCD Cameras (Lens required)	5 million pixels	Color	62.5 ms	FZ-SC5M2
		Monochrome	FZ-S5M2		
		2 million pixels	Color	33.3 ms	FZ-SC2M
		Monochrome	FZ-S2M		
		300,000 pixels	Color	12.5 ms	FZ-SC
		Monochrome	FZ-S		
	High-speed Digital CCD Cameras (Lens required)	300,000 pixels	Color	4.9 ms	FZ-SHC
		Monochrome	FZ-SH		
	Small Digital CCD Cameras (Lenses for small camera required)	300,000-pixel flat type	Color	12.5 ms	FZ-SFC
		Monochrome	FZ-SF		
		300,000-pixel pen type	Color	12.5 ms	FZ-SPC
		Monochrome	FZ-SP		
	Intelligent Compact Digital CMOS Camera (Camera + Manual Focus Lens + High power Lighting)	Narrow view	Color	16.7 ms	FZ-SQ10F
		Standard view	Color		FZ-SQ050F
		Wide View (long-distance)	Color		FZ-SQ100F
		Wide View (short-distance)	Color		FZ-SQ100N

*1 The image acquisition time does not include the image conversion processing time of the sensor controller.
The camera image input time varies depending on the sensor controller model, number of cameras, and camera settings.
Check before you use the camera.

*2 Frame rate in high speed mode when the camera is connected using two camera cables. For other conditions, please refer to the chart below.

Model		FH-SM02	FH-SC02	FH-SM04	FH-SC04	FH-SM12	FH-SC12
Image Acquisition Time	2 Cables *1	High Speed Mode *2	4.6ms	8.5ms	25.7ms		
		Standard Mode	9.7ms	17.9ms	51.3ms		
	1 Cables	High Speed Mode *2	9.2ms	17.0ms	51.3ms		
		Standard Mode	19.3ms	35.8ms	102.0ms		

*1 Two Camera ports of the controller are used per one camera.

*2 Up to 5 m Camera Cable length.

Camera Cables

Item	Descriptions	Model *3
	Camera Cable Cable length: 2 m, 3 m, 5m, or 10 m *2	FZ-VS3 □M
	Bend resistant Camera Cable Cable length: 2 m, 3 m, 5m, or 10 m *2	FZ-VSB3 □M
	Right-angle Camera Cable *1 Cable length: 2 m, 3 m, 5m, or 10 m *2	FZ-VSL3 □M
	Bend resistant Right-angle Camera Cable *1 Cable length: 2 m, 3 m, 5 m, or 10 m *2	FZ-VSLB3 □M
	Long-distance Camera Cable Cable length: 15 m *2	FZ-VS4 15M
	Long-distance Right-angle Camera Cable *1 Cable length: 15 m *2	FZ-VSL4 15M
	Cable Extension Unit Up to two Extension Units and three Cables can be connected. (Maximum cable length: 45 m *2)	FZ-VSJ

*1 This Cable has an L-shaped connector on the Camera end.

*2 The maximum cable length depends on the Camera being connected, and the model and length of the Cable being used. For further information, please refer to the "Cameras / Cables Connection Table" and "Maximum Extension Length Using Cable Extension Units FZ-VSJ table".
When a high-speed Digital CMOS camera FH-S□02/-S□04/-S□12 is used in the high speed mode of transmission speed, two camera cables are required.

*3 Insert the cables length into □ in the model number as follows. 2 m = 2, 3 m = 3, 5 m = 5, 10 m = 10

Cameras / Cables Connection Table

Type of camera	Model	Cable length	High-speed Digital CMOS cameras							Digital CMOS Camera
			300,000-pixel	2 million-pixel		4 million-pixel		12 million-pixel		5 megapixel camera
			FH-SM/SC	FH-SM02/SC02		FH-SM04/SC04		FH-SM12/SC12		FH-SC05R/SM05R
			—	High speed mode of transmission speed select	Standard mode of transmission speed select	High speed mode of transmission speed select	Standard mode of transmission speed select	High speed mode of transmission speed select	Standard mode of transmission speed select	—
Camera Cables Right-angle camera cables	FZ-VS3 FZ-VSL3	2 m	Yes	Yes	Yes	Yes	Yes	Yes	Yes	Yes
		3 m	Yes	Yes	Yes	Yes	Yes	Yes	Yes	Yes
		5 m	Yes	Yes	Yes	Yes	Yes	Yes	Yes	Yes
		10 m	Yes	No	Yes	No	Yes	No	Yes	Yes
Bend resistant camera cables Bend resistant Right-angle Camera Cable	FZ-VSB3 FZ-VSLB3	2 m	Yes	Yes	Yes	Yes	Yes	Yes	Yes	Yes
		3 m	Yes	Yes	Yes	Yes	Yes	Yes	Yes	Yes
		5 m	Yes	Yes	Yes	Yes	Yes	Yes	Yes	Yes
		10 m	Yes	No	Yes	No	Yes	No	Yes	Yes
Long-distance camera cable Long-distance right-angle camera cable	FZ-VS4 FZ-VSL4	15 m	Yes	No	Yes	No	Yes	No	Yes	Yes

Type of camera	Model	Cable length	Digital CCD cameras			Small digital CCD cameras Pen type / flat type	High-speed Digital CCD cameras	Intelligent Compact Digital CMOS Camera
			300,000-pixel	2 million-pixel	5 million-pixel			
			FZ-S/SC	FZ-S2M/SC2M	FZ-S5M2/SC5M2	FZ-SF/SFC FZ-SP/SPC	FZ-SH/SHC	FZ-SQ□
Camera Cables Right-angle camera cables	FZ-VS3 FZ-VSL3	2 m	Yes	Yes	Yes	Yes	Yes	Yes
		3 m	Yes	Yes	Yes	Yes	Yes	Yes
		5 m	Yes	Yes	Yes	Yes	Yes	Yes
		10 m	Yes	Yes	No	Yes	Yes	Yes
Bend resistant camera cables Bend resistant Right-angle Camera Cable	FZ-VSB3 FZ-VSLB3	2 m	Yes	Yes	Yes	Yes	Yes	Yes
		3 m	Yes	Yes	Yes	Yes	Yes	Yes
		5 m	Yes	Yes	Yes	Yes	Yes	Yes
		10 m	Yes	Yes	No	Yes	Yes	Yes
Long-distance camera cable Long-distance right-angle camera cable	FZ-VS4 FZ-VSL4	15 m	Yes	Yes	No	Yes	Yes	Yes

Maximum Extension Length Using Cable Extension Units FZ-VSJ

Item	Model	Transmission speed (*1)	No. of CH used for connection (*2)	Maximum cable length using 1 Camera Cable (*1)	Max. number of connectable Extension Units	Using Cable Extension Units FZ-VSJ						
						Max. cable length	Connection configuration					
High-speed Digital CMOS Cameras	FH-SM/SC FH-SM02/SC02 FH-SM04/SC04 FH-SM12/SC12	---	---	15 m (Using FZ-VS4/VSL4)	2	45 m	[Configuration 1] Camera cable: 15 m × 3 Extension Unit: 2					
							Standard	1	15 m (Using FZ-VS4/VSL4)	2	45 m	[Configuration 1] Camera cable: 15 m × 3 Extension Unit: 2
								2	15 m (Using FZ-VS4/VSL4)	4 (*3)	45 m	[Configuration 2] Camera cable: 15 m × 6 Extension Unit: 4
							High speed	1	5 m (Using FZ-VS□/VSL□)	2	15 m	[Configuration 3] Camera cable: 5 m × 3 Extension Unit: 2
2	5 m (Using FZ-VS□/VSL□)	4 (*3)	15 m	[Configuration 4] Camera cable: 5 m × 6 Extension Unit: 4								
Digital CMOS Cameras	FH-SC05R FH-SM05R	---	---	15m (Using FZ-VS4/VSL4)	2	45 m	[Configuration 1] Camera cable: 15 m × 3 Extension Unit: 2					
Digital CCD Cameras	FZ-S/SC FZ-S2M/SC2M FZ-S5M2/SC5M2	---	---	15 m (Using FZ-VS4/VSL4)	2	45 m	[Configuration 1] Camera cable: 15 m × 3 Extension Unit: 2					
							[Configuration 3] Camera cable: 5 m × 3 Extension Unit: 2					
Small Digital CCD Cameras Flat type/ Pen type	FZ-SF/SFC FZ-SP/SPC	---	---	15 m (Using FZ-VS4/VSL4)	2	45 m	[Configuration 1] Camera cable: 15 m × 3 Extension Unit: 2					
High-speed Digital CCD Cameras	FZ-SH/SHC	---	---	15 m (Using FZ-VS4/VSL4)	2	45 m	[Configuration 1] Camera cable: 15 m × 3 Extension Unit: 2					
Intelligent Compact Digital CMOS Camera	FZ-SQ□	---	---	15 m (Using FZ-VS4/VSL4)	2	45 m	[Configuration 1] Camera cable: 15 m × 3 Extension Unit: 2					

*1 The FH-S□□□ enables switching between standard and high speed modes. In high speed mode, images can be transferred approximately two times faster than in standard mode, but the connectable cable length will be shorter.
 *2 The FH-S□□□ has two channels to connect Camera Cables. Connection to two channels makes image transfer two times faster than connection to one channel: high speed mode using two channels can transfer approximately four times as many images as standard mode using one channel.
 *3 Each channel can be used to connect up to two Cable Extension Units: up to four extension units, two channels x two units, can be connected by using two channels.

Connection Configuration

	Connection configuration using the maximum length of Camera Cables	Remarks
Configuration 1		
Configuration 2		
Configuration 3		
Configuration 4		

*4 Select the Camera Cables between the Controller and Extension Unit, between the Extension Units, and between the Extension Unit and Camera according to the connected Camera.
Different types or lengths of Camera Cables can be used for (1), (2), and (3) as well as for (4), (5), and (6). However, the type and length of Camera Cable (1) must be the same as those of Camera Cable (4), (2) must be the same as (5), and (3) must be the same as (6).

Touch Panel Monitor

Item	Descriptions	Model
	Touch Panel Monitor 12.1 inches For FH Sensor Controllers *	FH-MT12

* FH Series Sensor Controllers version 5.32 or higher is required.

Touch Panel Monitor Cables

Item	Descriptions	Model
	DVI-Analog Conversion Cable for Touch Panel Monitor Cable length: 2 m, 5 m or 10 m	FH-VMDA □M *1
	RS-232C Cable for Touch Panel Monitor Cable length: 2 m, 5 m or 10 m	XW2Z-□□□PP-1 *2
	USB Cable for Touch Panel Monitor Cable length: 2 m or 5 m	FH-VUAB □M *1

*1 Insert the cables length into □ in the model number as follows. 2 m = 2, 5 m = 5, 10 m = 10

*2 Insert the cables length into □□□ in the model number as follows. 2 m = 200, 5 m = 500, 10 m = 010.

A video signal cable and an operation signal cable are required to connect the Touch Panel Monitor.

Signal	Cable	2 m	5 m	10 m
Video signal	DVI-Analog Conversion Cable	Yes	Yes	Yes
Touch panel operation signal	USB Cable	Yes	Yes	No
	RS-232C Cable	Yes	Yes	Yes

Parallel I/O Cables/Encoder Cable

Item	Descriptions	Model
	Parallel I/O Cable *1 Cable length: 2m, 5m or 15m	XW2Z-S013-□ *2
	Parallel I/O Cable for Connector-terminal Conversion Unit *1 Cable length: 0.5 m, 1 m, 1.5 m, 2 m, 3 m, 5 m Connector-Terminal Block Conversion Units can be connected (Terminal Blocks Recommended Products: OMRON XW2R-□□34G-T)	XW2Z-□□□EE *3
	Connector-Terminal Block Conversion Units, General-purpose devices	XW2R-□□34GD-T *4
	Encoder Cable for line-driver Cable length: 1.5 m	FH-VR 1.5M

*1 2 Cables are required for all I/O signals.





*2 Insert the cables length into □ in the model number as follows. 2 m = 2, 5 m = 5, 15 m = 15

*3 Insert the cables length into □□□ in the model number as follows. 0.5 m = 050, 1 m = 100, 1.5 m = 150, 2 m = 200, 3 m = 300, 5 m = 500

*4 Insert the wiring method into □ in the model number as follows. Phillips screw = J, Slotted screw (rise up) = E, Push-in spring = P
Refer to the XW2R Series catalog (Cat. No. G077) for details.

Parallel Converter Cable

When you change to connect the F series, FZ5 series, or FZ5-L series to FH series Sensor Controller, you can convert by using the appropriate parallel converter cable of FH-VPX series under the usable condition.





Item	Applicable Model		Usable Condition	Model
	FZ□ series		<ul style="list-style-type: none"> Do not use RESET signal. * Use with COMIN and COMUT are same power source. 	FH-VPX-FZ
	FZ□-L35x series		<ul style="list-style-type: none"> Do not use RESET signal. * 	FH-VPX-FZL
	F160 series	F160-C10	<ul style="list-style-type: none"> Do not use RESET signal. * Use with COMIN and COMOUT are same power source. Do not use DI5 and DI6. 	FH-VPX-F160
	F210 series	F210-C10	<ul style="list-style-type: none"> Do not use RESET signal. * Use with COMIN and COMOUT are same power source. Do not use DI8 and DI9. 	FH-VPX-F210
		F210-C10-ETN		
F500 series	F500-C10			

* Even if RESET signal cannot be use by conversion, conversion is possible to convert satisfying other usable condition.

Note: Cannot be used for the F160-C10CP/-C10CF.

Recommended EtherCAT and EtherNet/IP Communications Cables

Use Straight STP (shielded twisted-pair) cable of category 5 or higher with double shielding (braiding and aluminum foil tape) for EtherCAT.
Use Straight or cross STP (shielded twisted-pair) cable of category 5 or higher for EtherNet/IP.

Item	Descriptions			Model
	For EtherCAT	Cable with Connectors on Both Ends (RJ45/RJ45) Standard RJ45 plugs type *1 Wire Gauge and Number of Pairs: AWG26, 4-pair Cable Cable Sheath material: LSZH *2 Cable color: Yellow *3	Cable length: 0.3 m	XS6W-6LSZH8SS30CM-Y
			Cable length: 0.5 m	XS6W-6LSZH8SS50CM-Y
			Cable length: 1 m	XS6W-6LSZH8SS100CM-Y
			Cable length: 2 m	XS6W-6LSZH8SS200CM-Y
			Cable length: 3 m	XS6W-6LSZH8SS300CM-Y
			Cable length: 5 m	XS6W-6LSZH8SS500CM-Y
	For EtherCAT	Cable with Connectors on Both Ends (RJ45/RJ45) Rugged RJ45 plugs type *1 Wire Gauge and Number of Pairs: AWG22, 2-pair Cable Cable color: Light blue	Cable length: 0.3 m	XS5W-T421-AMD-K
			Cable length: 0.5 m	XS5W-T421-BMD-K
			Cable length: 1 m	XS5W-T421-CMD-K
			Cable length: 2 m	XS5W-T421-DMD-K
			Cable length: 5 m	XS5W-T421-GMD-K
			Cable length: 10 m	XS5W-T421-JMD-K
	For EtherCAT	Cable with Connectors on Both Ends (M12 Straight/M12 Straight) Shield Strengthening Connector cable *4 M12/Smartclick Connectors Wire Gauge and Number of Pairs: AWG22, 2-pair Cable Cable color: Black	Cable length: 0.5 m	XS5W-T421-BM2-SS
			Cable length: 1 m	XS5W-T421-CM2-SS
			Cable length: 2 m	XS5W-T421-DM2-SS
			Cable length: 3 m	XS5W-T421-EM2-SS
			Cable length: 5 m	XS5W-T421-GM2-SS
			Cable length: 10 m	XS5W-T421-JM2-SS
	For EtherCAT	Cable with Connectors on Both Ends (M12 Straight/RJ45) Shield Strengthening Connector cable *4 M12/Smartclick Connectors Rugged RJ45 plugs type Wire Gauge and Number of Pairs: AWG22, 2-pair Cable Cable color: Black	Cable length: 0.5 m	XS5W-T421-BMC-SS
			Cable length: 1 m	XS5W-T421-CMC-SS
			Cable length: 2 m	XS5W-T421-DMC-SS
			Cable length: 3 m	XS5W-T421-EMC-SS
			Cable length: 5 m	XS5W-T421-GMC-SS
			Cable length: 10 m	XS5W-T421-JMC-SS
--	For EtherCAT and EtherNet/IP	Wire Gauge and Number of Pairs: AWG24, 4-pair Cable	Cables	Hitachi Metals, Ltd. NETSTAR-C5E SAB 0.5 × 4P *5
--				Kuramo Electric Co. KETH-SB *5
--				SWCC Showa Cable Systems Co. FAE-5004 *5
--			RJ45 Connectors	Panduit Corporation MPS588-C *5
--		Wire Gauge and Number of Pairs: AWG22, 2-pair Cable	Cables	Kuramo Electric Co. KETH-PSB-OMR *6
--				JMACS Japan Co.,Ltd. PNET/B *6
			RJ45 Assembly Connector	OMRON XS6G-T421-1 *6
--	For EtherNet/IP	Wire Gauge and Number of Pairs: 0.5 mm, 4-pair Cable	Cables	Fujikura Ltd. F-LINK-E 0.5mm × 4P *7
--				RJ45 Connectors

Note: Please be careful while cable processing, for EtherCAT, connectors on both ends should be shield connected and for EtherNet/IP, connectors on only one end should be shield connected.

*1 Standard type cables length 0.2, 0.3, 0.5, 1, 1.5, 2, 3, 5, 7.5, 10, 15 and 20 m are available.

Rugged type cables length 0.3, 0.5, 1, 2, 3, 5, 10 and 15 m are available.

For details, refer to Cat.No.G019.

*2 The lineup features Low Smoke Zero Halogen cables for in-cabinet use and PUR cables for out-of-cabinet use. Although the LSZH cable is single shielded, its communications and noise characteristics meet the standards.

*3 Cables colors are available in blue, yellow, or Green.

*4 For details, contact your OMRON representative.

*5 We recommend you to use above cable for EtherCAT and EtherNet/IP, and RJ45 Connector together.

*6 We recommend you to use above cable for EtherCAT and EtherNet/IP, and RJ45 Assembly Connector together.

*7 We recommend you to use above cable For EtherNet/IP and RJ45 Connectors together.

Automation Software Sysmac Studio

Please purchase a DVD and licenses the first time you purchase the Sysmac Studio. DVDs and licenses are available individually. The license does not include the DVD.

Item	Specifications			Model
		Number of licenses	Media	
Sysmac Studio Standard Edition Ver.1.□□	The Sysmac Studio is the software that provides an integrated environment for setting, programming, debugging and maintenance of machine automation controllers including the NJ/NX-series CPU Units, NY-series Industrial PC, EtherCat Slave, and the HMI. Sysmac Studio runs on the following OS. Windows 7 (32-bit/64-bit version) / Windows 8 (32-bit/64-bit version) / Windows 8.1 (32-bit/64-bit version) / Windows 10 (32bit/64bit version) This software provides functions of the Vision Edition. Refer to Sysmac Catalog (P072) for details such as supported models and functions.	-- (Media only)	DVD *1	SYSMAC-SE200D
		1 license	—	SYSMAC-SE201L
		3 license	—	SYSMAC-SE203L
		10 license	—	SYSMAC-SE210L
		30 license	—	SYSMAC-SE230L
		50 license	—	SYSMAC-SE250L
Sysmac Studio Vision Edition Ver.1.□□ *2 *3	Sysmac Studio Vision Edition is a limited license that provides selected functions required for FH-series/FQ-M-series Vision Sensor settings.	1 license	—	SYSMAC-VE001L
Sysmac Studio Robot Additional Option *3	Sysmac Studio Robot Additional Option is a license to enable the Vision & Robot integrated simulation.	1 license	—	SYSMAC-RA401L

Note: 1. Site licenses are available for users who will run Sysmac Studio on multiple computers. Ask your OMRON sales representative for details.
2. Sysmac Studio version 1.07 or higher supports the FH Series. Sysmac Studio does not support the FH-L550/-L550-10.

*1 The same media is used for both the Standard Edition and the Vision Edition.
*2 With the Vision Edition, you can use only the setup functions for FH-series/FQ-M-series Vision Sensors.
*3 This product is a license only. You need the Sysmac Studio Standard Edition DVD media to install it.













Development Environment

Please purchase a CD-ROM and licenses the first time you purchase the Application Producer. CD-ROMs and licenses are available individually. The license does not include the CD-ROM.

Product	Specifications			Model
		Number of Model Standards licenses	Media	
Application Producer	Software components that provide a development environment to further customize the standard controller features of the FH Series. System requirements: • CPU: Intel Pentium Processor (SSE2 or higher) • OS: Windows 7 Professional (32/64bit) or Enterprise(32/64bit) or Ultimate (32/64bit), Windows 8 Pro(32/64bit) or Enterprise(32/64bit), Windows 8.1 Pro(32/64bit) or Enterprise(32/64bit) • .NET Framework: .NET Framework 3.5 or higher • Memory: At least 2 GB RAM Available disk space: At least 2 GB • Browser: Microsoft® Internet Explorer 6.0 or later • Display: XGA (1024 × 768), True Color (32-bit) or higher • Optical drive: CD/DVD drive The following software is required to customize the software: Microsoft® Visual Studio® 2010 Professional or Microsoft® Visual Studio® 2008 Professional or Microsoft® Visual Studio® 2012 Professional	-- (Media only)	CD-ROM	FH-AP1
		1 license	—	FH-AP1L

FH-Series











Accessories

Item	Descriptions			Model
	LCD Monitor 8.4 inches			FZ-M08
	LCD Monitor Cable When you connect a LCD Monitor FZ-M08 to FH sensor controller, please use it in combination with a DVI-I -RGB Conversion Connector FH-VMRGB.		2 m	FZ-VM 2M
			5 m	FZ-VM 5M
	DVI-I -RGB Conversion Connector			FH-VMRGB
	USB Memory		2 GB	FZ-MEM2G
			8 GB	FZ-MEM8G
	SD Card		2 GB	HMC-SD291
			4 GB	HMC-SD491
	Display/USB Switcher			FZ-DU
—	Mouse Recommended Products Driverless wired mouse (A mouse that requires the mouse driver to be installed is not supported.)			---
	EtherCAT junction slaves		3 port	Current consumption: 0.08 A
			6 port	Current consumption: 0.17 A
	Industrial Switching Hubs for EtherNet/IP and Ethernet		3 port	Failure detection: None
			5 port	Failure detection: None
			5 port	Failure detection: Supported
—	Calibration Plate			FZD-CAL
	DIN rail mounting bracket			FH-XDM-L
	Common items related to DIN rail (for FH-L550/-L550-10)		DIN 35mm rail	PHOENIX CONTACT
				<ul style="list-style-type: none"> Length: 75.5/95.5/115.5/200 cm Height: 7.5mm Material: Iron Surface: Conductive
			End plate	PHOENIX CONTACT
				<ul style="list-style-type: none"> Length: 75.5/95.5/115.5/200 cm Height: 15mm Material: Iron Surface: Conductive
—	External Lighting			—
	Lighting Controller (Required to control external lighting from a Controller)		For FLV-Series	Camera Mount Lighting Controller
				Analog Lighting Controller
			For FL-Series	Camera Mount Lighting Controller
	For Intelligent Compact Digital CMOS Camera			Mounting Bracket
				Mounting Brackets
				Polarizing Filter Attachment
—	Mounting Bracket for FZ-S□			FZ-S-XLC
	Mounting Bracket for FZ-S□2M			FZ-S2M-XLC
	Mounting Bracket for FZ-SH□			FZ-SH-XLC
	Mounting Bracket for FH-S□, FZ-S□5M2			FH-SM-XLC
	Mounting Bracket for FH-S□12			FH-SM12-XLC
M42 - F Mount Conversion Adapter			FH-ADF/M42-10	









* Refer to the Vision Accessory Catalog (Cat. No. Q198) for details.

Lenses







C-mount Lens for 1/3-inch image sensor (Recommend: FZ-S□/FZ-SH□/FH-S□)

Model	3Z4S-LE SV-03514V	3Z4S-LE SV-04514V	3Z4S-LE SV-0614V	3Z4S-LE SV-0813V	3Z4S-LE SV-1214V	3Z4S-LE SV-1614V	3Z4S-LE SV-2514V	3Z4S-LE SV-3518V	3Z4S-LE SV-5018V	3Z4S-LE SV-7527V	3Z4S-LE SV-10035V
Appearance/Dimensions (mm)											
Focal length	3.5 mm	4.5 mm	6 mm	8 mm	12 mm	16 mm	25 mm	35 mm	50 mm	75 mm	100 mm
Aperture (F No.)	1.4 to Close	1.4 to Close	1.4 to Close	1.3 to Close	1.4 to Close	1.4 to Close	1.4 to Close	1.8 to Close	1.8 to Close	2.7 to Close	3.5 to Close
Filter size	—	—	M27.0 P0.5	M25.5 P0.5	M27.0 P0.5	M27.0 P0.5	M27.0 P0.5	M27.0 P0.5	M30.5 P0.5	M30.5 P0.5	M30.5 P0.5
Maximum sensor size	1/3 inch	1/3 inch	1/3 inch	1/3 inch	1/3 inch	1/3 inch	1/3 inch	1/3 inch	1/3 inch	1/3 inch	1/3 inch
Mount	C mount										







C-mount Lens for 2/3-inch image sensor (Recommend: FZ-S□2M/FZ-S□5M2/FH-S□05R) (3Z4S-LE SV-7525H and 3Z4S-LE SV-10028H can also be used for FH-S□02 and FH-S□04)

Model	3Z4S-LE SV-0614H	3Z4S-LE SV-0814H	3Z4S-LE SV-1214H	3Z4S-LE SV-1614H	3Z4S-LE SV-2514H	3Z4S-LE SV-3514H	3Z4S-LE SV-5014H	3Z4S-LE SV-7525H	3Z4S-LE SV-10028H
Appearance/Dimensions (mm)									
Focal length	6 mm	8 mm	12 mm	16 mm	25 mm	35 mm	50 mm	75 mm	100 mm
Aperture (F No.)	1.4 to 16	1.4 to 16	1.4 to 16	1.4 to 16	1.4 to 16	1.4 to 16	1.4 to 16	2.5 to Close	2.8 to Close
Filter size	M40.5 P0.5	M35.5 P0.5	M27.0 P0.5	M27.0 P0.5	M27.0 P0.5	M35.5 P0.5	M40.5 P0.5	M34.0 P0.5	M37.5 P0.5
Maximum sensor size	2/3 inch	2/3 inch	2/3 inch	2/3 inch	2/3 inch	2/3 inch	2/3 inch	1 inch	1 inch
Mount	C mount								

C-mount Lens for 1-inch image sensor (Recommend: FH-S□02/FH-S□04) (3Z4S-LE SV-7525H with focal length of 75 mm and 3Z4S-LE SV-10028H with focal length of 100 mm are also available.)

Model	3Z4S-LE VS-0618H1	3Z4S-LE VS-0814H1	3Z4S-LE VS-1214H1	3Z4S-LE VS-1614H1N	3Z4S-LE VS-2514H1	3Z4S-LE VS-3514H1	3Z4S-LE VS-5018H1
Appearance/Dimensions (mm)							
Focal length	6 mm	8 mm	12 mm	16 mm	25 mm	35 mm	50 mm
Aperture (F No.)	1.8 to 16	1.4 to 16	1.4 to 16	1.4 to 16	1.4 to 16	1.4 to 16	1.8 to 16
Filter size	Can not be used a filter	M55.0 P0.75	M35.5 P0.5	M30.5 P0.5	M30.5 P0.5	M30.5 P0.5	M40.5 P0.5
Maximum sensor size	1 inch	1 inch	1 inch	1 inch	1 inch	1 inch	1 inch
Mount	C mount						

M42-mount Lens for large image sensor (Recommend: FH-S□12)



Model	3Z4S-LE VS-L1828/M42-10	3Z4S-LE VS-L2526/M42-10	3Z4S-LE VS-L3528/M42-10	3Z4S-LE VS-L5028/M42-10	3Z4S-LE VS-L8540/M42-10	3Z4S-LE VS-L10028/M42-10
Appearance/Dimensions (mm)						
Focal length	18 mm	25 mm	35 mm	50 mm	85 mm	100 mm
Aperture (F No.)	2.8 to 16	2.6 to 16	2.8 to 16	2.8 to 16	4.0 to 16	2.8 to 16
Filter size	M55.0 P0.75	M55.0 P0.75	M62.0 P0.75	M62.0 P0.75	M52.0 P0.75	M52.0 P0.75
Maximum sensor size	1.8 inch					
Mount	M42 mount					



Lenses for small camera



Model	FZ-LES3	FZ-LES6	FZ-LES16	FZ-LES30
Appearance/Dimensions (mm)				
Focal length	3 mm	6 mm	16 mm	30 mm
Aperture (F No.)	2.0 to 16	2.0 to 16	3.4 to 16	3.4 to 16

Vibrations and Shocks Resistant C-mount Lens for 2/3-inch image sensor (Recommend: FZ-S□/FZ-S□2M/FZ-S□5M2/FZ-SH□/FH-S□/FH-S□05R)

(Vibrations and Shocks Resistant Lenses for 1-inch image sensors and for large image sensors are also available. Ask your OMRON representative for details.)

Model	3Z4S-LE VS-MC15-□□□□□ *1									3Z4S-LE VS-MC20-□□□□□ *1								
Appearance/ Dimensions (mm)																		
Focal length	15 mm									20 mm								
Filter size	M27.0 P0.5									M27.0 P0.5								
Optical magnification	0.03 ×			0.2 ×			0.3 ×			0.04 ×			0.25 ×			0.4 ×		
Aperture (fixed F No.) *2	2	5.6	8	2	5.6	8	2	5.6	8	2	5.6	8	2	5.6	8	2	5.6	8
Depth of field (mm) *3	183.1	512.7	732.4	4.8	13.4	19.2	2.3	6.5	9.2	110.8	291.2	416.0	3.4	9.0	12.8	1.5	3.9	5.6
Maximum sensor size	2/3 inch																	
Mount	C Mount																	

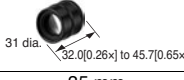
Model	3Z4S-LE VS-MC25N-□□□□□ *1									3Z4S-LE VS-MC30-□□□□□ *1								
Appearance/ Dimensions (mm)																		
Focal length	25 mm									30 mm								
Filter size	M27.0 P0.5									M27.0 P0.5								
Optical magnification	0.05 ×			0.25 ×			0.5 ×			0.06 ×			0.15 ×			0.45 ×		
Aperture (fixed F No.) *2	2	5.6	8	2	5.6	8	2	5.6	8	2	5.6	8	2	5.6	8	2	5.6	8
Depth of field (mm) *3	67.2	188.2	268.8	3.2	9.0	12.8	1.0	2.7	3.8	47.1	131.9	188.4	8.2	22.9	32.7	1.1	3.2	4.6
Maximum sensor size	2/3 inch																	
Mount	C Mount																	

Model	3Z4S-LE VS-MC35-□□□□□ *1									3Z4S-LE VS-MC50-□□□□□ *1								
Appearance/ Dimensions (mm)																		
Focal length	35 mm									50 mm								
Filter size	M27.0 P0.5									M27.0 P0.5								
Optical magnification	0.26 ×			0.3 ×			0.65 ×			0.08 ×			0.2 ×			0.48 ×		
Aperture (fixed F No.) *2	1.9	5.6	8	1.9	5.6	8	1.9	5.6	8	2	5.6	8	2	5.6	8	2	5.6	8
Depth of field (mm) *3	2.8	8.4	11.9	2.2	6.5	9.2	0.6	1.7	2.5	33.8	75.6	108.0	6.0	13.4	19.2	1.3	2.9	4.1
Maximum sensor size	2/3 inch																	
Mount	C Mount																	

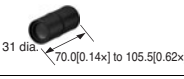
Model	3Z4S-LE VS-MC75-□□□□□ *1								
Appearance/ Dimensions (mm)									
Focal length	75 mm								
Filter size	M27.0 P0.5								
Optical magnification	0.14 ×			0.2 ×			0.62 ×		
Aperture (fixed F No.) *2	3.8	5.6	8	3.8	5.6	8	3.8	5.6	8
Depth of field (mm) *3	17.7	26.1	37.2	9.1	13.4	19.2	1.3	1.9	2.7
Maximum sensor size	2/3 inch								
Mount	C Mount								

*1 Insert the aperture into □□□□□ in the model number as follows.

F=1.9 to 3.8: blank

F=5.6: FN056

F=8: FN080

*2 F-number can be selected from maximum aperture, 5.6, and 8.0.

*3 When circle of least confusion is 40 μm.



**High-resolution Telecentric Lens for C-mount Lens for 2/3-inch image sensor
(Recommend: FZ-S□/FZ-SH□/FZ-S□2M/FZ-S□5M2/FH-S□/FH-S□05R)**

Model *1	3Z4S-LE VS-TCH05 -65□□□□	3Z4S-LE VS-TCH05 -110□□□□	3Z4S-LE VS-TCH1 -65□□□□	3Z4S-LE VS-TCH1 -110□□□□	3Z4S-LE VS-TCH1.5 -65□□□□	3Z4S-LE VS-TCH1.5 -110□□□□	3Z4S-LE VS-TCH2 -65□□□□	3Z4S-LE VS-TCH2 -110□□□□	3Z4S-LE VS-TCH4 -65□□□□	3Z4S-LE VS-TCH4 -110□□□□
Optical magnification (±5%)	0.5x		1.0x		1.5x		2.0x		4.0x	
Field of view (±5%) (VxH) (mm)	FH-SC/-SM	1/3 inch equivalent	9.6×7.2		4.8×3.6		3.2×2.4		2.4×1.8	
	FH-S□05R	1/2.5 inch equivalent	11.4×8.56		5.7×4.28		3.8×2.85		2.85×2.14	
	FZ-SC/-S	1/3 inch equivalent	9.6×7.2		4.8×3.6		3.2×2.4		2.4×1.8	
	FZ-SC2M /-S2M	1/1.8 inch equivalent	14.0×10.6		7.0×5.3		4.7×3.5		3.5×2.7	
	FZ-SC5M□ /-S5M□	2/3 inch equivalent	16.8×14.2		8.4×7.1		5.6×4.7		4.2×3.6	
WD(mm) *2	75.3	110.8	68.8	110.3	65	110.8	65	110.8	65	110.8
Effective FNO	9.42	9.49	9.94	10.49	11.8	11.97	13.6	13.5	17.91	22.2
Depth of field (mm) *3	3	3.04	0.8	0.84	0.4	0.43	0.3	0.27	0.09	0.11
Resolution *4	12.43	12.9	6.71	6.99	5.24	5.33	4.53	4.53	3	3.73
TV distortion	0.02%	0.02%	0.01%	0.02%	0.01%	0.02%	0.03%	0.03%	0.02%	0.03%
Maximum sensor size	2/3 inch		2/3 inch		2/3 inch		2/3 inch		2/3 inch	

*1 Insert the shape into □□□□ in the model number as follows.

Straight : -O
Coaxial : CO-O

*2 The working distance is the distance from the end of the lens to the sensor.

*3 The depth of field is calculated using a permissible circle of confusion diameter of 0.04 mm.

*4 The resolution is calculated using a wavelength of 550 nm.

Note: 1. Fixing the lens or other reinforcement may be required depending on the installation angle or operating environment (vibration/shock).
When fixing the lens, insulate the lens from the fixture.

2. The above specifications are values calculated from the optical design and can vary depending on installation conditions.

Extension Tubes

Lenses	For M42 mount Lenses *	For C mount Lenses *	For Small Digital CCD Cameras
Model	3Z4S-LE VS-EXR/M42	3Z4S-LE SV-EXR	FZ-LESR
Contents	Set of 5 tubes (20 mm, 10 mm, 8 mm, 2 mm, and 1 mm) Maximum outer diameter: 47.5 mm dia.	Set of 7 tubes (40 mm, 20 mm, 10 mm, 5 mm, 2.0 mm, 1.0 mm, and 0.5 mm) Maximum outer diameter: 30 mm dia.	Set of 3 tubes (15 mm, 10 mm, 5 mm) Maximum outer diameter: 12 mm dia.

* Do not use the 0.5-mm, 1.0-mm, and 2.0-mm Extension Tubes attached to each other. Since these Extension Tubes are placed over the threaded section of the Lens or other Extension Tube, the connection may loosen when more than one 0.5-mm, 1.0-mm or 2.0-mm Extension Tube are used together. Reinforcement is required to protect against vibration when Extension Tubes exceeding 30 mm are used. When using the Extension Tube, check it on the actual device before using it.

FH-Series

Ratings and Specifications (FH Sensor Controllers)

High-speed Controllers/Standard Controllers

Sensor Controller Series		FH-3000 series			FH-1000 series			
Type		High-speed Controller (4 cores)			Standard Controller (2 cores)			
Sensor Controller Model		FH-3050	FH-3050-10	FH-3050-20	FH-1050	FH-1050-10	FH-1050-20	
Controller Type		BOX type						
Parallel IO		NPN/PNP (common)						
Main Functions	Operation Mode	Standard	Yes					
		Double Speed Multi-input	Yes					
		Non-stop adjustment mode	Yes					
		Multi-line random-trigger mode	Yes (Maximum 8 lines)					
	Parallel Processing		Yes					
	Number of Connectable Camera		2	4	8	2	4	8
	Supported Camera	FH-S series camera	All of the FH-S series cameras are connectable.		All of the FH-S series cameras are connectable. *1	All of the FH-S series cameras are connectable.		All of the FH-S series cameras are connectable. *1
		FZ-S series camera	All of the FZ-S series cameras are connectable.					
	Camera I/F		OMRON I/F					
	Possible Number of Captured Images		Refer to page 36.					
Possible Number of Logging Images to Sensor Controller		128						
Possible Number of Scenes		128						
Operating on UI	USB Mouse	Yes (wired USB and driver is unnecessary type)						
	Touch Panel	Yes (RS-232C/USB connection: FH-MT12)						
Setup		Create the processing flow using Flow editing.						
Language		Japanese, English, Simplified Chinese, Traditional Chinese, Korean, German, French, Spanish, Italian						
Serial Communication		RS-232C × 1						
Ethernet Communication	Protocol	Non-procedure (TCP/UDP)						
	I/F	1000BASE-T × 1	1000BASE-T × 2		1000BASE-T × 1	1000BASE-T × 2		
EtherNet/IP Communication		Ethernet port (transmission rate: 1Gbps)						
EtherCAT Communication		Yes (slave)						
External Interface	Parallel I/O	<ul style="list-style-type: none"> • 12 inputs/31 outputs: <ul style="list-style-type: none"> • Use 1 Line. • Operation mode: Except Multi-line random-trigger mode. • 17 inputs/37 outputs: <ul style="list-style-type: none"> • Use 2 Lines. • Operation mode: Multi-line random-trigger mode. • 14 inputs/29 outputs: <ul style="list-style-type: none"> • Use 3 to 4 Lines. • Operation mode: Multi-line random-trigger mode. • 19 inputs/34 outputs: <ul style="list-style-type: none"> • Use 5 to 8 Lines. • Operation mode: Multi-line random-trigger mode. 						
		Encoder Interface						
		Monitor Interface						
		USB I/F						
	SD Card I/F							
Indicator Lamps	Main	POWER: Green ERROR: Red RUN: Green ACCESS: Yellow						
	Ethernet	NET RUN: Green NET LINK ACT: Yellow	NET RUN1: Green NET LINK ACK1: Yellow NET RUN2: Green NET LINK ACK2: Yellow		NET RUN: Green NET LINK ACT: Yellow	NET RUN1: Green NET LINK ACK1: Yellow NET RUN2: Green NET LINK ACK2: Yellow		
	SD Card	SD POWER: Green SD BUSY: Yellow						
	EtherCAT	EtherCAT RUN LED: Green EtherCAT LINK/ACT IN LED: Green EtherCAT LINK/ACT OUT LED: Green EtherCAT ERR LED: Red						
Power-supply voltage		20.4 VDC to 26.4 VDC						
Current consumption	When connected to a Controller	Connected to 2 cameras	5.0 A max.	5.4 A max.	6.4 A max.	4.7 A max.	5.0 A max.	5.9 A max.
		Connected to 4 cameras	---	7.0 A max.	8.1 A max.	---	6.5 A max.	7.5 A max.
	When not connected to Controller	Connected to 2 cameras	4.1 A max.	4.2 A max.	5.2 A max.	3.6 A max.	3.7 A max.	4.5 A max.
		Connected to 4 cameras	---	4.8 A max.	5.6 A max.	---	4.3 A max.	5.0 A max.
Built-in FAN		Yes						
Usage Environment	Ambient temperature range		Operating: 0°C to 50°C Storage: -20 to +85°C (with no icing or condensation)					
	Ambient humidity range		Operating: 35 to 85%RH Storage: 35 to 85%RH (with no condensation)					
	Ambient atmosphere		No corrosive gases					
	Vibration tolerance		Oscillation frequency: 10 to 150 Hz Half amplitude: 0.1 mm Acceleration: 15 m/s ² Sweep time: 8 minute/count Sweep count: 10 Vibration direction: up and down/front and behind/left and right					
	Shock resistance		Impact force: 150 m/s ² Test direction: up and down/front and behind/left and right					
	Noise immunity	Fast Transient Burst	<ul style="list-style-type: none"> • DC power <ul style="list-style-type: none"> Direct infusion: 2kV, Pulse rising: 5ns, Pulse width: 50ns, Burst continuation time: 15ms/0.75ms, Period: 300ms, Application time: 1 min • I/O line <ul style="list-style-type: none"> Direct infusion: 1kV, Pulse rising: 5ns, Pulse width: 50ns, Burst continuation time: 15ms/0.75ms, Period: 300ms, Application time: 1 min 					
			Grounding					
External Features	Dimensions		190 mm × 115 mm × 182.5 mm Note Height: Including the rubber feet at the base.					
	Weight		Approx. 3.2 kg	Approx. 3.4 kg	Approx. 3.4 kg	Approx. 3.2 kg	Approx. 3.4 kg	Approx. 3.4 kg
	Degree of protection		IEC60529 IP20					
	Case material		Cover: zinc-plated steel plate Side plate: aluminum (A6063)					
Accessories		Instruction Sheet (Japanese and English): 1. Instruction Installation Manual for FH series:1. General Compliance Information and Instructions for EU:1, Power source(FH-XCN): 1 (male), Ferrite core for camera cable: 2(FH-3050, FH-1050), 4(FH-3050-10, FH-1050-10), 8(FH-3050-20, FH-1050-20)						

*1 When the 12 megapixels camera: Max. 4 cameras are connectable. When use except 12 megapixels cameras: Max. 8 cameras are connectable.

*2 Existing third class grounding

Lite Controllers

Sensor Controller Series			FH-L series		
Type			Lite Controller		
Sensor Controller Model			FH-L550		FH-L550-10
Controller Type			BOX type		
Parallel IO			NPN/PNP (common)		
Main Functions	Operation Mode	Standard	Yes		
		Double Speed Multi-input	Yes		
		Non-stop adjustment mode	Yes		
		Multi-line random-trigger mode	No		
	Parallel Processing		Yes		
	Number of Connectable Camera		2	4	
	Supported Camera	FH-S series camera	All of the FH-S series cameras are connectable		
		FZ-S series camera	All of the FZ-S series cameras are connectable.		
	Camera I/F		OMRON I/F		
	Possible Number of Captured Images		Refer to page 36.		
	Possible Number of Logging Images to Sensor Controller		Refer to page 36.		
	Possible Number of Scenes		128		
	UI Operations	USB Mouse	Yes (wired USB driver-less type)		
		Touch Panel	Yes (RS-232C/USB connection: FH-MT12)		
Setup		Create the processing flow using Flow editing.			
Language		Japanese, English, Simplified Chinese, Traditional Chinese, Korean, German, French, Spanish, Italian			
External Interface	Serial Communication		RS-232C × 1		
	Ethernet Communication	Protocol	Non-procedure (TCP/UDP)		
		I/F	1000BASE-T × 1		
	EtherNet/IP Communication		Ethernet port (transmission rate: 1 Gbps)		
	EtherCAT Communication		No		
	Parallel I/O		<ul style="list-style-type: none"> • High-speed input: 1 • Normal speed: 9 • High-speed output: 4 • Normal speed: 23 		
	Encoder Interface		None		
	Monitor Interface		DVI-I output (Analog RGB & DVI-D single link) × 1		
	USB I/F		USB2.0 host × 1; BUS Power: Port 5 V/0.5 A USB3.0 × 1; BUS Power: Port 5 V/0.5 A		
	SD Card I/F		SDHC × 1		
Indicator Lamps	Main		POWER: Green ERROR: Red RUN: Green ACCESS: Yellow		
	Ethernet		NET RUN: Green NET LINK ACT: Yellow		
	SD Card		SD POWER: Green SD BUSY: Yellow		
	EtherCAT		None		
Power-supply voltage			20.4 VDC to 26.4 VDC		
Current consumption	When connected to a Controller	Connected to 2 cameras	3.5 A max.		3.7 A max.
		Connected to 4 cameras	---		5.9 A max.
		Connected to 8 cameras	---		---
	When not connected to Controller	Connected to 2 cameras	1.5 A max.		1.7 A max.
		Connected to 4 cameras	---		2.0 A max.
		Connected to 8 cameras	---		---
Built-in FAN			No		
Usage Environment	Ambient temperature range		Operating: 0°C to 55°C Storage: -25 to +70°C		
	Ambient humidity range		Operating and Storage: 10 to 90%RH (with no condensation)		
	Ambient atmosphere		No corrosive gases		
	Vibration tolerance		5 to 8.4 Hz with 3.5 mm amplitude, 8.4 to 150 Hz, acceleration of 9.8 m/s ² 100 min each in X, Y, and Z directions (10 sweeps of 10 min each = 100 min total)		
	Shock resistance		Impact force: 150 m/s ² Test direction: up and down/front and behind/left and right		
	Noise immunity	Fast Transient Burst	<ul style="list-style-type: none"> • DC power Direct infusion: 2kV, Pulse rising: 5ns, Pulse width: 50ns, Burst continuation time: 15ms/0.75ms, Period: 300ms, Application time: 1 min • I/O line Direct infusion: 1kV, Pulse rising: 5ns, Pulse width: 50ns, Burst continuation time: 15ms/0.75ms, Period: 300ms, Application time: 1 min 		
			Grounding		
External Features	Dimensions		200 mm × 80 mm × 130 mm		
	Weight		Approx. 1.5 kg		Approx. 1.5 kg
	Degree of protection		IEC60529 IP20		
	Case materials		PC		
Accessories			Instruction Sheet (Japanese and English): 1, Instruction Installation Manual for FH-L series:1, General Compliance Information and Instructions for EU:1, Power source(FH-XCN-L):1 (male)		

* Existing third class grounding

Number of logged images/Max. Number of Loading Images during Multi-input

Cameras	Color/ Monochrome	Model	Number of logged images *1								Max. Number of Loading Images during Multi-input *2
			Connected to 1 camera	Connected to 2 camera	Connected to 3 camera	Connected to 4 camera	Connected to 5 camera	Connected to 6 camera	Connected to 7 camera	Connected to 8 camera	
Intelligent Compact Digital CMOS Cameras *3	Color	FZ-SQ010F/-SQ050F/ -SQ100F/-SQ100N	232	116	77	58	46	38	33	29	256
300,000 pixels CCD Cameras	Monochrome	FZ-S/-SF/-SH/-SP	272	136	90	68	54	45	38	34	
300,000 pixels CMOS Cameras	Monochrome	FH-SM	272	136	90	68	54	45	38	34	256
	Color	FH-SC	270	135	90	67	54	45	38	33	
2 million pixels CMOS Cameras	Color/ Monochrome	FH-SC02/-SM02	37	18	12	9	7	6	5	4	51
2 million pixels CCD Cameras	Color/ Monochrome	FZ-SC2M/-S2M	43	21	14	10	8	7	6	5	64
4 million pixels CMOS Cameras	Color/ Monochrome	FH-SC04/-SM04	20	10	6	5	4	3	2	2	32
5 million pixels CCD Cameras	Color/ Monochrome	FZ-SC5M2/-S5M2	16	8	5	4	3	2	2	2	25
5 million pixels Digital CMOS Cameras	Color/ Monochrome	FH-SC05R/-SM05R	16	8	5	4	3	2	2	2	25
12 million pixels CMOS Cameras	Color/Mono- chrome	FH-SC12/-SM12	6	3	2	2	---	---	---	---	10

*1 Maximum number of saveable logging images differ depending on scene settings. Refer to Vision System FH/FZ5 Series User's Manual (Z340).

*2 When using two camera cables for connection, the maximum number of loaded images during multi-input is twice the number given in the table.

*3 The multi-input function cannot be used when the built-in lighting of an intelligent compact Digital camera is used.

Refer to the Vision System FH/FZ5 Series User's Manual (Cat. No. Z340) for details.

Ratings and Specifications (Cameras)

High-speed Digital CMOS cameras

Model	FH-SM	FH-SC	FH-SM02	FH-SC02	FH-SM04	FH-SC04	FH-SM12	FH-SC12
Image elements	CMOS image elements (1/3-inch equivalent)		CMOS image elements (2/3-inch equivalent)		CMOS image elements (1-inch equivalent)		CMOS image elements (1.76-inch equivalent)	
Color/Monochrome	Monochrome	Color	Monochrome	Color	Monochrome	Color	Monochrome	Color
Effective pixels	640 (H) × 480 (V)		2040 (H) × 1088 (V)		2040 (H) × 2048 (V)		4084 (H) × 3072 (V)	
Imaging area H × V (opposing corner)	4.8 × 3.6 (6.0 mm)		11.26 × 5.98 (12.76 mm)		11.26 × 11.26 (15.93 mm)		22.5 × 16.9 (28.14 mm)	
Pixel size	7.4 (μm) × 7.4 (μm)		5.5 (μm) × 5.5 (μm)		5.5 (μm) × 5.5 (μm)		5.5 (μm) × 5.5 (μm)	
Shutter function	Electronic shutter; Shutter speeds can be set from 20 μs to 100 ms.		Electronic shutter; Shutter speeds can be set from 25 μs to 100 ms.				Electronic shutter; Shutter speeds can be set from 60 μs to 100 ms.	
Partial function	1 to 480 lines	2 to 480 lines	1 to 1088 lines	2 to 1088 lines	1 to 2048 lines	2 to 2048 lines	4 to 3072 lines (4-line increments)	
Frame rate (Image Acquisition Time)	308 fps (3.3 ms)		219 fps (4.6 ms) *		118 fps (8.5 ms) *		38.9 fps (25.7 ms) *	
Lens mounting	C mount						M42 mount	
Field of vision, installation distance	Selecting a lens according to the field of vision and installation distance							
Ambient temperature range	Operating: 0 to 40 °C, Storage: -25 to 65 °C (with no icing or condensation)							
Ambient humidity range	Operating and storage: 35% to 85% (with no condensation)							
Weight	Approx.105 g			Approx.110 g			Approx.320 g	
Accessories	Instruction manual							

* Frame rate in high speed mode when the camera is connected using two camera cables.

Digital CMOS Cameras

Model	FH-SM05R	FH-SC05R
Image Elements	CMOS image elements (1/2.5-inch equivalent)	
Color/Monochrome	Monochrome	Color
Effective Pixels	2592 (H) × 1944 (V)	
Imaging area H × V (opposing corner)	5.70 × 4.28 (7.13 mm)	
Pixel Size	2.2 (μm) × 2.2 (μm)	
Scan Type	Progressive	
Shutter Method	Rolling shutter	
Shutter Function	Electronic shutter; Shutter speeds can be set from 500 to 10000 ms in multiples of 50 μs	
Frame Rate (Image Acquisition Time)	14 fps (71.7 ms)	
Lens Mounting	C mount	
Field of vision, Installation distance	Selecting a lens according to the field of vision and installation distance	
Ambient temperature range	Operating: 0 to +40°C Storage: -30 to 65°C (with no icing or condensation)	
Ambient humidity range	Operating: 35 to 85%RH Storage: 35 to 85%RH (with no condensation)	
Weight	Approx. 52 g	
Accessories	Instruction Sheet	

Digital CCD Cameras

Model	FZ-S	FZ-SC	FZ-S2M	FZ-SC2M	FZ-S5M2	FZ-SC5M2
Image elements	Interline transfer reading all pixels, CCD image elements (1/3-inch equivalent)		Interline transfer reading all pixels, CCD image elements (1/1.8-inch equivalent)		Interline transfer reading all pixels, CCD image elements (2/3-inch equivalent)	
Color/Monochrome	Monochrome	Color	Monochrome	Color	Monochrome	Color
Effective pixels	640 (H) × 480 (V)		1600 (H) × 1200 (V)		2448 (H) × 2044 (V)	
Imaging area H x V (opposing corner)	4.8 × 3.6 (6.0mm)		7.1 × 5.4 (8.9mm)		8.4 × 7.1 (11mm)	
Pixel size	7.4 (μm) × 7.4 (μm)		4.4 (μm) × 4.4 (μm)		3.45 (μm) × 3.45 (μm)	
Shutter function	Electronic shutter; select shutter speeds from 20 μs to 100 ms					
Partial function	12 to 480 lines		12 to 1200 lines		12 to 2044 lines	
Frame rate (Image Acquisition Time)	80 fps (12.5 ms)		30 fps (33.3 ms)		16 fps (62.5 ms)	
Lens mounting	C mount					
Field of vision, installation distance	Selecting a lens according to the field of vision and installation distance					
Ambient temperature range	Operating: 0 to 50 °C Storage: -25 to 65 °C (with no icing or condensation)		Operating: 0 to 40 °C Storage: -25 to 65 °C (with no icing or condensation)			
Ambient humidity range	Operating and storage: 35% to 85% (with no condensation)					
Weight	Approx. 55 g		Approx. 76 g		Approx. 140 g	
Accessories	Instruction manual					

Small CCD Digital Cameras

Model	FZ-SF	FZ-SFC	FZ-SP	FZ-SPC
Image elements	Interline transfer reading all pixels, CCD image elements (1/3-inch equivalent)			
Color/Monochrome	Monochrome	Color	Monochrome	Color
Effective pixels	640 (H) × 480 (V)			
Imaging area H x V (opposing corner)	4.8 × 3.6 (6.0mm)			
Pixel size	7.4 (μm) × 7.4 (μm)			
Shutter function	Electronic shutter; select shutter speeds from 20 μs to 100 ms			
Partial function	12 to 480 lines			
Frame rate (Image Acquisition Time)	80 fps (12.5ms)			
Lens mounting	Special mount (M10.5 P0.5)			
Field of vision, installation distance	Selecting a lens according to the field of vision and installation distance			
Ambient temperature range	Operating: 0 to 50 °C (camera amp) 0 to 45 °C (camera head) Storage: -25 to 65 °C (with no icing or condensation)			
Ambient humidity range	Operating and storage: 35% to 85% (with no condensation)			
Weight	Approx. 150 g			
Accessories	Instruction manual, installation bracket, Four mounting brackets (M2)		Instruction manual	

High-speed Digital CCD Cameras

Model	FZ-SH	FZ-SHC
Image elements	Interline transfer reading all pixels, CCD image elements (1/3-inch equivalent)	
Color/Monochrome	Monochrome	Color
Effective pixels	640 (H) × 480 (V)	
Imaging area H x V (opposing corner)	4.8 × 3.6 (6.0mm)	
Pixel size	7.4 (μm) × 7.4 (μm)	
Shutter function	Electronic shutter; select shutter speeds from 1/10 to 1/50,000 s	
Partial function	12 to 480 lines	
Frame rate (Image Acquisition Time)	204 fps (4.9ms)	
Field of vision, installation distance	Selecting a lens according to the field of vision and installation distance	
Ambient temperature range	Operating: 0 to 40 °C Storage: -25 to 65 °C (with no icing or condensation)	
Ambient humidity range	Operating and storage: 35% to 85% (with no condensation)	
Weight	Approx. 105 g	
Accessories	Instruction manual	

Intelligent Compact Digital CMOS Cameras

Model	FZ-SQ010F	FZ-SQ050F	FZ-SQ100F	FZ-SQ100N
Image elements	CMOS color image elements (1/3-inch equivalent)			
Color/Monochrome	Color			
Effective pixels	752 (H) × 480 (V)			
Imaging area H x V (opposing corner)	4.51 × 2.88 (5.35mm)			
Pixel size	6.0 (μm) × 6.0 (μm)			
Shutter function	1/250 to 1/32,258			
Partial function	8 to 480 lines			
Frame rate (Image Acquisition Time)	60 fps (16.7 ms)			
Field of vision	7.5 × 4.7 to 13 × 8.2 mm	13 × 8.2 to 53 × 33 mm	53 × 33 to 240 × 153 mm	29 × 18 to 300 × 191 mm
Installation distance	38 to 60 mm	56 to 215 mm	220 to 970 mm	32 to 380 mm
LED class *	Risk Group2			
Ambient temperature range	Operating: 0 to 50 °C Storage: -25 to 65 °C			
Ambient humidity range	Operating and storage: 35% to 85% (with no condensation)			
Weight	Approx. 150 g		Approx. 140 g	
Accessories	Mounting bracket (FQ-XL), polarizing filter attachment (FQ-XF1), instruction manual and warning label			

* Applicable standards: IEC62471-2

• Narrow View FZ-SQ010F

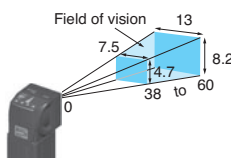

• Standard FZ-SQ050F

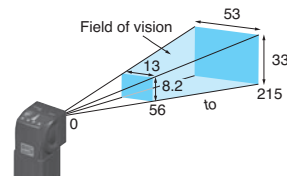

• Wide View (Long-distance) FZ-SQ100F

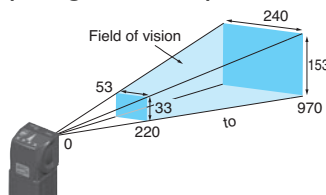

• Wide View (Short-distance) FZ-SQ100N

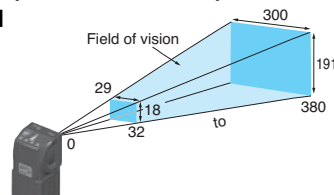

Ratings and Specifications (Cable, Monitor)

Camera Cables

Model	FZ-VS3 (2 m)	FZ-VSB3 (2 m)	FZ-VSL3 (2 m)	FZ-VSLB3 (2 m)
Type	Standard	Bend resistant	Right-angle	Bend resistant Right-angle
Shock resistiveness (durability)	10 to 150 Hz single amplitude 0.15 mm 3 directions, 8 strokes, 4 times			
Ambient temperature range	Operation and storage: 0 to 65 °C (with no icing or condensation)			
Ambient humidity range	Operation and storage: 40 to 70%RH (with no condensation)			
Ambient atmosphere	No corrosive gases			
Material	Cable sheath, connector: PVC			
Minimum bending radius	69mm	69mm	69mm	69mm
Weight	Approx. 170 g	Approx. 180 g	Approx. 170 g	Approx. 180 g

Cable Extension Unit

Model	FZ-VSJ
Power supply voltage *1	11.5 to 13.5 VDC
Current consumption *2	1.5 A max.
Ambient temperature range	Operating: 0 to 50 °C; Storage: -25 to 65 °C (with no icing or condensation)
Ambient humidity range	Operating and storage: 35 to 85% (with no condensation)
Weight	Approx. 240 g
Accessories	Instruction Sheet and 4 mounting screws

*1 A 12-VDC power supply must be provided to the Cable Extension Unit when connecting the Intelligent Compact Camera, or the Lighting Controller.

*2 The current consumption shows when connecting the Cable Extension Unit to an external power supply.

Touch Panel Monitor

Model	FH-MT12	
Major Function	Display area	12.1 inch
	Resolution	1024 (V) × 768 (H)
	Number of color	16,700,000 colors (8 bit/color)
	Brightness	500cd/m ² (Typ)
	Contrast Ratio	600:1 (Typ)
	Viewing angle	Left and right: each 80°, upward: 80°, downward: 60°
	Backlight Unit	LED, edge-light
	Backlight lifetime	About 100,000hour
External interface	Touch panel	4wire resistive touch screen
	Video input	analog RGB
	Touch panel signal	USB RS-232C
Ratings	Power supply voltage	24 VDC (21.6 to 26.4 VDC)
	Current consumption	0.5A
	Insulation resistance	Between DC power supply and Touch Panel Monitor FG: 20 MΩ or higher (rated voltage 250 V)
Operating environment	Ambient temperature range	Operating: 0 to 50°C, Storage: -20 to +65°C (with no icing or condensation)
	Ambient humidity range	Operating and Storage: 20 to 85 %RH (with no icing or condensation)
	Ambient environment	No corrosive gas
	Vibration resistance	10 to 150 Hz, one-side amplitude 0.1 mm (Max. acceleration 15 m/s ²) 10 times for 8 minutes for each three direction
	Degree of protection	Panel mounting: IP65 on the front
Operation	Touch pen	
Structure	Mounting	Panel mounting, VESA mounting
	Weight	Approx.2.6 kg
	Material	Front panel: PC/PBT, Front Sheet: PET, Rear case: SUS

Note: FH Series Sensor Controllers version 5.32 or higher is required.

Touch Panel Monitor Cables

Model	FH-VMDA (2 m)	FH-VUAB (2 m)	XW2Z-200PP-1 (2 m)
Cable type	DVI-Analog Conversion Cable	USB Cable	RS-232C Cable
Vibration resistance	10 to 150 Hz, one-side amplitude 0.1 mm, 10 times for 8 minutes for each three direction		
Ambient Temperature	Operating Condition: 0 to 50°C, Storage Condition: -10 to 60°C (with no icing or condensation)		
Ambient Humidity	Operating Condition: 35 to 85%RH, Storage Condition: 35 to 85%RH (with no icing or condensation)		
Ambient environment	No corrosive gases		
Material	Cable outer sheath, Connector: PVC		Cable outer sheath: PVC, Connector: ABS/Ni Plating
Minimum bend radius	36 mm	25 mm	59 mm
Weight	Approx.220 g	Approx.75 g	Approx.162 g

Long-distance Camera Cables

Model	FZ-VS4 (15 m)	FZ-VSL4 (15 m)
Type	Standard	Right-angle
Shock resistiveness (durability)	10 to 150 Hz single amplitude 0.15 mm 3 directions, 8 strokes, 4 times	
Ambient temperature range	Operation and storage: 0 to 65 °C (with no icing or condensation)	
Ambient humidity range	Operation and storage: 40 to 70%RH (with no condensation)	
Ambient atmosphere	No corrosive gases	
Material	Cable sheath, connector: PVC	
Minimum bending radius	78 mm	
Weight	Approx. 1400 g	

Encoder Cable

Model	FH-VR
Vibration resistiveness	10 to 150 Hz single amplitude 0.1 mm 3 directions, 8 strokes, 10 times
Ambient temperature range	Operation: 0 to 50 °C; Storage: -10 to 60 °C (with no icing or condensation)
Ambient humidity range	Operation and storage: 35 to 85%RH (with no condensation)
Ambient atmosphere	No corrosive gases
Material	Cable Jacket: Heat, oil and flame resistant PVC Connector: polycarbonate resin
Minimum bending radius	65 mm
Weight	Approx. 104 g

LCD Monitor

Model	FZ-M08
Size	8.4 inches
Type	Liquid crystal color TFT
Resolution	1,024 × 768 dots
Input signal	Analog RGB video input, 1 channel
Power supply voltage	21.6 to 26.4 VDC
Current consumption	Approx. 0.7 A max.
Ambient temperature range	Operating: 0 to 50 °C; Storage: -25 to 65 °C (with no icing or condensation)
Ambient humidity range	Operating and storage: 35 to 85% (with no condensation)
Weight	Approx. 1.2 kg
Accessories	Instruction Sheet and 4 mounting brackets

LCD Monitor Cable

Model	FZ-VM
Vibration resistiveness	10 to 150 Hz single amplitude 0.15 mm 3 directions, 8 strokes, 4 times
Ambient temperature range	Operation: 0 to 50 °C; Storage: -20 to 65 °C (with no icing or condensation)
Ambient humidity range	Operation and storage: 35 to 85%RH (with no condensation)
Ambient atmosphere	No corrosive gases
Material	Cable sheath: heat-resistant PVC Connector: PVC
Minimum bending radius	75 mm
Weight	Approx. 170 g

Note: When you connect a LCD Monitor FZ-M08 to FH sensor controller, please use it in combination with a DVI-I -RGB Conversion Connector FH-VMRGB.

EtherCAT Communications Specifications

Item	Specifications	
Communications standard	IEC61158 Type 12	
Physical layer	100 BASE-TX (IEEE802.3)	
Modulation	Base band	
Baud rate	100 Mbps	
Topology	Depends on the specifications of the EtherCAT master.	
Transmission Media	Twisted-pair cable of category 5 or higher (double-shielded straight cable with aluminum tape and braiding)	
Transmission Distance	Distance between nodes: 100 m or less	
Node address setting	00 to 9	
External connection terminals	RJ45 × 2 (shielded) IN: EtherCAT input data, OUT: EtherCAT output data	
Send/receive PDO data sizes	Input	56 to 280 bytes/line (including input data, status, and unused areas) Up to 8 lines can be set. *
	Output	28 bytes/line (including output data and unused areas) Up to 8 lines can be set. *
Mailbox data size	Input	512 bytes
	Output	512 bytes
Mailbox	Emergency messages, SDO requests, and SDO information	
Refreshing methods	I/O-synchronized refreshing (DC)	

* This depends on the upper limit of the master.

Version Information

FH Series and Programming Devices

Use the latest version of Sysmac Studio Standard Edition/Vision Edition.

FH Series	Version of FH Series	Corresponding version of Sysmac Studio Standard Edition/Vision Edition
FH-3050 (-□) FH-1050 (-□)	Version 5.60	Supported by version 1.15 or higher.
	Version 5.50	Supported by version 1.14.89 or higher.
	Version 5.30	Supported by version 1.10.80 or higher.
	Version 5.20	Supported by version 1.10 or higher.
	Version 5.10	Supported by version 1.07.43 or higher.
	Version 5.00	Supported by version 1.07 or higher. Not supported by version 1.06 or lower.

Components and Functions

**Sensor Controllers
High-speed Controllers/
Standard Controllers
BOX type
(4-camera type)**

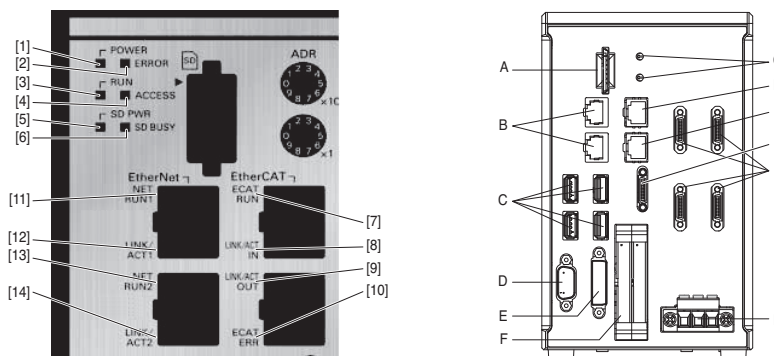

	Name	Description
[1]	POWER LED	Lit while power is ON.
[2]	ERROR LED	Lit when an error has occurred.
[3]	RUN LED	Lit while the layout turned on output setting is displayed.
[4]	ACCESS LED	Blinks while the internal nonvolatile memory is accessed.
[5]	SD POWER LED	Blinks while power is supplied to the SD memory card and the card is usable.
[6]	SD BUSY LED	Blinks while the SD memory card is accessed.
[7]	EtherCAT RUN LED	Lit while EtherCAT communications are usable.
[8]	EtherCAT LINK/ACT IN LED	Lit when connected with an EtherCAT device, and blinks while performing communications.
[9]	EtherCAT LINK/ACT OUT LED	Lit when connected with an EtherCAT device, and blinks while performing communications.
[10]	EtherCAT ERR LED	Lit when EtherCAT communications have become abnormal.
[11]	EtherNet NET RUN1 LED	Lit while EtherNet communications are usable.
[12]	EtherNet NET LINK/ACK1 LED	Lit when connected with an EtherNet device, and blinks while performing communications.
[13]	EtherNet NET RUN2 LED	Lit when EtherNet communications are usable.
[14]	EtherNet NET LINK/ACK2 LED	Lit when connected with an EtherNet device, and blinks while performing communications.

	Name	Description						
A	SD memory card installation connector	Install the SD memory card. Do not plug or unplug the SD memory card during measurement operation. Otherwise measurement time may be affected or data may be destroyed.						
B	EtherNet connector	<p>Connect an EtherNet device.</p> <table border="1"> <thead> <tr> <th>Camera 2ch type</th> <th>Camera 4ch/8ch type</th> </tr> </thead> <tbody> <tr> <td> </td> <td> </td> </tr> <tr> <td> </td> <td> </td> </tr> </tbody> </table> <p>Upper port : Ethernet port Lower port : Ethernet port and EtherNet/IP port are sharing use.</p>	Camera 2ch type	Camera 4ch/8ch type				
Camera 2ch type	Camera 4ch/8ch type							
C	USB connector	Connect a USB device. Do not plug or unplug it during measurement operation. Otherwise measurement time may be affected or data may be destroyed.						
D	RS-232C connector	Connect an external device such as a programmable controller.						
E	DVI-I connector	Connect a monitor.						
F	I/O connector (control lines, data lines)	Connect the controller to external devices such as a sync sensor and PLC.						
G	EtherCAT address setup volume	Used to set a node address (00 to 99) as an EtherCAT communication device.						
H	EtherCAT communication connector (IN)	Connect the opposed EtherCAT device.						
I	EtherCAT communication connector (OUT)	Connect the opposed EtherCAT device.						
J	Encoder connector	Connect an encoder.						
K	Camera connector	Connect cameras.						
L	Power supply terminal connector	Connect a DC power supply. Wire the controller independently on other devices. Wire * the ground line. Be sure to ground the controller alone.						

* Use the attachment power terminal connector (male) of FH-XCN series.
For details, refer to 5-3 Sensor Controller Installation on Vision System FH/FZ5 series Hardware Setup Manual (Z366).

Lite Controllers BOX type (4-camera type)

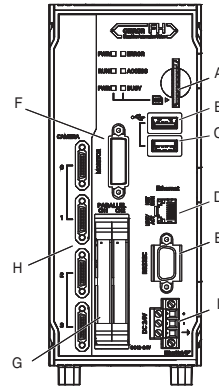
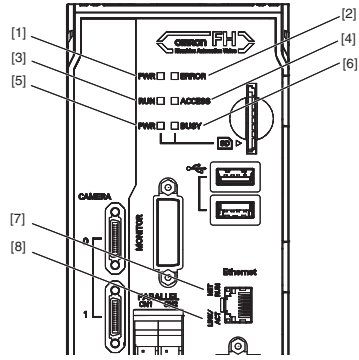

	LED name	Description
[1]	PWR LED	Lit while power is ON.
[2]	ERROR LED	Lit when an error has occurred.
[3]	RUN LED	Lit while the layout turned on output setting is displayed.
[4]	ACCESS LED	Blinks while the internal nonvolatile memory is accessed.
[5]	SD PWR LED	Lit while power is supplied to the SD memory card and the card is usable.
[6]	SD BUSY LED	Lit when access to the SD memory card.
[7]	Ethernet NET RUN LED	Lit while Ethernet communications are usable.
[8]	Ethernet NET LINK/ACT LED	Blinks when connected with an Ethernet device, and blinks while performing communications.

	Connector name	Description
A	SD memory card installation connector	Install the SD memory card. Do not plug or unplug the SD memory card during measurement operation. Otherwise measurement time may be affected or data may be destroyed.
B	USB 2.0 connector	Connects to USB 2.0. Do not insert or remove during loading or writing of measurement or data. The measurement time can be longer or data can be damaged.
C	USB 3.0 connector	Connects to USB 3.0. Do not insert or remove during loading or writing of measurement or data. The measurement time can be longer or data can be damaged. USB 3.0 has a high ability to supply the bus power. Use the Sensor Controller by combining USB 3.0, faster transport can be realized.
D	Ethernet connector	Connect an Ethernet device. Shared Ethernet port and EtherNet/IP port.
E	RS-232C connector	Connect an external device such as a programmable controller.
F	Monitor connector	Connect a monitor.
G	Parallel connector (control lines, data lines)	Connect the controller to external devices such as a sync sensor.
H	Camera connector	Connect a camera.
I	Power supply terminal connector	Connect a DC power supply. Wire the controller independently on other devices. Wire * the ground line. Be sure to ground the FH Sensor Controller alone.

* Use the attachment power terminal connector (male) of FH-XCN-L series.
For details, refer to 5-3 Sensor Controller Installation on Vision System FH/FZ5 series Hardware Setup Manual(Z366).

Processing Items

Group	Icon	Processing Item	Corresponding Page in the Catalog
Measurement		Search Used to identify the shapes and calculate the position of measurement objects.	P16
		Flexible Search Recognizing the shapes of workpieces with variation and detecting their positions.	P16
		Sensitive Search Search a small difference by dividing the search model in detail, and calculating the correlation.	P16
		ECM Search Used to search the similar part of model form input image. Detect the evaluation value and position.	
		EC Circle Search Extract circles using "round" shape information and get position, radius and quantity in high preciseness.	
		Shape Search II Used to search the similar part of model from input image regardless of environmental changes. Detect the evaluation value and position.	P16
		Shape Search III Robust detection of positions is possible at high-speed and with high precision incorporating environmental fluctuations, such as differences in individual shapes of the workpieces, pose fluctuations, noise superimposition and shielding.	P16
		EC Corner This processing item measures a corner position (corner) of a workpiece.	
		Ec Cross The center position of a crosshair shape is measured using the lines created by the edge information on each side of the crosshair.	
		Classification Used when various kinds of products on the assembly line need to be sorted and identified.	P16
		Edge Position Measure position of measurement objects according to the color change in measurement area.	P16
		Edge Pitch Detect edges by color change in measurement area. Used for calculating number of pins of IC and connectors.	P16
		Scan Edge Position Measure peak/bottom edge position of workpieces according to the color change in separated measurement area.	P16
		Scan Edge Width Measure max/min/average width of workpieces according to the color change in separated measurement area.	P16
		Circular Scan Edge Position Measure center axis, diameter and radius of circular workpieces.	P16
		Circular Scan Edge Width Measure center axis, width and thickness of ring workpieces.	P16
		Intersection Calculate approximate lines from the edge information on two sides of a square workpiece to measure the angle formed at the intersection of the two lines.	P16
		Color Data Used for detecting presence and mixed varieties of products by using color average and deviation.	
		Gravity and Area Used to measure area, center of gravity of workpieces by extracting the color to be measured.	
		Labeling Used to measure number, area and gravity of workpieces by extracting registered color.	
		Label Data Selecting one region of extracted Labeling, and get that measurement. Area and Gravity position can be got and judged.	
		Defect Used for appearance measurement of plain-color measurement objects such as defects, stains and burrs.	P16
		Precise Defect Check the defect on the object. Parameters for extraction defect can be set precisely.	P16
		Fine Matching Difference can be detected by overlapping and comparing (matching) registered fine images with input images.	P16
		Character Inspect Recognize character according correlation search with model image registered in [Model Dictionary].	P17
		Date Verification Reading character string is verified with internal date.	P17
		Model Dictionary Register character pattern as dictionary. The pattern is used in [Character Inspection].	
		2DCode *2 Recognize 2D code and display where the code quality is poor.	P17
		Barcode *1 Recognize barcode, verify and output decoded characters.	P17
		OCR Recognize and read characters in images as character information.	P17
		OCR User Dictionary Register dictionary data to use for OCR.	P17
		Circle Angle Used for calculating angle of inclination of circular measurement objects.	
		Glue Bead Inspection You can inspect coating of a specified color for gaps or runoffs along the coating path.	P17
Input Image		Camera Image Input FH To input images from cameras. And set up the conditions to input images from cameras. (For FH Sensor Controllers only)	
		Camera Image Input HDR Create high-dynamic range images by acquiring several images with different conditions.	

Group	Icon	Processing Item	Corresponding Page in the Catalog
Input Image		Camera Image Input HDRLite HDR function for FZ-SQ□ Intelligent Compact Cameras.	
		Camera Switch To switch the cameras used for measurement. Not input images from cameras again.	
		Measurement Image Switching To switch the images used for measurement. Not input images from camera again.	
		Position Compensation Used when positions are differed. Correct measurement is performed by correcting position of input images.	P18
		Filtering Used for processing images input from cameras in order to make them easier to be measured.	P18
		Background Suppression To enhance contrast of images by extracting color in specified brightness.	P18
		Brightness Correct Filter Track brightness change of entire screen and remove gradual brightness change such as uneven brightness.	P18
		Color Gray Filter Color image is converted into monochrome images to emphasize specific color.	P18
		Extract Color Filter Convert color image to color extracted image or binary image.	P18
		Anti Color Shading To remove the irregular color/pattern by uniformizing max.2 specified colors.	P18
Compensate image		Stripes Removal Filter II Remove the background pattern of vertical, horizontal and diagonal stripes.	P19
		Polar Transformation Rectify the image by polar transformation. Useful for OCR or pattern inspection printed on circle.	P18
		Trapezoidal Correction Rectify the trapezoidal deformed image.	P18
		Machine Simulator How the alignment marks would move on the image when each stage or robot axis is controlled can be checked.	
		Image Subtraction The registered model image and measurement image are compared and only the different pixels are extracted and converted to an image.	
		Advanced filter Process the images acquired from cameras in order to make them easier to measure. This processing item consolidates existing image conversion filtering into one processing item and adds extra functions.	P18
		Panorama Combine multiple image to create one big image.	P18
		Unit Macro Advanced arithmetic processing can be easily incorporated into workflow as Unit Macro processing items.	P20
		Unit Calculation Macro This function is convenient when the user wants to calculate a value using an original calculation formula or change the set value or system data of a processing item.	P20
		Calculation Used when using the judge results and measured values of Procltem which are registered in processing units.	
Support measurement		Line Regression Used for calculating regression line from plural measurement coordinate.	
		Circle Regression Used for calculating regression circle from plural measurement coordinate.	
		Precise Calibration Used for calibration corresponding to trapezoidal distortion and lens distortion.	P15
		User Data Used for setting of the data that can be used as common constants and variables in scene group data.	P21
		Set Unit Data Used to change the Procltem data (setting parameters, etc.) that has been set up in a scene.	
		Get Unit Data Used to get one data (measured results, setting parameters, etc.) of Procltem that has been set up in a scene.	
		Set Unit Figure Used for re-setting the figure data (model, measurement area) registered in an unit.	
		Get Unit Figure Used for get the figure data (model, measurement area) registered in an unit.	
		Trend Monitor Used for displaying the information about results on the monitor, facilitating to avoid NG and analyze causes.	P21
		Image Logging Used for saving the measurement images to the memory and USB memory.	
	Image Conversion Logging Used for saving the measurement images in JPEG and BMP format.		
	Data Logging Used for saving the measurement data to the memory and USB memory.		
	Elapsed Time Used for calculating the elapsed time since the measurement trigger input.		
	Wait Processing is stopped only at the set time. The standby time is set by the unit of [ms].		
	Focus Focus setting is supported.	P15	

Group	Icon	Processing Item	Corresponding Page in the Catalog
Support measurement		Iris Focus and aperture setting is supported.	P15
		Parallelize A part of the measurement flow is divided into two or more tasks and processed in parallel to shorten the measurement time. This processing item is placed at the top of processing to be performed in parallel.	
		Parallelize Task A part of the measurement flow is divided into two or more tasks and processed in parallel to shorten the measurement time. This processing item is placed immediately before processing to be performed in parallel between Parallelize and Parallelize End.	
		Statistics Used when you need to calculate an average of multiple measurement results.	
		Reference Calib Data Calibration data and distortion compensation data held under other processing items can be referenced.	
		Position Data Calculation The specified position angle is calculated from the measured positions.	P14
		Stage Data Sets and stores data related to stages.	
		Robot Data Sets and stores data related to robots.	
		Vision Master Calibration This processing item automatically calculates the entire axis movement amount of the control equipment necessary for calibration.	P15
		PLC Mastroer Calibration Calibration data is created using a communication command from PLC.	P15
		Convert Position Data The position angle after the specified axis movement is calculated.	P14
		Movement Single Position The axis movement that is required to match the measured position angle to the reference position angle is calculated.	P14
		Movement Multi Points The axis movements that are required to match the measured position angles to the corresponding reference position angles are calculated.	P14
		Detection Point Obtains position/angle information by referring to the coordinate values measured with the Measurement Processing Unit.	
		Camera Calibration By setting the camera calibration, the measurement result can be converted and output as actual dimensions.	P15
		Data Save The set data can be saved in the controller main unit or as scene data. The data is held even after the FH/FZ power is turned off.	
		Conveyor Calibration Conveyor Calibration is used to calibrate camera, conveyor, and robots for conveyor tracking application.	

Group	Icon	Processing Item	Corresponding Page in the Catalog
Branch		Conditional Branch Used where more than two kinds of products on the production line need to be detected separately.	
		End This Procltem must be set up as the last processing unit of a branch.	
		DI Branch Same as Procltem "Branch". But you can change the targets of conditional branching via external inputs.	
		Control Flow Normal Set the measurement flow processing into the wait state in which the specific no-protocol command can be executed.	
		Control Flow PLC Link Set the measurement flow processing into the wait state in which the specific PLC Link command can be executed.	
		Control Flow Parallel Set the measurement flow processing into the wait state in which the specific parallel command can be executed.	
		Control Flow Fieldbus Set the measurement flow processing into the wait state in which the specific Fieldbus command can be executed.	
Output results		Selective Branch Easily branch to multiple destinations.	
		Data Output Used when you need to output data to the external devices such as PLC or PC via serial ports.	
		Parallel Data Output Used when you need to output data to the external devices such as PLC or PC via parallel ports.	
		Parallel Judgement Output Used when you need to output judgement results to the external devices such as PLC or PC via parallel ports.	
Output result		Fieldbus Data Output Outputs data to an external device, such as a Programmable Controller, through a fieldbus interface.	
		Result Display Used for displaying the texts or the figures in the camera image.	
		Display Image File Display selected image file.	
		Display Last NG Image Display the last NG images.	
		Conveyor Panorama Display Display images of the tracking area as a panoramic image.	

- *1 Bar Codes that can be read : JAN/EAN/UPC (including add-on codes), Code 39, Codabar (NW-7), ITF (Interleaved 2 of 5), Code 93, Code 128, GS1-128, GS1 DataBar (RSS-14 / RSS Limited / RSS Expanded), Pharmacode
- *2 2D Codes that can be read : Data Matrix (ECC200), QR Code

Dimensions

(Unit: mm)

Sensor Controllers

High-speed Controllers/Standard Controllers

Box-type

FH-3050/-3050-10/-3050-20

FH-1050/-1050-10/-1050-20

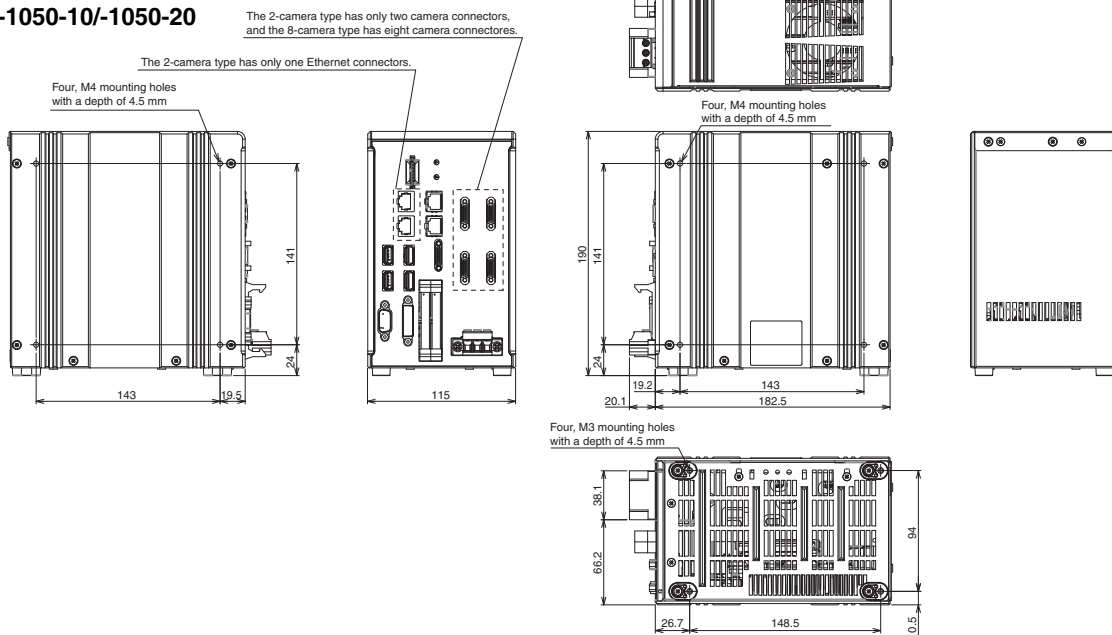

Lite Controllers
BOX type
FH-L550/-L550-10

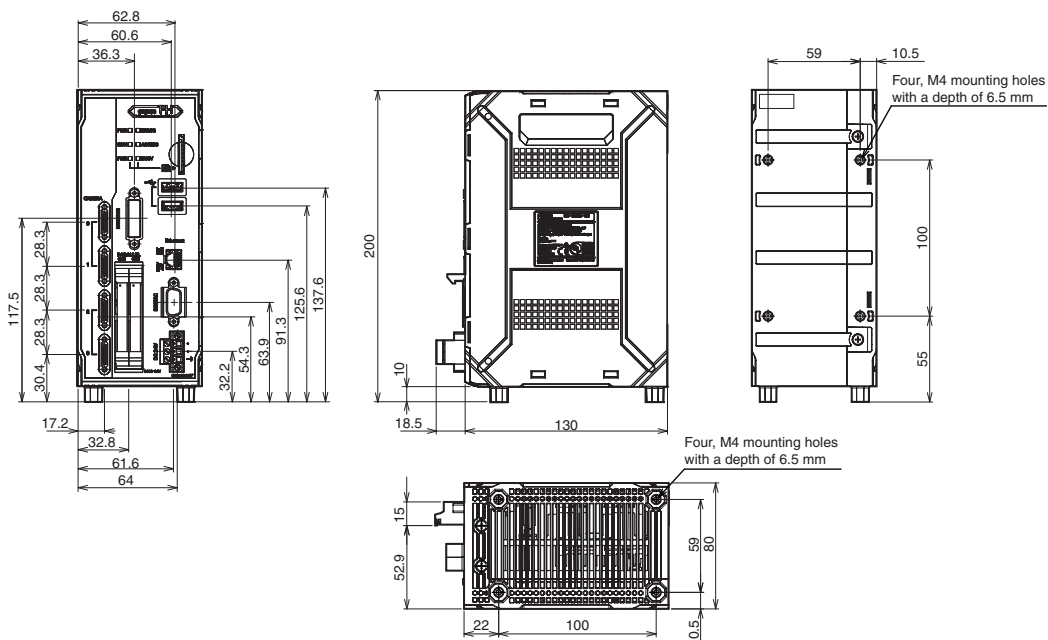

Cameras

High-speed Digital CMOS Camera

300,000-pixel camera

FH-SC
 FH-SM

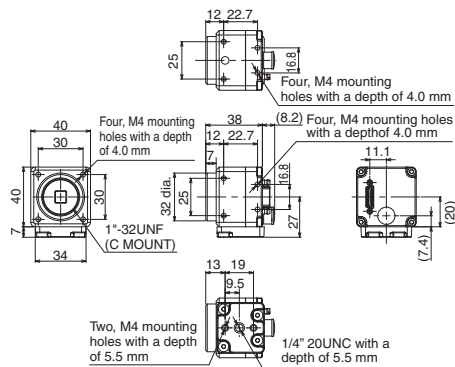

2 million-pixel camera

FH-SC02
 FH-SM02

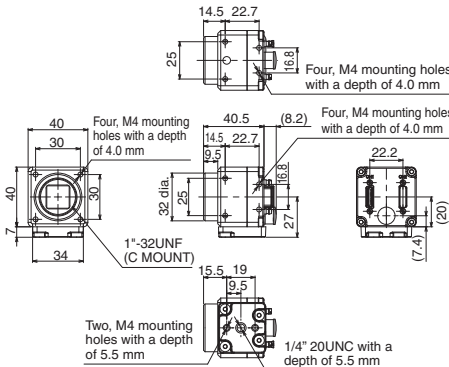

4 million-pixel camera

FH-SC04
 FH-SM04

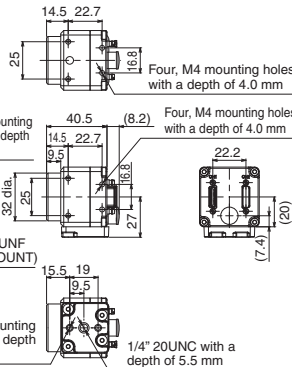

12 million-pixel camera

FH-SC12
 FH-SM12

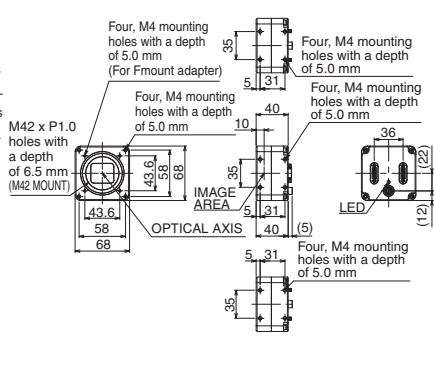

Digital CMOS Cameras

FH-SM05R
 FH-SC05R

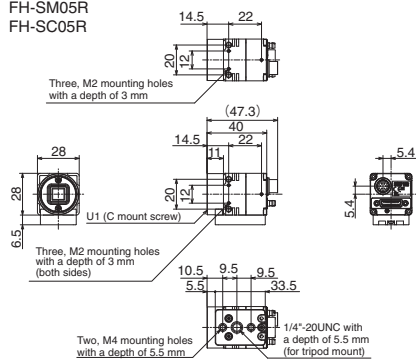

Digital CCD Cameras

300,000-pixel camera

FZ-S
FZ-SC

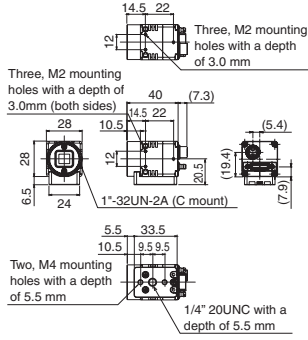

2 million-pixel camera

FZ-S2M
FZ-SC2M

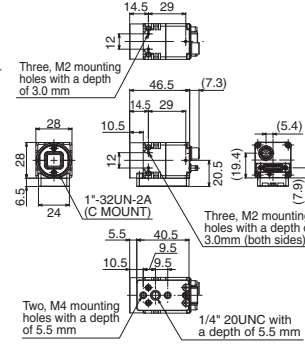

5 million-pixel camera

FZ-S5M2
FZ-SC5M2

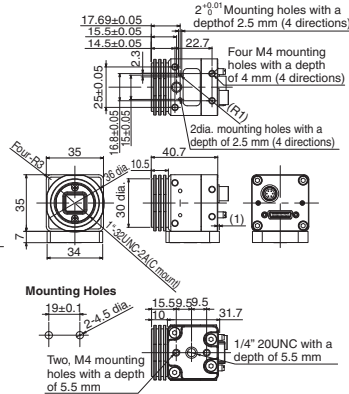

High-speed CCD Camera

FZ-SH
FZ-SHC

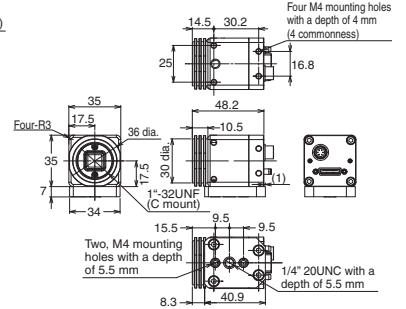

Small digital CCD cameras

Camera head

Flat camera
FZ-SF
FZ-SFC

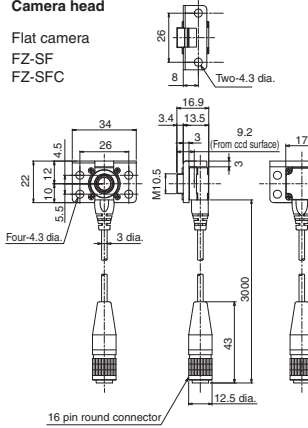

Pen-shaped camera

FZ-SP
FZ-SPC

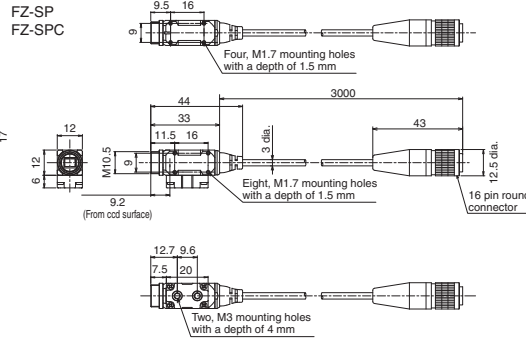

Camera amplifier

Can be used for both flat cameras and pen-shaped cameras

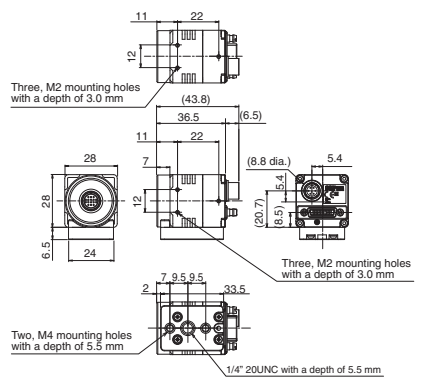

Intelligent Compact Digital CMOS Cameras

Narrow view / Standard

FZ-SQ010F
FZ-SQ050F

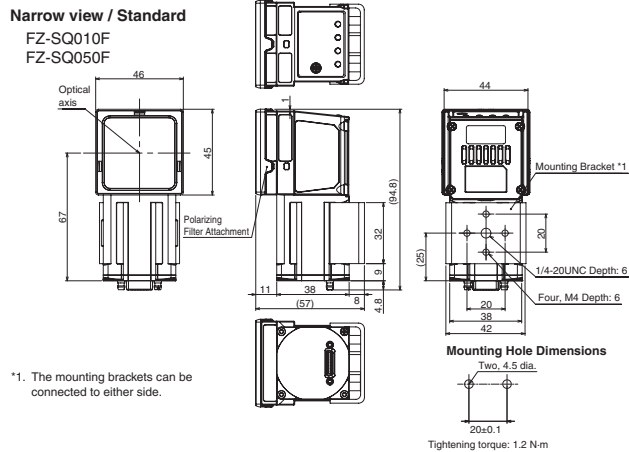

Wide View

FZ-SQ100F (long-distance)
FZ-SQ100N (short-distance)

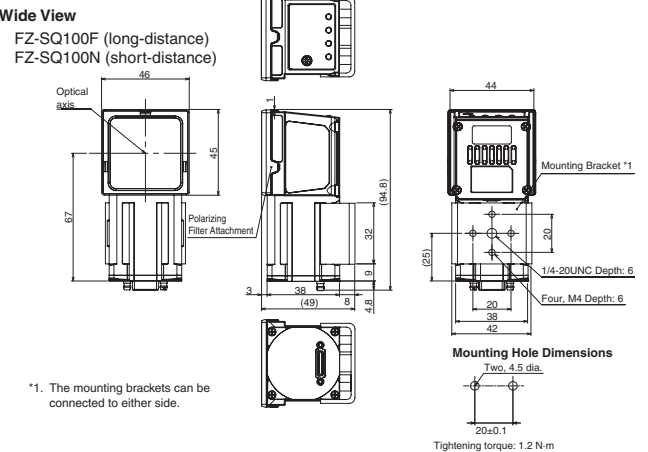

*1. The mounting brackets can be connected to either side.

*1. The mounting brackets can be connected to either side.

Cables

Camera Cable

Camera Cable
FZ-VS3

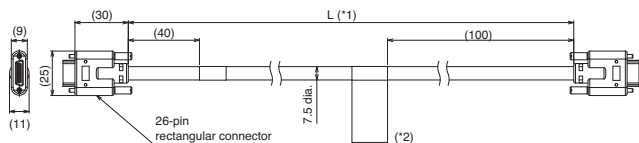

Bend resistant Camera Cable

FZ-VSB3

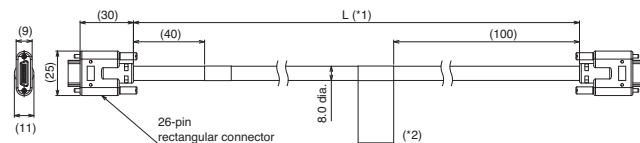

Right-angle Camera Cable

FZ-VSL3

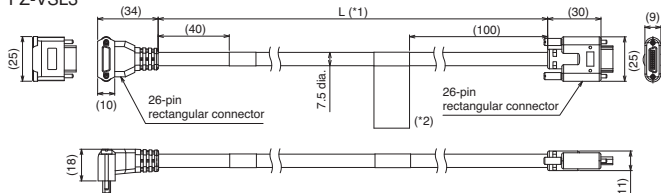

Bend resistant Right-angle Camera Cable

FZ-VSLB3

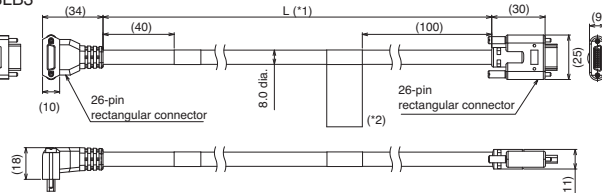

Long-distance Camera Cable

FZ-VS4

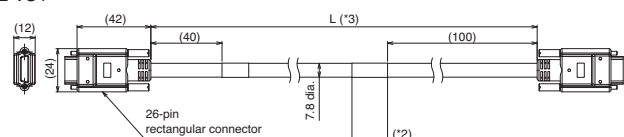

Long-distance Right-angle Camera Cable

FZ-VSL4

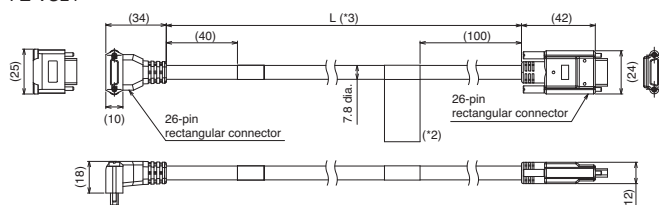

- *1. Cable is available in 2m/3m/5m/10m.
- *2. Each camera cables has polarity. Please ensure that the name plate side of the cable is connected to the controller.
- *3. Cable is available in 15m.

Camera Cable Extension Unit

FZ-VSJ

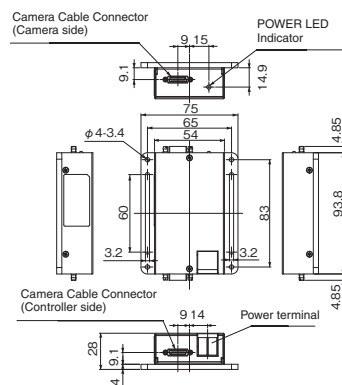

Extension Tubes for Small Camera

FZ-LESR

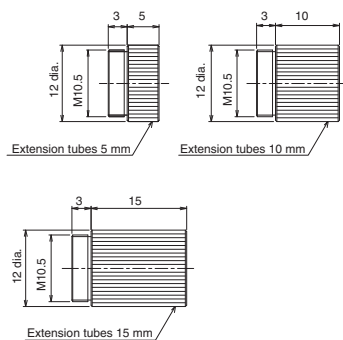

Lens for Small Camera

FZ-LES Series

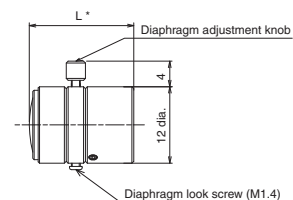

- * Overall length is available in 16.4mm/19.7mm/23.1mm/25.5mm.

Encoder Cable

FH-VR

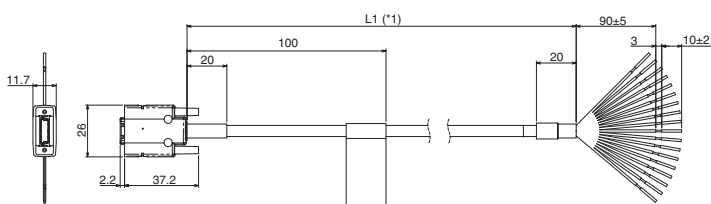

- *1. Cable is available in 1.5 m.

Parallel I/O Cable

XW2Z-S013-□

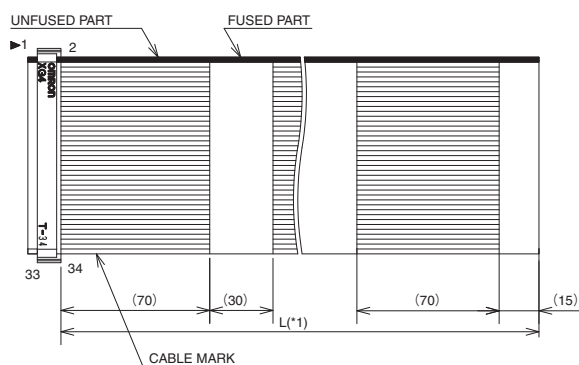

- *1. Cable is available in 2m/5m.

Touch Panel Monitor

FH-MT12

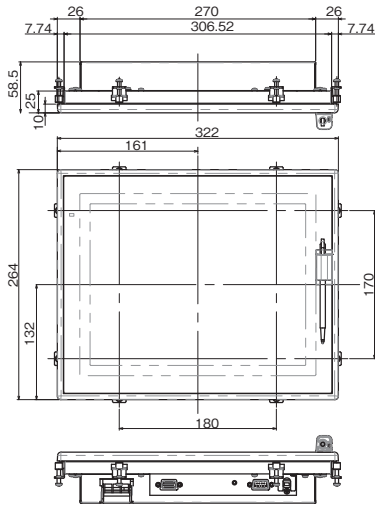

Panel cutout dimensions

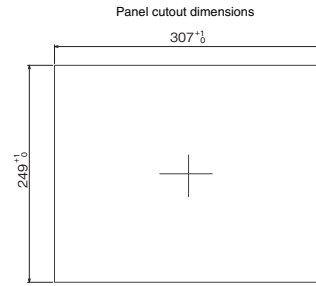

Note:1. Panel thickness : 1.6 to 4.8 mm
2. No burr allowed

DVI-Analog Conversion Cable for Touch Panel Monitor

FH-VMDA

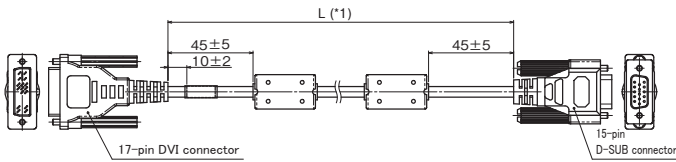

RS-232C Cable for Touch Panel Monitor

XW2Z-□□□PP-1

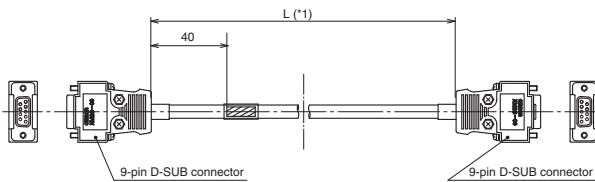

USB Cable for Touch Panel Monitor

FH-VUAB

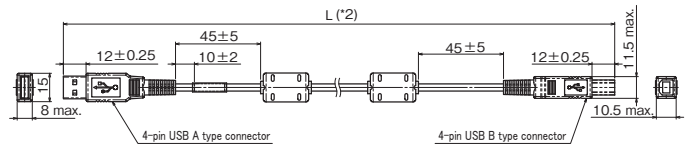

*1. Cable is available in 2m/5m/10m.
*2. Cable is available in 2m/5m.

LCD Monitor

FZ-M08

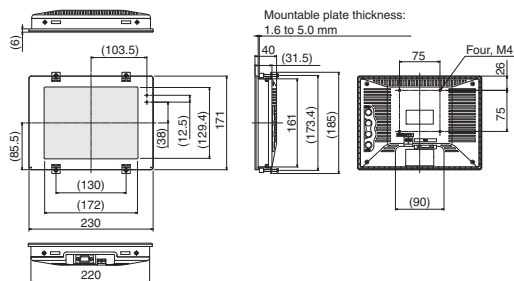

LCD Monitor Cable

FZ-VM

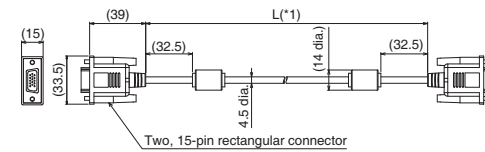

*1. Cable is available in 2m/5m.

DVI-I -RGB Conversion Connector

FH-VMRGB

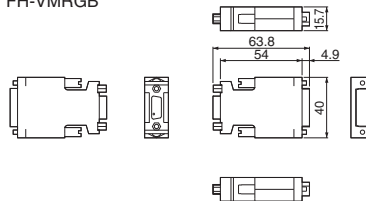

Optical Chart

Meaning of Optical Chart

The X axis of the optical chart shows the field of vision (mm) (*1), and the Y axis of the optical chart shows the camera installation distance (mm) (*2).

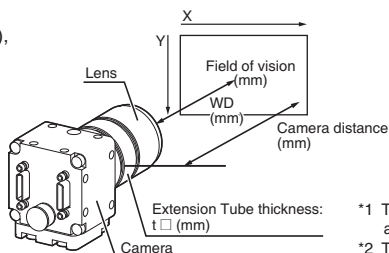

*1 The lengths of the fields of vision given in the optical charts are the lengths of the Y axis.
*2 The vertical axis represents WD for small cameras.

Normal Lenses

High-speed Digital CMOS Camera
FH-S□,
High-speed Digital CCD Camera
FZ-SH□,
Digital CCD Camera
FZ-S□,
300,000-pixel
(Using 3Z4S-LE SV-V Series)

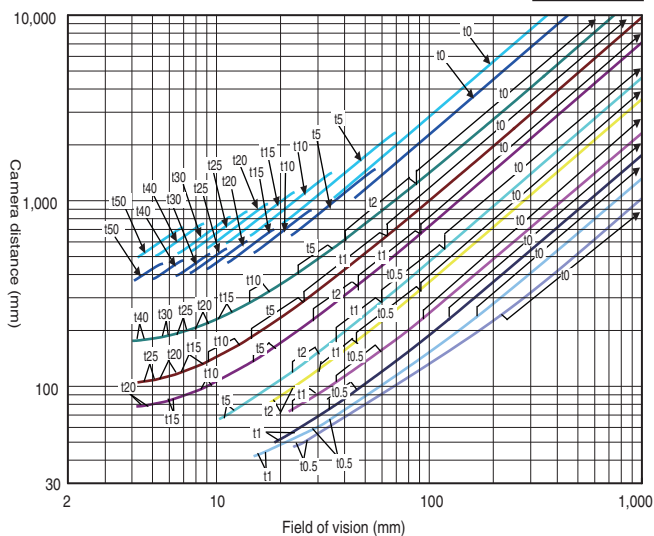
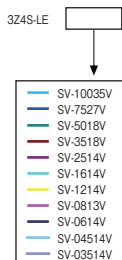

Digital CCD Camera
FZ-S□5M2,
5 million-pixel
(Using 3Z4S-LE SV-H Series)

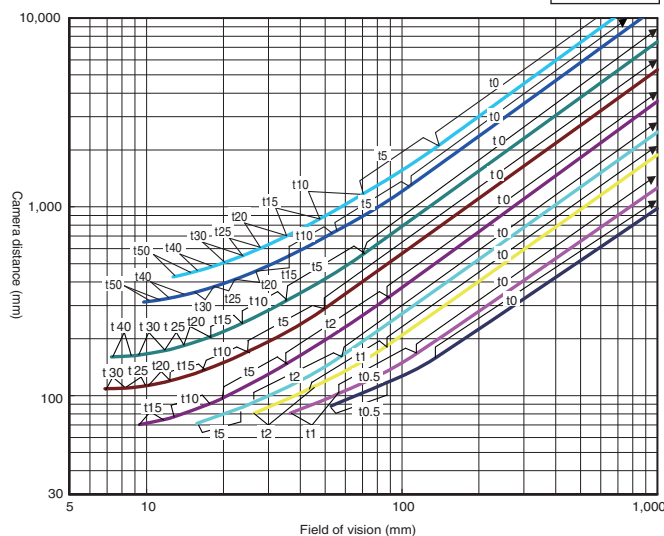

Digital CCD Camera
FZ-S□2M,
2 million-pixel
(Using 3Z4S-LE SV-H Series)

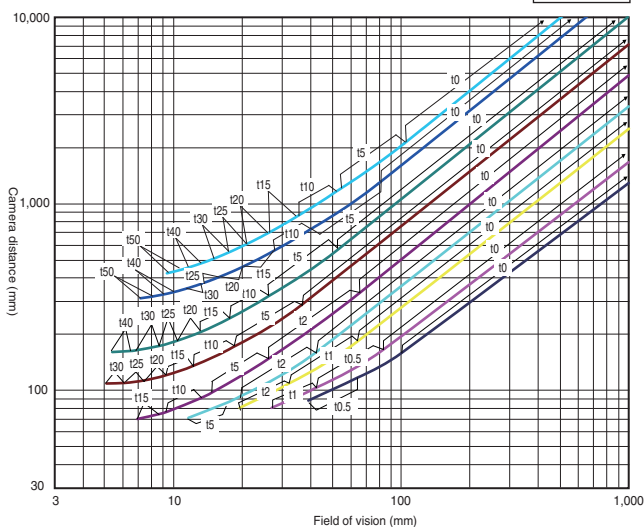

Digital CMOS Camera (Standalone):
FH-S□05R
5 million-pixel
(Using 3Z4S-LE SV-H Series)

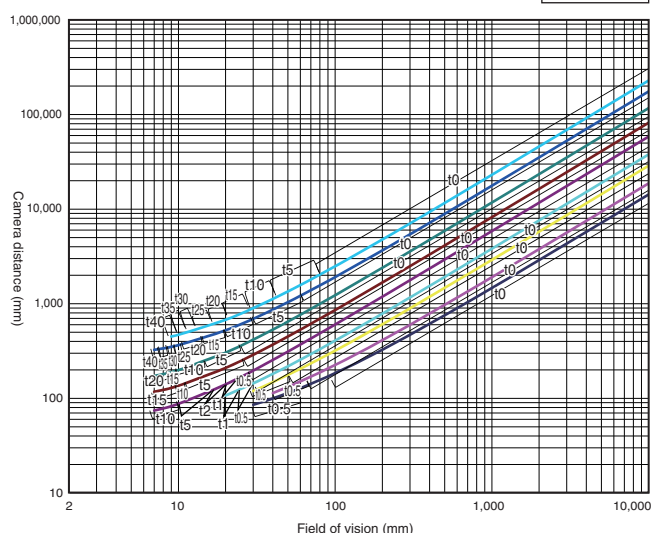
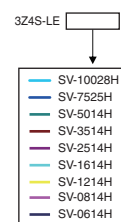

Small Digital CCD Cameras FZ-S□□, FZ-SP□, 300,000-pixel (Using FZ-LES Series)

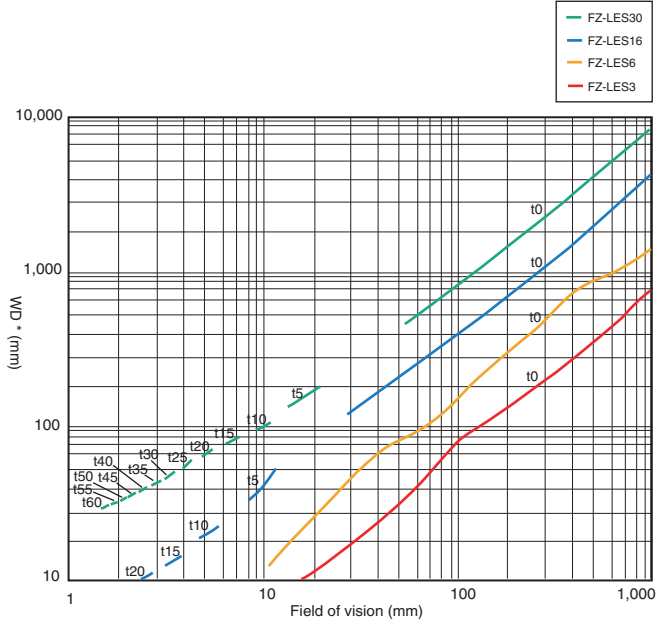

High-speed Digital CMOS Camera FH-S□04, 4 million-pixel (Using 3Z4S-LE VS-H1 Series)

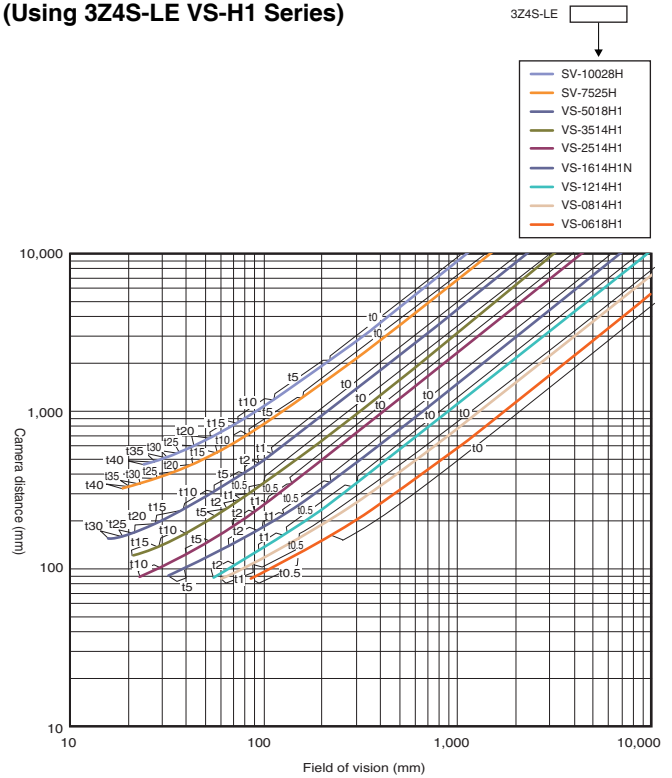

High-speed Digital CMOS Camera FH-S□02, 2million-pixel (Using 3Z4S-LE VS-H1 Series)

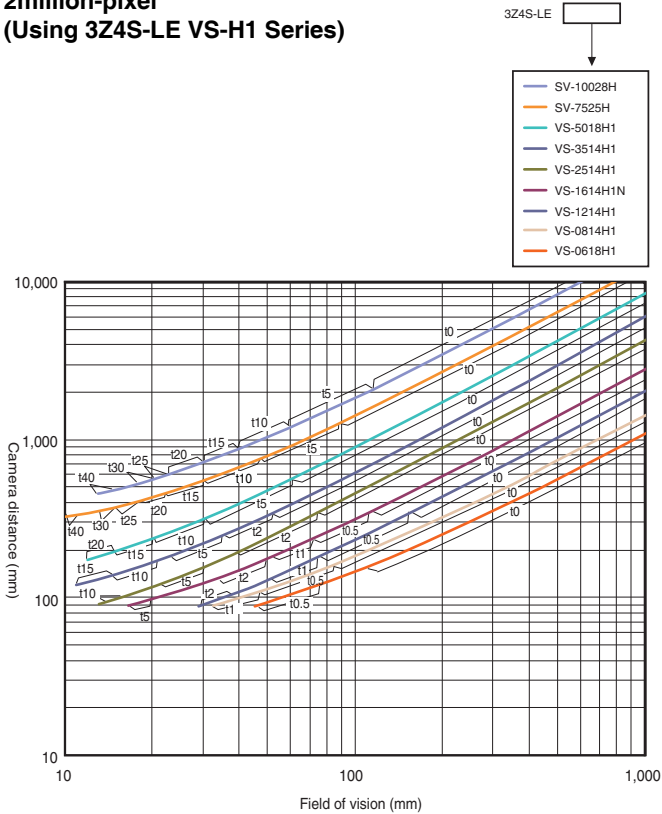

High-speed Digital CMOS Camera FH-S□12, 12 million-pixel (Using 3Z4S-LE VS-L/M42 Series)

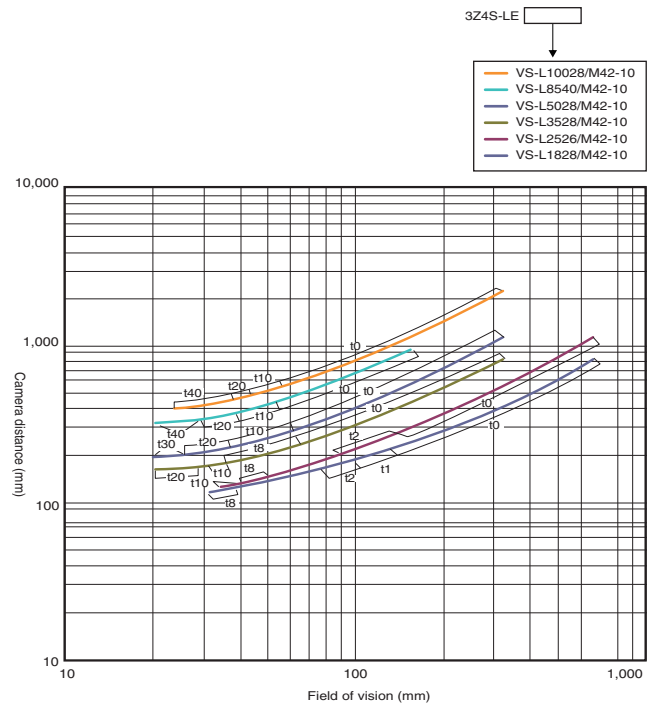

Vibration/Shock-resistance Lens

High-speed Digital CMOS Camera
 FH-S□,
 High-speed Digital CCD Camera
 FZ-SH□,
 Digital CCD Camera
 FZ-S□,
 300,000-pixel
 (Using 3Z4S-LE VS-MC Series)

3Z4S-LE □

- VS-MC75
- VS-MC50
- VS-MC35
- VS-MC30
- VS-MC25N
- VS-MC20
- VS-MC15

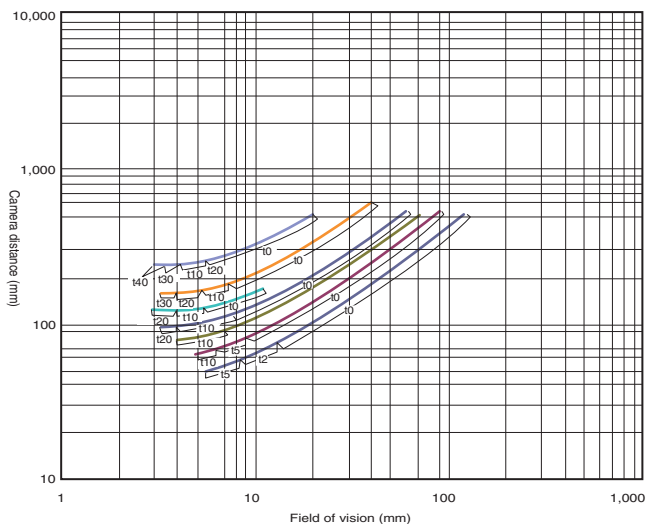

Digital CCD Camera
 FZ-S□5M2,
 5 million-pixel
 (Using 3Z4S-LE VS-MC Series)

3Z4S-LE □

- VS-MC75
- VS-MC50
- VS-MC35
- VS-MC30
- VS-MC25N
- VS-MC20
- VS-MC15

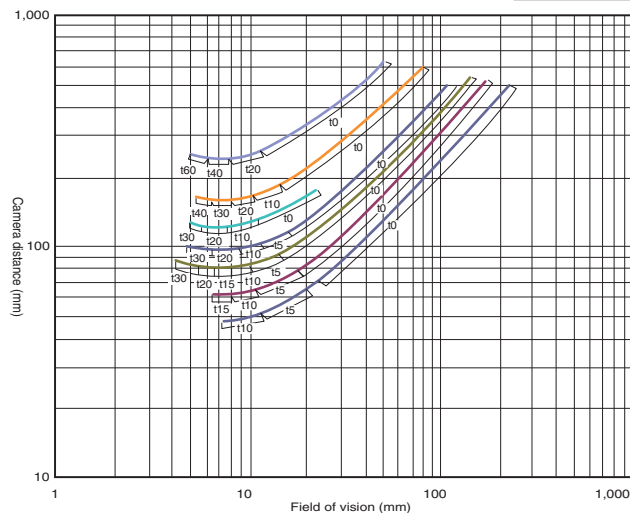

Digital CCD Camera
 FZ-S□2M,
 2 million-pixel
 (Using 3Z4S-LE VS-MC Series)

3Z4S-LE □

- VS-MC75
- VS-MC50
- VS-MC35
- VS-MC30
- VS-MC25N
- VS-MC20
- VS-MC15

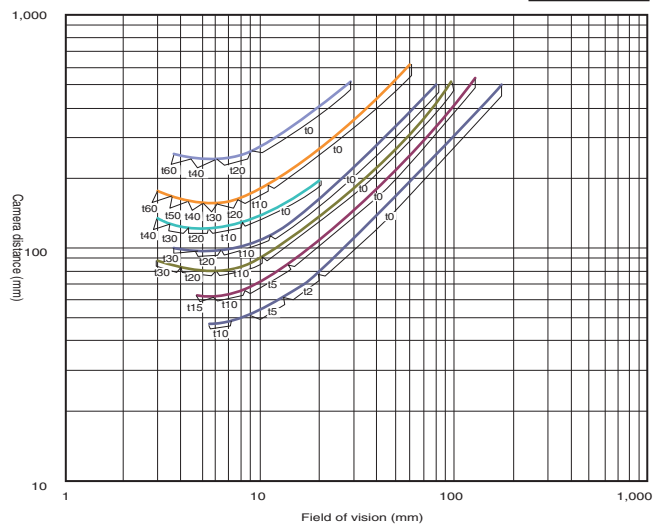

Digital CMOS Camera (Standalone)
 FH-S□05R,
 5 million-pixel
 (Using 3Z4S-LE VS-MC Series)

3Z4S-LE □

- VS-MC75
- VS-MC50
- VS-MC35
- VS-MC30
- VS-MC25N
- VS-MC20
- VS-MC15
- VS-MC10
- VS-MC6.5
- VS-MC4

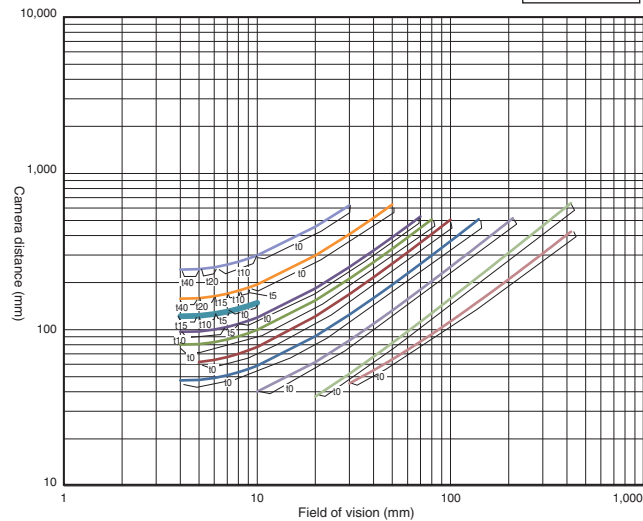

High-speed Digital CMOS Camera (Standalone)
FH-S□02
2 million-pixel
(Using 3Z4S-LE VS-MCH Series)

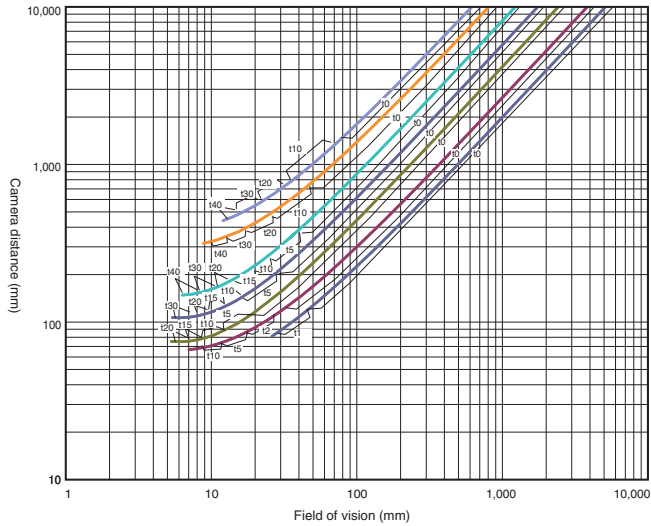
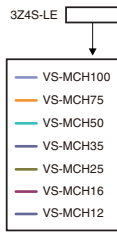

High-speed Digital CMOS Camera (Standalone)
FH-S□04
4 million-pixel
(Using 3Z4S-LE VS-MCH Series)

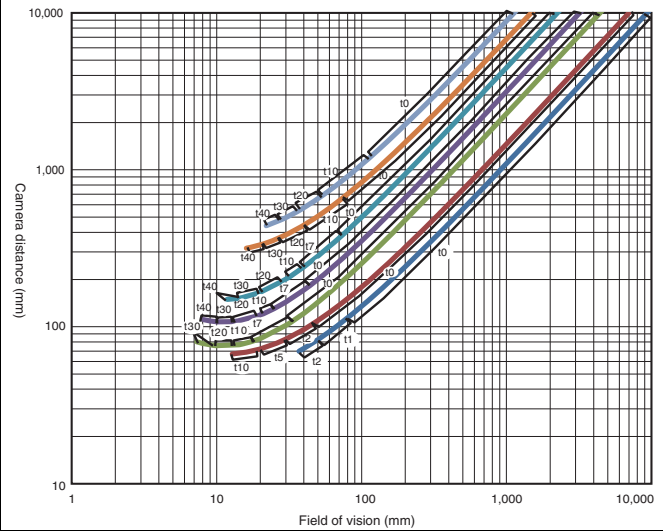
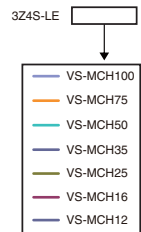

High-speed Digital CMOS Camera (Standalone)
FH-S□12
12 million-pixel
(Using 3Z4S-LE VS-MCL/M42 Series)

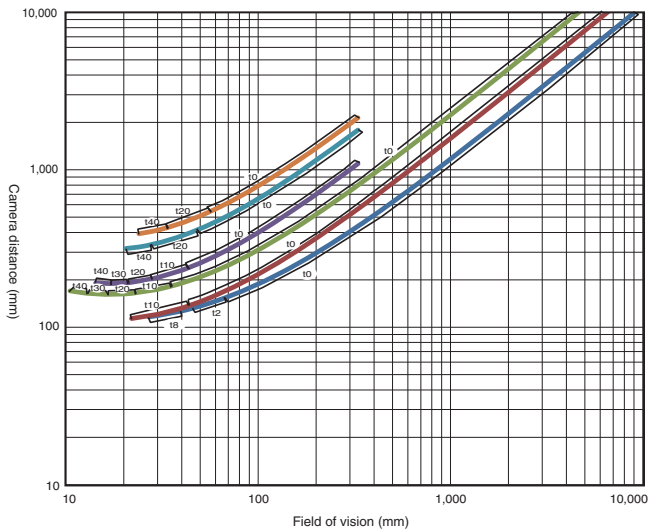
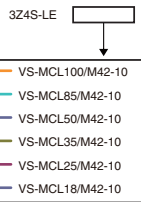

Related Manuals

Man.No.	Model number	Manual
Z365	FH/FZ5	Vision System FH/FZ5 Series User's Manual
Z341	FH/FZ5	Vision System FH/FZ5 series Processing Item Function Reference Manual
Z342	FH/FZ5	Vision System FH/FZ5 Series User's Manual for Communications Settings
Z343	FH	Vision System FH Series Operation Manual for Sysmac Studio
Z366	FH/FZ5	Vision System FH/FZ5 series Hardware Setup Manual
Z367	FH/FZ5	Vision System FH/FZ5 series Macro Customize Functions Programming Manual

Terms and Conditions Agreement

Read and understand this catalog.

Please read and understand this catalog before purchasing the products. Please consult your OMRON representative if you have any questions or comments.

Warranties.

- (a) Exclusive Warranty. Omron's exclusive warranty is that the Products will be free from defects in materials and workmanship for a period of twelve months from the date of sale by Omron (or such other period expressed in writing by Omron). Omron disclaims all other warranties, express or implied.
- (b) Limitations. OMRON MAKES NO WARRANTY OR REPRESENTATION, EXPRESS OR IMPLIED, ABOUT NON-INFRINGEMENT, MERCHANTABILITY OR FITNESS FOR A PARTICULAR PURPOSE OF THE PRODUCTS. BUYER ACKNOWLEDGES THAT IT ALONE HAS DETERMINED THAT THE PRODUCTS WILL SUITABLY MEET THE REQUIREMENTS OF THEIR INTENDED USE.

Omron further disclaims all warranties and responsibility of any type for claims or expenses based on infringement by the Products or otherwise of any intellectual property right. (c) Buyer Remedy. Omron's sole obligation hereunder shall be, at Omron's election, to (i) replace (in the form originally shipped with Buyer responsible for labor charges for removal or replacement thereof) the non-complying Product, (ii) repair the non-complying Product, or (iii) repay or credit Buyer an amount equal to the purchase price of the non-complying Product; provided that in no event shall Omron be responsible for warranty, repair, indemnity or any other claims or expenses regarding the Products unless Omron's analysis confirms that the Products were properly handled, stored, installed and maintained and not subject to contamination, abuse, misuse or inappropriate modification. Return of any Products by Buyer must be approved in writing by Omron before shipment. Omron Companies shall not be liable for the suitability or unsuitability or the results from the use of Products in combination with any electrical or electronic components, circuits, system assemblies or any other materials or substances or environments. Any advice, recommendations or information given orally or in writing, are not to be construed as an amendment or addition to the above warranty.

See <http://www.omron.com/global/> or contact your Omron representative for published information.

Limitation on Liability; Etc.

OMRON COMPANIES SHALL NOT BE LIABLE FOR SPECIAL, INDIRECT, INCIDENTAL, OR CONSEQUENTIAL DAMAGES, LOSS OF PROFITS OR PRODUCTION OR COMMERCIAL LOSS IN ANY WAY CONNECTED WITH THE PRODUCTS, WHETHER SUCH CLAIM IS BASED IN CONTRACT, WARRANTY, NEGLIGENCE OR STRICT LIABILITY.

Further, in no event shall liability of Omron Companies exceed the individual price of the Product on which liability is asserted.

Suitability of Use.

Omron Companies shall not be responsible for conformity with any standards, codes or regulations which apply to the combination of the Product in the Buyer's application or use of the Product. At Buyer's request, Omron will provide applicable third party certification documents identifying ratings and limitations of use which apply to the Product. This information by itself is not sufficient for a complete determination of the suitability of the Product in combination with the end product, machine, system, or other application or use. Buyer shall be solely responsible for determining appropriateness of the particular Product with respect to Buyer's application, product or system. Buyer shall take application responsibility in all cases.

NEVER USE THE PRODUCT FOR AN APPLICATION INVOLVING SERIOUS RISK TO LIFE OR PROPERTY OR IN LARGE QUANTITIES WITHOUT ENSURING THAT THE SYSTEM AS A WHOLE HAS BEEN DESIGNED TO ADDRESS THE RISKS, AND THAT THE OMRON PRODUCT(S) IS PROPERLY RATED AND INSTALLED FOR THE INTENDED USE WITHIN THE OVERALL EQUIPMENT OR SYSTEM.

Programmable Products.

Omron Companies shall not be responsible for the user's programming of a programmable Product, or any consequence thereof.

Performance Data.

Data presented in Omron Company websites, catalogs and other materials is provided as a guide for the user in determining suitability and does not constitute a warranty. It may represent the result of Omron's test conditions, and the user must correlate it to actual application requirements. Actual performance is subject to the Omron's Warranty and Limitations of Liability.

Change in Specifications.

Product specifications and accessories may be changed at any time based on improvements and other reasons. It is our practice to change part numbers when published ratings or features are changed, or when significant construction changes are made. However, some specifications of the Product may be changed without any notice. When in doubt, special part numbers may be assigned to fix or establish key specifications for your application. Please consult with your Omron's representative at any time to confirm actual specifications of purchased Product.

Errors and Omissions.

Information presented by Omron Companies has been checked and is believed to be accurate; however, no responsibility is assumed for clerical, typographical or proofreading errors or omissions.

Sysmac is a trademark or registered trademark of OMRON corporation in Japan and other countries for OMRON factory automation products.

Think&See is a trademark or registered trademark of OMRON Corporation in Japan and other countries.

EtherCAT® is registered trademark and patented technology, licensed by Beckhoff Automation GmbH, Germany.

Windows, Microsoft® Visual Studio® are either registered trademarks or trademarks of Microsoft Corporation in the United States and/or other countries.

The Microsoft .NET software is used to connect users, information, systems, and devices.

QR Code is registered trademarks of DENSO WAVE INCORPORATED in Japan and in other countries.

Other company names and product names in this document are the trademarks or registered trademarks of their respective companies.

The product photographs and figures that are used in this catalog may vary somewhat from the actual products.

Microsoft product screen shot(s) reprinted with permission from Microsoft Corporation.

Note: Do not use this document to operate the Unit.

OMRON Corporation Industrial Automation Company
Kyoto, JAPAN

Contact: www.ia.omron.com

Regional Headquarters

OMRON EUROPE B.V.

Wegalaan 67-69, 2132 JD Hoofddorp
The Netherlands

Tel: (31)2356-81-300/Fax: (31)2356-81-388

OMRON ELECTRONICS LLC

2895 Greenspoint Parkway, Suite 200
Hoffman Estates, IL 60169 U.S.A.

Tel: (1) 847-843-7900/Fax: (1) 847-843-7787

OMRON ASIA PACIFIC PTE. LTD.

No. 438A Alexandra Road # 05-05/08 (Lobby 2),
Alexandra Technopark,
Singapore 119967

Tel: (65) 6835-3011/Fax: (65) 6835-2711

OMRON (CHINA) CO., LTD.

Room 2211, Bank of China Tower,
200 Yin Cheng Zhong Road,
PuDong New Area, Shanghai, 200120, China

Tel: (86) 21-5037-2222/Fax: (86) 21-5037-2200

Authorized Distributor:

© OMRON Corporation 2013-2016 All Rights Reserved.
In the interest of product improvement,
specifications are subject to change without notice.

CSM_18_1_0117
Cat. No.Q197-E1-06

0316 (0613)