

CJ Series EtherNet/IP™ Connection Guide

**OMRON Corporation
Vision System
(FH Series)**

About Intellectual Property Rights and Trademarks

Microsoft product screen shots reprinted with permission from Microsoft Corporation.

Windows is a registered trademark of Microsoft Corporation in the USA and other countries.

ODVA and EtherNet/IP[™] are trademarks of ODVA.

Company names and product names in this document are the trademarks or registered trademarks of their respective companies.

Table of Contents

1. Related Manuals	1
2. Terms and Definitions	2
3. Precautions	3
4. Overview	4
5. Applicable Devices and Device Configuration	5
5.1. Applicable Devices	5
5.2. Device Configuration	6
6. EtherNet/IP Settings	8
6.1. Parameters	8
6.2. Allocating the Tag Data Links	10
7. EtherNet/IP Connection Procedure	12
7.1. Work Flow	12
7.2. Setting up the FH Sensor Controller	13
7.3. Setting up the PLC	19
7.4. Setting up the Network	28
7.5. Checking the EtherNet/IP Communications.....	42
8. Initialization Method	47
8.1. Initializing the PLC.....	47
8.2. Initializing the FH Sensor Controller.....	48
9. Revision History	49

1. Related Manuals

To ensure system safety, make sure to always read and heed the information provided in all Safety Precautions and Precautions for Safe Use of manuals for each device which is used in the system.

The table below lists the manuals of OMRON Corporation (hereinafter referred to as OMRON) related to this document.

Manufacturer	Cat. No.	Model	Manual name
OMRON	W472	CJ2M-CPU[] CJ2H-CPU6[] CJ2H-CPU6[]-EIP	CJ-series CJ2 CPU Unit Hardware User's Manual
OMRON	W473	CJ2M-CPU[] CJ2H-CPU6[] CJ2H-CPU6[]-EIP	CJ-series CJ2 CPU Unit Software User's Manual
OMRON	W465	CJ1W-EIP21 CJ2H-CPU6[]-EIP CJ2M-CPU3[]	EtherNet/IP™ Units Operation Manual
OMRON	W446	-	CX-Programmer Operation Manual
OMRON	0969584-7	W4S1-05[] W4S1-03B	Switching Hub W4S1-series User's Manual
OMRON	2285550-0	FH-1050/3050 FH-1050/3050-[]0	Image Processing System Instruction Sheet
OMRON	Z340	FH-1050/3050 FH-1050/3050-[]0	Vision Sensor FH/FZ5 Series Vision System User's Manual
OMRON	Z341	FH-1050/3050 FH-1050/3050-[]0	Vision Sensor FH/FZ5 Series Vision System Processing Item Function Reference Manual
OMRON	Z342	FH-1050/3050 FH-1050/3050-[]0	Vision Sensor FH/FZ5 Series Vision System User's Manual for Communications Settings
OMRON	Z343	FH-1050/3050 FH-1050/3050-[]0	Vision Sensor FH Series Vision System Operation Manual for Sysmac Studio
OMRON	1636843-6	FZ-M08	LCD monitor Instruction Sheet

2. Terms and Definitions

Term	Explanation and Definition
Node	<p>Programmable controllers and devices are connected to the EtherNet/IP network via the EtherNet/IP ports. The EtherNet/IP recognizes each EtherNet/IP port connected to the network as one node.</p> <p>When a device with two EtherNet/IP ports is connected to the EtherNet/IP network, the EtherNet/IP recognizes this device as two nodes.</p> <p>The EtherNet/IP achieves the communications between programmable controllers or the communications between programmable controllers and devices by exchanging data between these nodes connected to the network.</p>
Tag	<p>A minimum unit of the data that is exchanged on the EtherNet/IP network is called a tag. The tag is defined as a network variable or as a physical address, and it is allocated to the memory area of each device.</p>
Tag Set	<p>In the EtherNet/IP network, a data unit that consists of two or more tags can be exchanged. The data unit consisting of two or more tags for the data exchange is called a tag set. Up to eight tags can be configured per tag set for OMRON programmable controllers.</p>
Tag data link	<p>In the EtherNet/IP, the tag and tag set can be exchanged cyclically between nodes without using the user program. This standard feature on the EtherNet/IP is called a tag data link.</p>
Connection	<p>A connection is used to exchange data as a unit within which data concurrency is maintained. The connection consists of tags or tag sets. Creating the concurrent tag data link between the specified nodes is called a "connection establishment". When the connection is established, the tags or tag sets that configure the connection are exchanged between the specified nodes concurrently.</p>
Originator and Target	<p>To perform tag data links, one node requests the opening of a communications line called a "connection".</p> <p>The node that requests to open the connection is called an "originator", and the node that receives the request is called a "target".</p>
Tag data link parameter	<p>The tag data link parameter is the setting data to perform the tag data link. It includes the data to set tags, tag sets, and connections.</p>

3. Precautions

- (1) Understand the specifications of devices which are used in the system. Allow some margin for ratings and performance. Provide safety measures, such as installing safety circuit in order to ensure safety and minimize risks of abnormal occurrence.
- (2) To ensure system safety, make sure to always read and heed the information provided in all Safety Precautions and Precautions for Safe Use of manuals for each device which is used in the system.
- (3) The user is encouraged to confirm the standards and regulations that the system must conform to.
- (4) It is prohibited to copy, to reproduce, and to distribute a part or the whole of this document without the permission of OMRON Corporation.
- (5) The information contained in this document is current as of March 2015. It is subject to change without notice for improvement.

The following notation is used in this document.



Indicates a potentially hazardous situation which, if not avoided, may result in minor or moderate injury or property damage.



Precautions for Correct Use

Precautions on what to do and what not to do to ensure proper operation and performance.



Additional Information

Additional information to read as required.

This information is provided to increase understanding or make operation easier.

Symbol



The triangle symbol indicates precautions (including warnings).
The specific operation is shown in the triangle and explained in text.
This example indicates a general precaution.

4. Overview

This document describes the procedure for connecting the Vision System (FH series) of OMRON Corporation with CJ-series Programmable Controller + Ethernet/IP Unit (hereinafter referred to as the PLC) via EtherNet/IP, and the procedure to check their connection. Refer to *Section 6. EtherNet/IP Settings* and *Section 7. EtherNet/IP Connection Procedure* to understand the setting method and key points to perform the tag data links for the EtherNet/IP. In this document, CJ-series EtherNet/IP Unit and the built-in EtherNet/IP port of CJ-series CJ2 CPU Unit are collectively called as the "EtherNet/IP Unit".

5. Applicable Devices and Device Configuration

5.1. Applicable Devices

The applicable devices are as follows:

Manufacturer	Name	Model
OMRON	CJ2 CPU Unit	CJ2[]-CPU[[]]
OMRON	EtherNet/IP Unit	CJ1W-EIP21 CJ2H-CPU6[]-EIP CJ2M-CPU3[]
OMRON	FH Sensor Controller	FH-1050/3050 FH-1050/3050-[]0
OMRON	12 Megapixel High-Speed Camera 4 Megapixel High-Speed Camera 2 Megapixel High-Speed Camera 0.3 Megapixel High-Speed Camera 5 Megapixel Digital Camera 2 Megapixel Digital Camera 0.3 Megapixel Digital Camera 0.3 Megapixel High-Speed Camera 0.3 Megapixel Small Digital Camera 0.3 Megapixel Small Digital Pen-Shaped Camera Intelligent Compact Camera	FH-SC12/SM12 FH-SC04/SM04 FH-SC02/SM02 FH-SC/SM FZ-SC5M2/S5M2 FZ-SC2M/S2M FZ-SC/S FZ-SHC/SH FZ-SFC/SF FZ-SPC/SP FZ-SQ010F/SQ050F FZ-SQ100F/SQ100N



Precautions for Correct Use

As applicable devices above, the devices with the models and versions listed in *Section 5.2.* are actually used in this document to describe the procedure for connecting devices and checking the connection.

You cannot use devices with versions lower than the versions listed in *Section 5.2.*

To use the above devices with models not listed in *Section 5.2.* or versions higher than those listed in *Section 5.2.*, check the differences in the specifications by referring to the manuals before operating the devices.



Additional Information

This document describes the procedure to establish the network connection. It does not provide information on operation, installation or wiring method which is not related to the connection procedure. It also does not describe the functionality or operation of the devices. Refer to the manuals or contact your OMRON representative.

5.2. Device Configuration

The hardware components to reproduce the connection procedure of this document are as follows:

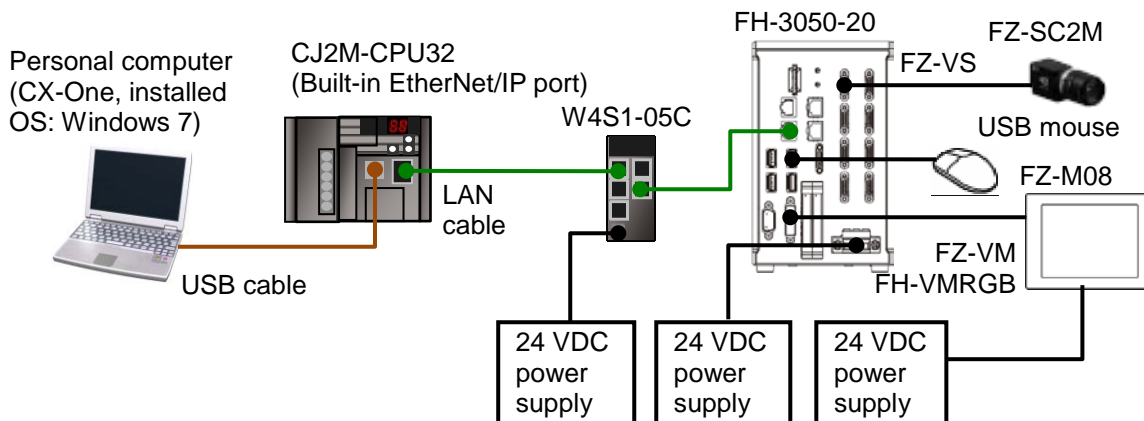

Manufacturer	Name	Model	Version
OMRON	CPU Unit (Built-in EtherNet/IP port)	CJ2M-CPU32	Ver.2.0 (Ver.2.12)
OMRON	Power Supply Unit	CJ1W-PA202	
OMRON	Switching hub	W4S1-05C	Ver.1.00
-	24 VDC power supply (For Switching hub)	-	
OMRON	CX-One	CXONE-AL[]C-V4 /AL[]D-V4	Ver.4.[]
OMRON	CX-Programmer	(Included in CX-One)	Ver.9.52
OMRON	Network Configurator	(Included in CX-One)	Ver.3.56
-	Personal computer (OS: Windows 7)	-	
-	USB cable (USB 2.0 type B connector)	-	
-	LAN cable (STP (shielded, twisted-pair) cable of Ethernet category 5 or higher)	-	
OMRON	FH Sensor Controller	FH-3050-20	Ver.5.32
OMRON	Camera	FZ-SC2M	
OMRON	Camera cable	FZ-VS[]	
OMRON	Monitor (Analog RGB monitor)	FZ-M08	
OMRON	Monitor cable	FZ-VM	
OMRON	Monitor conversion connector	FH-VMRGB	
-	USB mouse	-	
-	24 VDC power supply (For FH Sensor Controller)	-	
-	24 VDC power supply (For Monitor)	-	



Precautions for Correct Use

Update the CX-Programmer and Network Configurator to the versions specified in this section or higher versions using the auto update function.

If a version not specified in this section is used, the procedures described in *Section 7.* and subsequent sections may not be applicable. In that case, use the equivalent procedures described in this document by referring the *CX-Programmer Operation Manual* (Cat. No. W446) and Network Configurator Online Help.



Additional Information

For specifications of the 24 VDC power supply available for the Switching hub, refer to the *Switching Hub W4S1-series User's Manual* (Cat. No. 0969584-7).



Additional Information

For specifications of the 24 VDC power supply available for the FH Sensor Controller, refer to the *Image Processing System Instruction Sheet* (Cat. No. 2285550-0).



Additional Information

For specifications of the 24 VDC power supply available for the Monitor, refer to the *LCD monitor Instruction Sheet* (Cat. No. 1636843-6).



Additional Information

The system configuration in this document uses USB for the connection between the Personal computer and PLC. For information on how to install the USB driver, refer to A-5. *Installing the USB Driver* of the *CJ-series CJ2 CPU Unit Hardware User's Manual* (Cat. No. W472).

6. EtherNet/IP Settings

This section describes specifications of parameters and the tag data link allocation that are set in this document.

6.1. Parameters

The parameter settings that are set in this document are as follows:

6.1.1. EtherNet/IP Communications Settings

The parameters required for connecting the PLC and the FH Sensor Controller via EtherNet/IP are given below.

Item	PLC (node 1)	FH Sensor Controller (node 2)
Unit number	0	-
Node address	1	2
IP address	192.168.250.1	192.168.250.2
Subnet mask	255.255.255.0	255.255.255.0
Fieldbus	-	EtherNet/IP
Output control	-	Handshaking (Default)
Timeout [s]	-	10.0 (Default)

*In this document, the gateway setting is unnecessary because the connection is made in the same segment.



Precautions for Correct Use

In order to prevent a phenomenon that a change in the status of each signal cannot be detected by the target device, it is recommended that you set the Output control setting for the FH Sensor Controller to Handshaking. When the Output control of the FH Sensor Controller is set to None, the originator device may not correctly detect a change in the status of a signal from the FH Sensor Controller if RPI is longer than the output time (ON/OFF) on the FH Sensor Controller.

For details, refer to *EtherNet/IP Communications Cycle (RPI)* in *Communicating with EtherNet/IP* in *Section 2. Methods for Connecting and Communicating with External Devices* of the *Vision Sensor FH/FZ5 Series Vision System User's Manual for Communications Settings* (Cat. No. Z342).

6.1.2. Connection Settings

The connection settings of the FH Sensor Controller are shown below.

On the FH Sensor Controller, set the connection type to **Point to Point** for both input and output. Set the Timeout Value so that it is longer than the FH Sensor Controller's measurement processing time. When the measurement interval is short, the measurement processing load is high, or command processing for operations such as scene group changing is time-consuming, the FH Sensor Controller prioritizes measurement and control processing over communication processing. As a result, communication between an external device and the FH Sensor Controller may be temporarily interrupted, and a communication error may occur. In this case, set the communication error timeout time longer than the FH Sensor Controller's processing time.

Connection allocation		Set value
Connection I/O Type		Consume Data From / Produce Data To
Originator Device	Input Tag Set	D10100-[48 Byte]
	Connection Type	Point to Point connection
	Output Tag Set	D10000-[20 Byte]
	Connection Type	Point to Point connection
Target Device	Output Tag Set	Input_101-[48 Byte]
	Input Tag Set	Output_100-[20 Byte]
Packet Interval (RPI)		50.0ms
Timeout Value		Packet interval (RPI) x 4

6.2. Allocating the Tag Data Links

The tag data links allocation of the FH Sensor Controller is as follows:

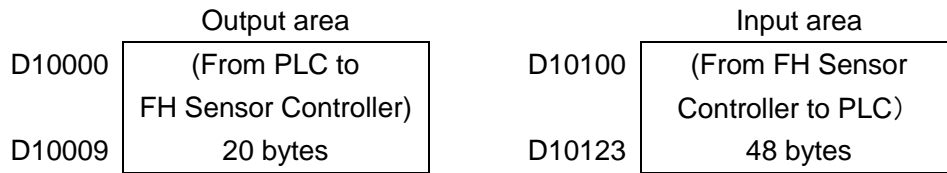

■ Details on output area

Address	Bit															Meaning	
	15	14	13	12	11	10	9	8	7	6	5	4	3	2	1		0
D10000	ERC LR	-	-	-	-	-	-	XEX E	-	-	-	-	-	-	STE P	EXE	Command area
D10001	-	-	-	-	-	-	-	-	-	-	-	-	-	-	-	DSA	Control input (2 words)
D10002	CMD-CODE															Command code (2 words)	
D10003	CMD-CODE															Command code (2 words)	
D10004	CMD-PARAM															Command parameters (6 words max.)	
D10005	CMD-PARAM																
D10006	CMD-PARAM																
D10007	CMD-PARAM																
D10008	CMD-PARAM																
D10009	CMD-PARAM																

EXE: Command Execution Bit: Turns ON to execute a command.

STEP: Measure Bit: Turns ON to execute a measurement.

XEXE: Flow Command Request Bit: Turns ON to request execution of a command during execution of fieldbus flow control.

ERCLR: Error Clear Bit: Turns ON to clear the ERR signal from the FH Sensor Controller.

DSA: Data Output Request Bit: Turns ON to request the next data output.

■ Details on input area

Address	Bit																Meaning
	15	14	13	12	11	10	9	8	7	6	5	4	3	2	1	0	
D10100	ERR	-	-	-	-	XW AIT	XBU SY	XFL G	-	-	-	RUN	OR	-	BUS Y	FLG	Response area
D10101	-	-	-	-	-	-	-	-	-	-	-	-	-	-	-	GATE	Control output (2 words)
D10102	CMD-CODE																Command code (2 words)
D10103	RES-CODE																Response code (2 words)
D10104	RES-CODE																Response code (2 words)
D10105	RES-CODE																Response code (2 words)
D10106	RES-DATA																Response data (2 words)
D10107	RES-DATA																Response data (2 words)
Data output area																	
D10108	DATA 0																Output data 0 (2 words) to Output data 7 (2 words)
D10109	DATA 0																
D10110	DATA 1																
D10111	DATA 1																
D10112	DATA 2																
D10113	DATA 2																
D10114	DATA 3																
D10115	DATA 3																
D10116	DATA 4																
D10117	DATA 4																
D10118	DATA 5																
D10119	DATA 5																
D10120	DATA 6																
D10121	DATA 6																
D10122	DATA 7																
D10123	DATA 7																

FLG: Command Completion Bit: Turns ON when command execution is completed.

BUSY: Command Busy Bit: Turns ON when command execution is in progress.

OR: Overall Judgement: Turns ON when the overall judgement is NG.

RUN: Run Mode: Turns ON while the Sensor Controller is in Run Mode.

XFLG: Flow Command Completion Bit: Turns ON when execution of a command that was input during the execution of fieldbus flow control has been completed (i.e., when XBUSY turns OFF).

XBUSY: Flow Command Busy Bit: Turns ON when execution of a command that was input during execution of fieldbus flow control is in progress.

XWAIT: Flow Command Wait Bit: Turns ON when a command can be input during the execution of fieldbus flow control.

ERR: Error signal: Turns ON when the FH Sensor Controller detects an error signal.

GATE: Data Output Completion Bit: Turns ON when data output is completed.



Additional Information

For details on command codes and response codes, refer to *Command Details for PLC Link, EtherNet/IP, and EtherCAT* under *Command Control* in *Section 3. Appendices* of the *Vision Sensor FH/FZ5 Series Vision System User's Manual for Communications Settings* (Cat. No. Z342).

7. EtherNet/IP Connection Procedure

This section describes the procedure for connecting the FH Sensor Controller to the PLC via EtherNet/IP.

This document explains the procedures for setting up the PLC and the FH Sensor Controller based on the factory default setting. For the initialization, refer to *Section 8. Initialization Method*.

7.1. Work Flow

Take the following steps to set the tag data link for EtherNet/IP.

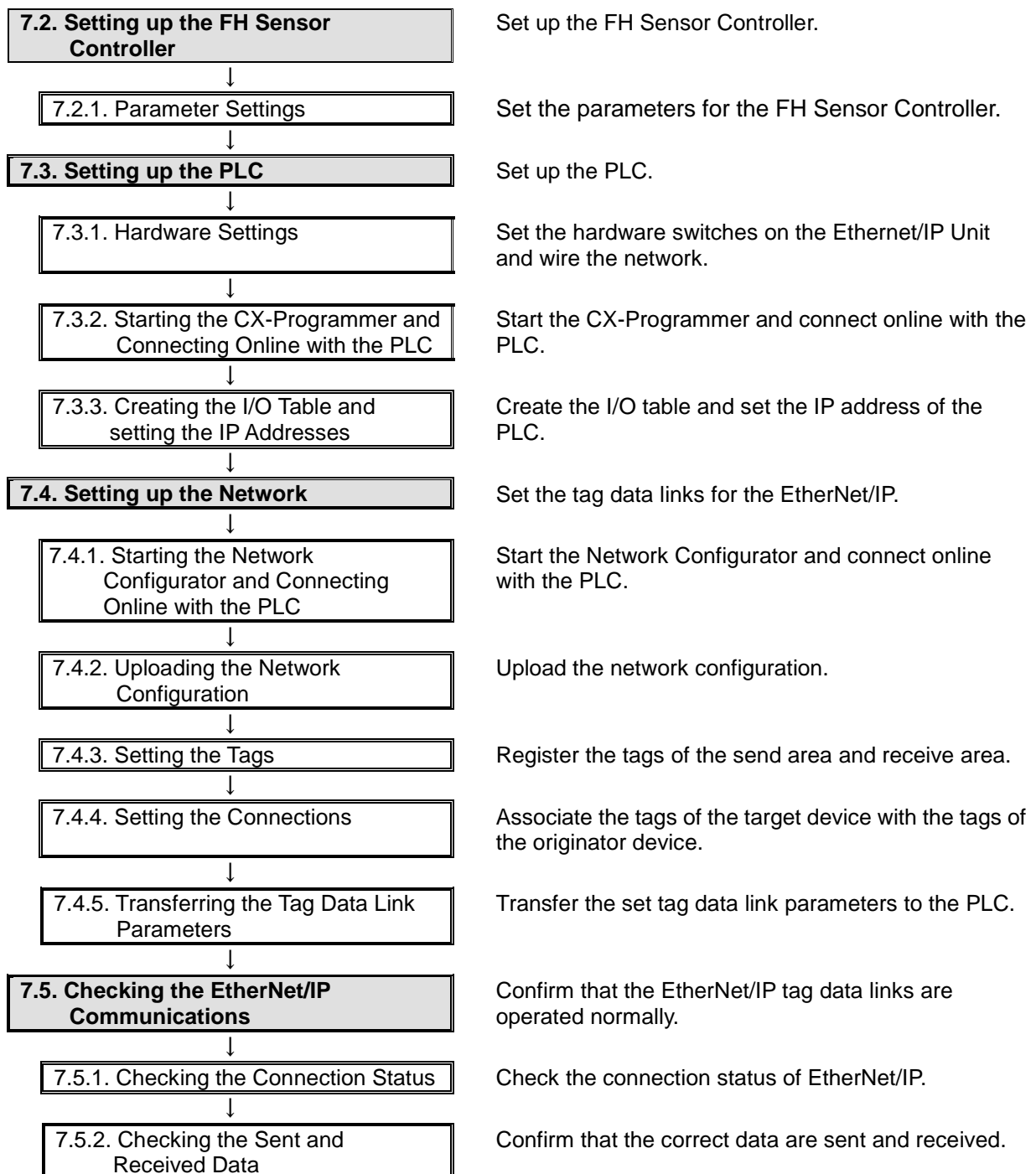

7.2. Setting up the FH Sensor Controller

Set up the FH Sensor Controller.

7.2.1. Parameter Settings

Set the parameters for the FH Sensor Controller.

- 1 Check the positions of the connectors on the FH Sensor Controller by referring to the right figure.

*In the Ethernet connectors, only the PORT2 (lower port) can be used for EtherNet/IP communications. The PORT1 (upper port) and the EtherCAT communication connector (IN and OUT) cannot be used for the EtherNet/IP.

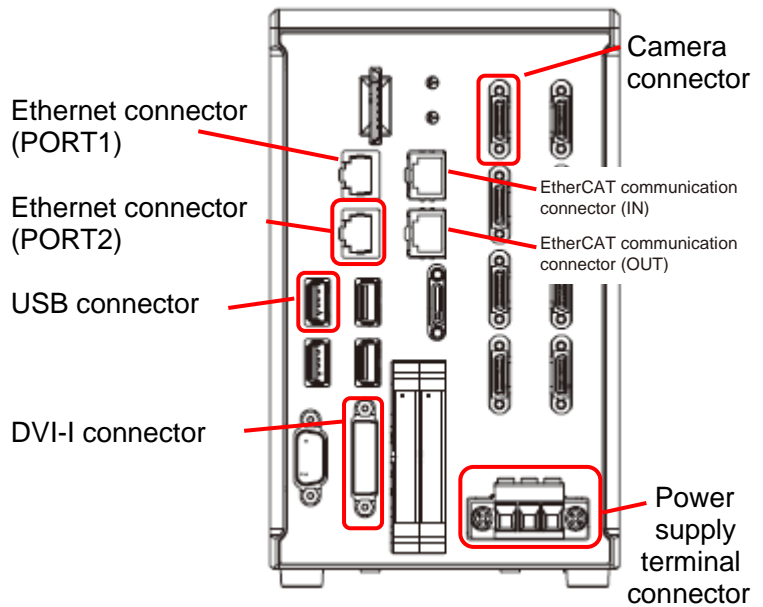

- 2 As shown in *Section 5.2. Device Configuration*, connect the Camera, Monitor, USB mouse, and 24 VDC power supply (For FH Sensor Controller) to the FH Sensor Controller. Connect LAN cable to PORT2 (lower port) of the Ethernet connector. Connect the 24 VDC power supply (For Monitor) to the Monitor.

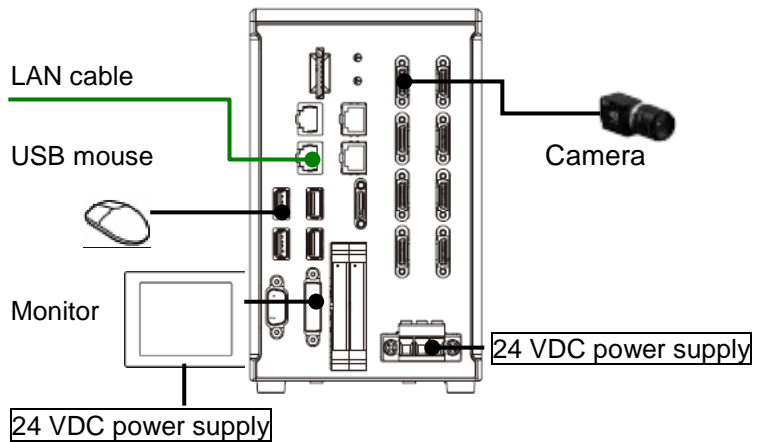

- 3 Connect the FH Sensor Controller to the Switching hub with the LAN cable. Connect the 24 VDC power supply (For Switching hub) to the Switching hub.

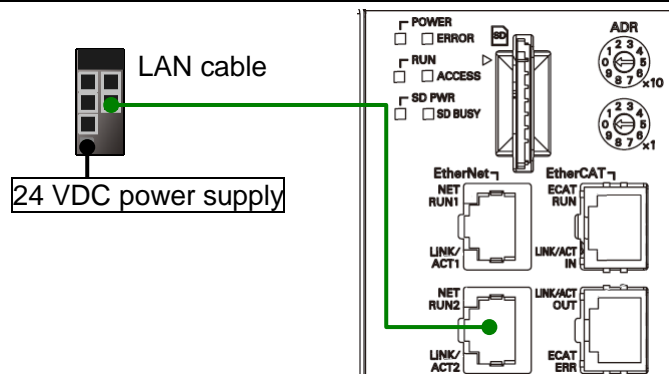

- 4 Turn ON the power supply to the FH Sensor Controller and the Monitor.

5 The Language setting Dialog Box is displayed on the Monitor connected to the FH Sensor Controller only at the initial start. Select **English** from the pull-down list.

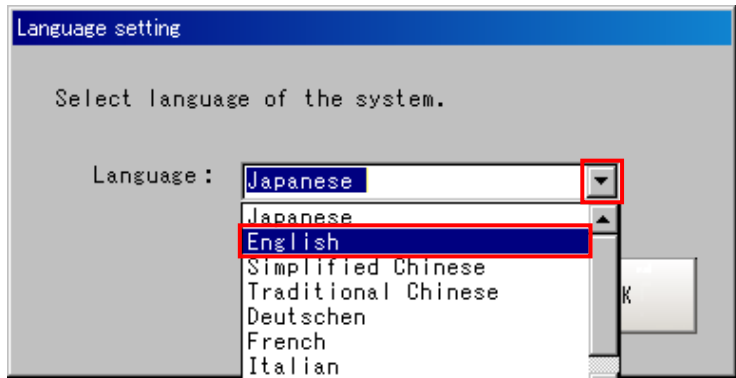

Check that the English is selected in the *Language* Field and click the **OK** Button.

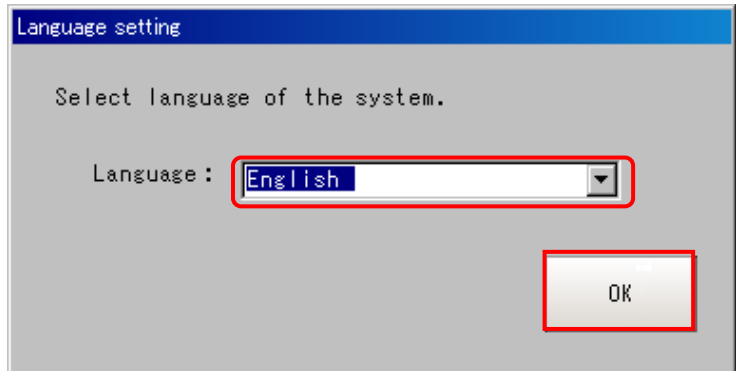

Confirm that your desired Language is selected and click the **Yes** Button.

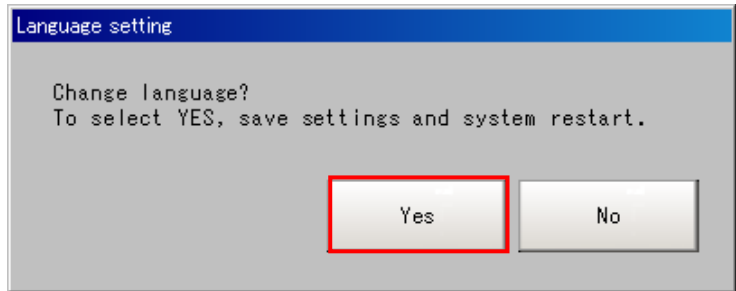

6 Select **System Settings** from the Tool Menu on the FZ-PanDA Dialog Box that is shown on the Monitor connected to the FH Sensor Controller.



7 Select **System Settings – Startup - Startup setting** from the tree.

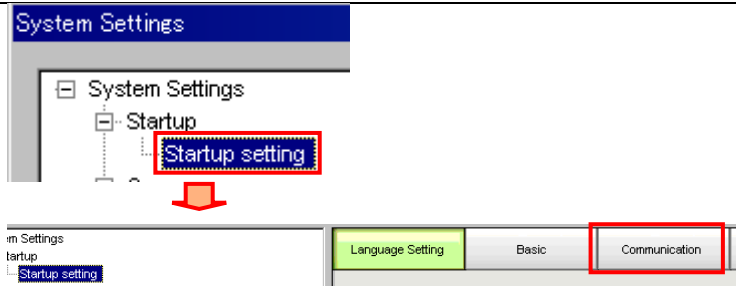

Select the **Communication** Tab in the right figure.

8 The *Communication module select* Field is displayed. Select **EtherNet/IP** from the *Fieldbus* pull-down list.

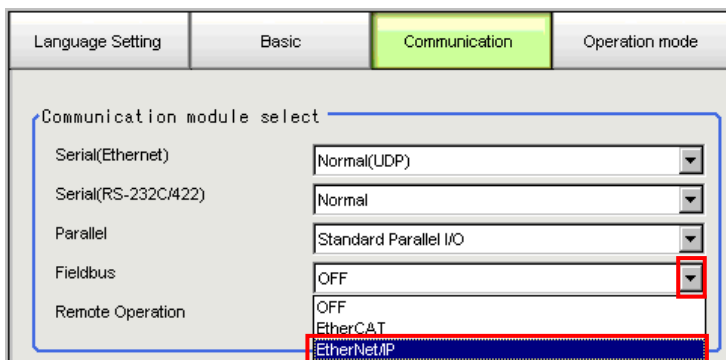

Check that the EtherNet/IP is selected in the *Fieldbus* Field.

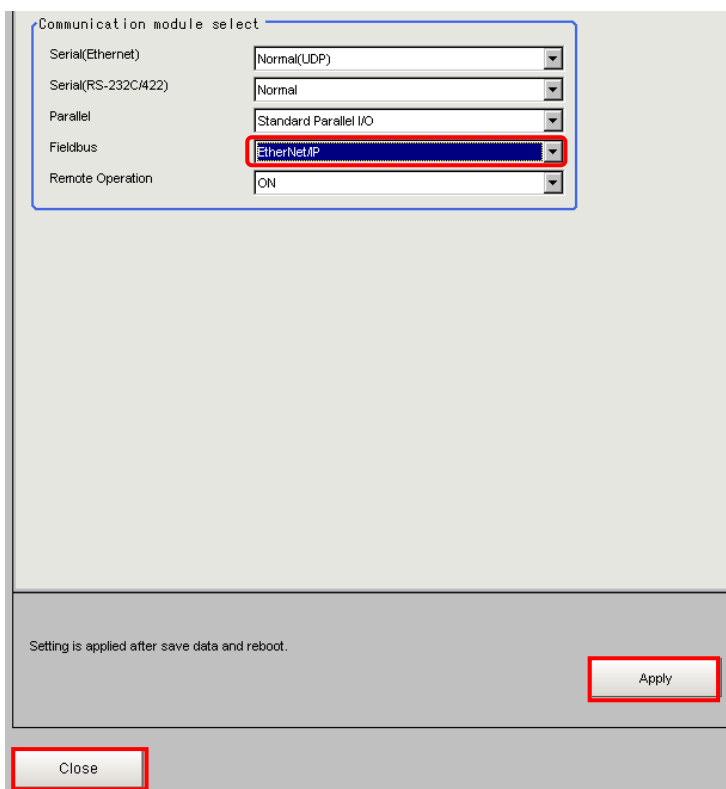



Click the **Apply** Button.
Click the **Close** Button to close the System Settings Window.

* After the data set in the System Settings Window are saved and then the FH Sensor Controller is restarted as shown on the right, the settings become enabled.

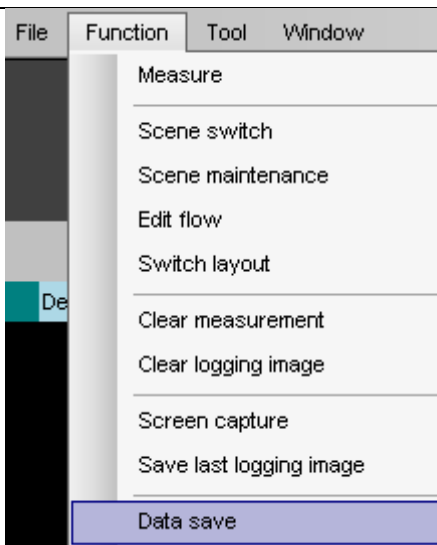
9 Select **Data save** from the Function Menu.

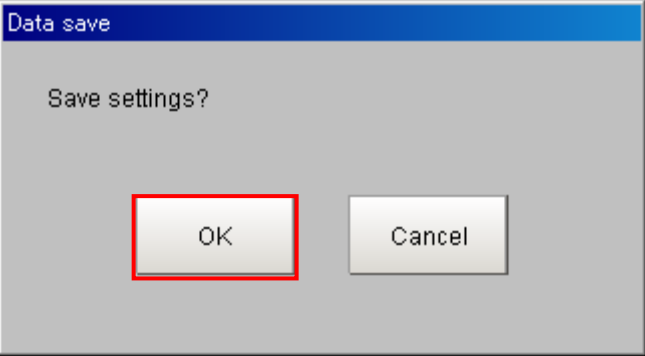
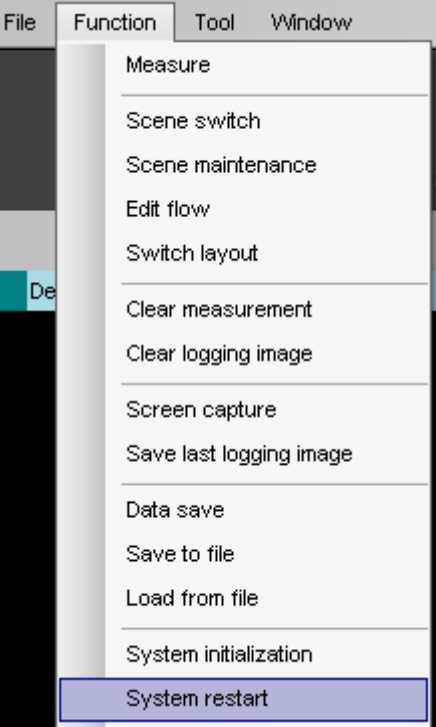
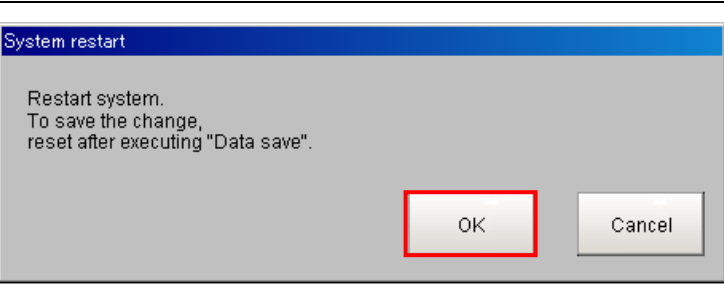

<p>10</p>	<p>The Data save Dialog Box is displayed. Check the contents and click the OK Button.</p>	
<p>11</p>	<p>Select System restart from the Function Menu.</p>	
<p>12</p>	<p>The System restart Dialog Box is displayed. Check the contents and click the OK Button.</p>	
<p>13</p>	<p>After restarting, select System Settings from the Tool Menu.</p>	

14 Select **System Settings - Communication - Ethernet(Normal(UDP))** from the tree.

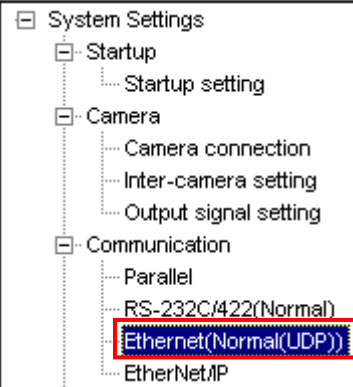



15 The dialog box on the right is displayed. Select the *Use the following IP address* Option for the *Address setting 2* Field and enter the following values.

- IP address: 192.168.250.2
- Subnet mask: 255.255.255.0

*Even if you use the FH Sensor Controller with only one Ethernet port as typified by FH-1050 etc., always set the *Address setting 2* Field.

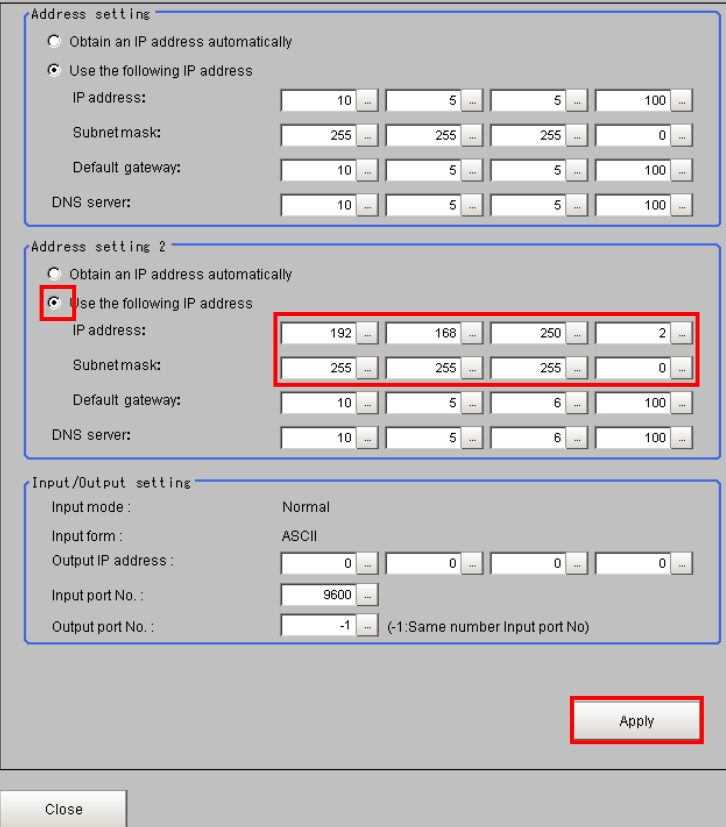
After setting, click the **Apply** Button.



* To change a value, click the  Button which is in the right of each octet of IP address. The numeric keyboard is displayed. Enter values using the mouse. After entering the values, click the **OK** Button on the numeric keyboard.

*How to change values



- 16 Select **System Settings - Communication - Ethernet/IP** from the tree.

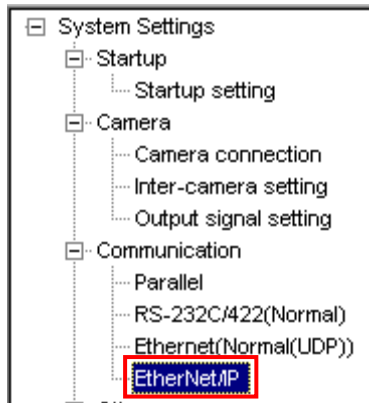

- 17 The Setting Tab is displayed. Check the following values.
- Output control: *Handshaking*
 - Timeout [s]: *10.0*

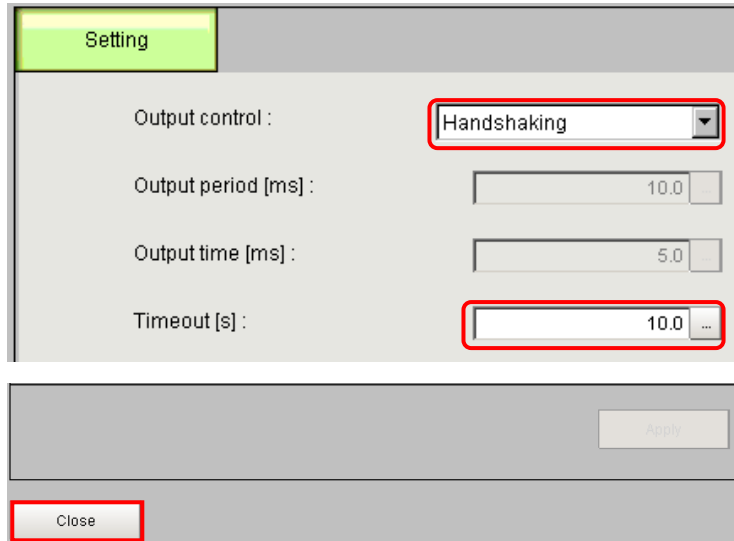

Click the **Close** Button to close the System Settings Window.

- 18 In the same way as steps 9 and 10, select **Data save** from the Function Menu.

- 19 In the same way as steps 11 and 12, select **System restart** from the Function Menu.

7.3. Setting up the PLC

Set up the PLC.

7.3.1. Hardware Settings

Set the hardware switches on the Ethernet/IP Unit and wire the network.



Precautions for Correct Use

Make sure that the power supply is OFF when you perform the setting up.

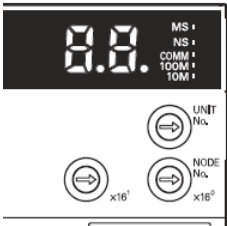
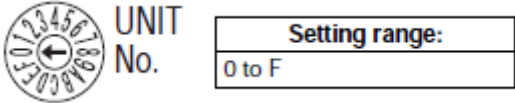
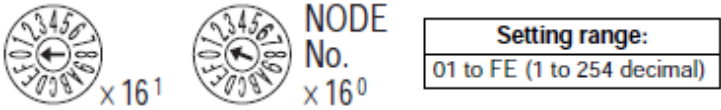
<p>1 Make sure that the power supply to the PLC and the Switching hub is OFF.</p> <p>*If the power supply is turned ON, settings may not be applicable as described in the following procedure.</p>			
<p>2 Check the positions of the hardware switches on the front of the EtherNet/IP Unit by referring to the right figure.</p>	 <p>LED Indicators</p> <p>Unit number setting switch</p> <p>Node address setting switches</p>		
<p>3 Set the Unit number setting switch to 0.</p>	<p>The unit number is used to identify individual CPU Bus Units when more than one CPU Bus Unit is mounted to the same PLC. Use a small screwdriver to make the setting, taking care not to damage the rotary switch. The unit number is factory-set to 0.</p>  <table border="1" style="margin-left: auto; margin-right: auto;"> <tr> <td style="text-align: center;">Setting range:</td> </tr> <tr> <td style="text-align: center;">0 to F</td> </tr> </table>	Setting range:	0 to F
Setting range:			
0 to F			
<p>4 Set the Node address setting switches to the following default settings.</p> <p>NODE No.x16¹: 0</p> <p>NODE No.x16⁰: 1</p> <p>*Set the IP address to 192.168.250.1.</p> <p>*By default, the first to third octets of the local IP address are fixed to 192.168.250. The fourth octet is the values that are set with the Node address setting switches.</p>	<p>With the FINS communications service, when there are multiple EtherNet/IP Units connected to the Ethernet network, the EtherNet/IP Units are identified by node addresses. Use the node address switches to set the node address between 01 and FE hexadecimal (1 to 254 decimal). Do not set a number that has already been set for another node on the same network.</p>  <table border="1" style="margin-left: auto; margin-right: auto;"> <tr> <td style="text-align: center;">Setting range:</td> </tr> <tr> <td style="text-align: center;">01 to FE (1 to 254 decimal)</td> </tr> </table> <p>The left switch sets the sixteens digit (most significant digit) and the right switch sets the ones digit (least significant digit). The node address is factory-set to 01.</p>	Setting range:	01 to FE (1 to 254 decimal)
Setting range:			
01 to FE (1 to 254 decimal)			

- 5 Connect the LAN cable to the EtherNet/IP port of the PLC, and connect the USB cable to the USB port. Connect the personal computer, Switching Hub, and PLC as shown in 5.2. *Device Configuration*.

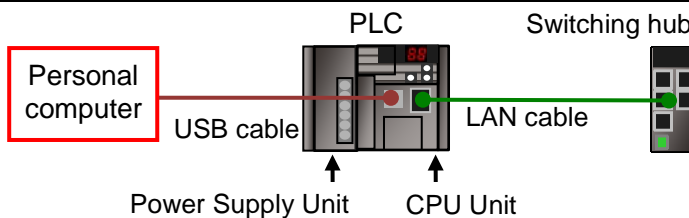

- 6 Turn ON the power supply to the PLC and Switching hub.



- 7 The set IP address is displayed on the seven-segment LED indicators. Afterwards, the last digit of the IP address is displayed in hexadecimal during normal operation.

7.3.2. Starting the CX-Programmer and Connecting Online with the PLC

Start the CX-Programmer and connect online with the PLC.

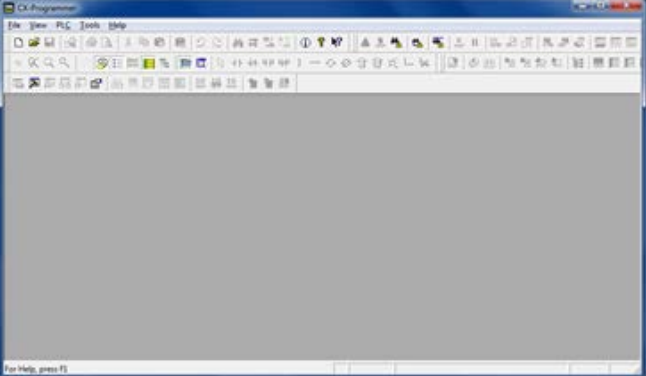
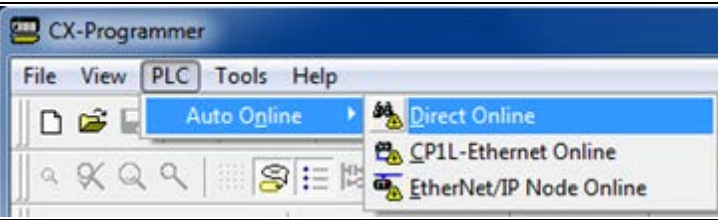
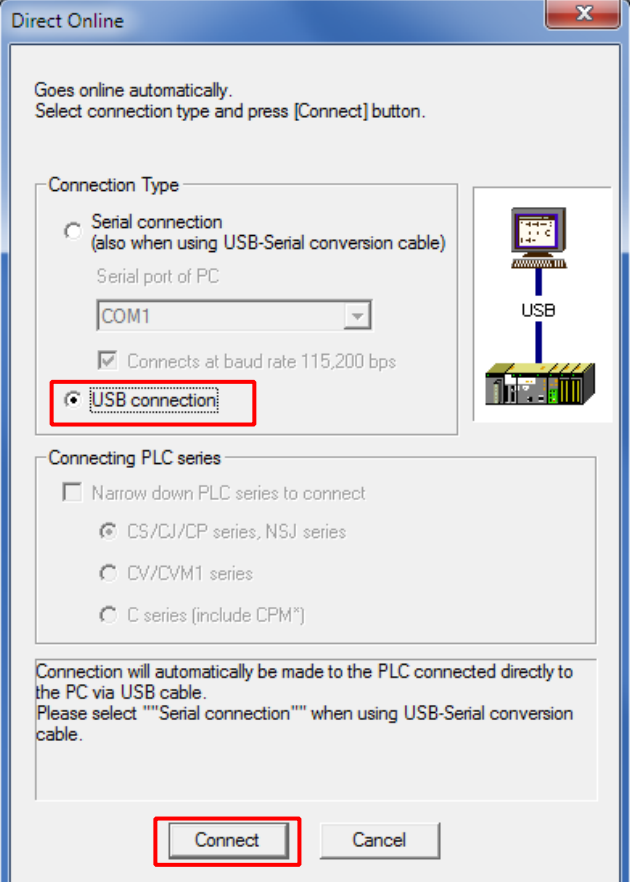
Install the CX-One and USB driver in the Personal computer beforehand.

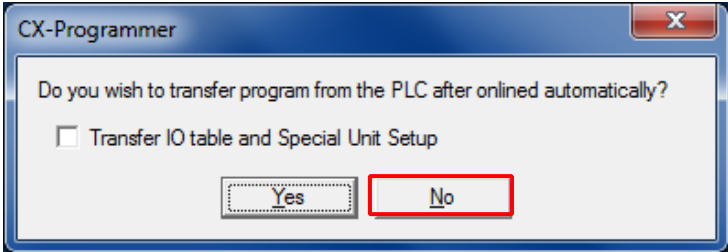
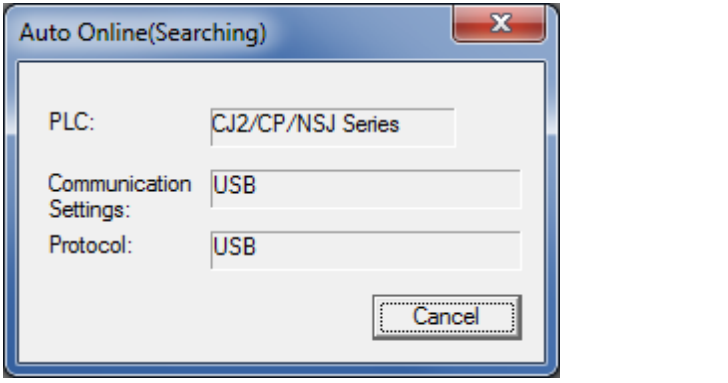
<p>1 Start the CX-Programmer.</p> <p>*If a confirmation dialog for an access right is displayed at start, execute a selection to start.</p>	
<p>2 The CX-Programmer starts.</p>	
<p>3 Select Auto Online - Direct Online from the PLC Menu.</p>	
<p>4 The Direct Online Dialog Box is displayed. Select the USB connection Option for Connection Type. Click the Connect Button.</p>	

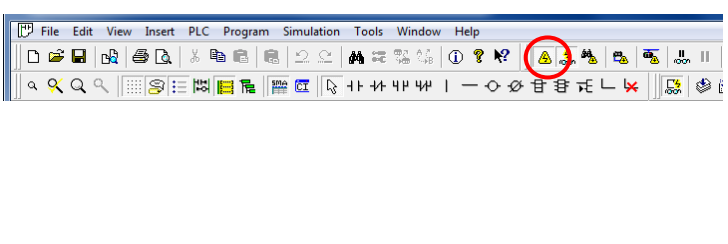
<p>5 The dialog box on the right is displayed. Check the contents and click the No Button.</p>	
<p>6 The dialog box on the right is displayed, and the CX-Programmer and the PLC are automatically connected.</p>	
<p>7 Confirm that the CX-Programmer and the PLC are normally connected online.</p> <p>*The  icon is pressed down during online connection.</p>	



Additional Information

If an online connection cannot be made to the PLC, check the cable connection.

Or, return to step 1, check the settings and repeat each step.

For details, refer to *Connecting Directly to a CJ2 CPU Unit Using a USB Cable* in *Chapter 3 Communications in PART 3: CX-Server Runtime* of the *CX-Programmer Operation Manual* (Cat. No. W446).



Additional Information

The dialog boxes explained in the following procedures may not be displayed depending on the environmental setting of CX-Programmer.

For details on the environmental setting, refer to *Options and Preferences* in *Chapter 3 Project Reference in PART 1: CX-Programmer* of the *CX-Programmer Operation Manual* (Cat. No. W446). This document explains the setting procedure when the Confirm all operations affecting the PLC Check Box is selected.

7.3.3. Creating the I/O Table and setting the IP Addresses

Create the I/O table and set the IP address of the PLC.

1 If the operating mode of the PLC is Run Mode or Monitor Mode, change it to Program Mode by following the steps below.

(1) Select **Operating Mode - Program** from the PLC Menu of the CX-Programmer.

(2) The dialog box on the right is displayed. Confirm that there is no problem and click the **Yes** Button.

*Refer to Additional Information on the previous page for the settings concerning the dialog display.

(3) Confirm that Stop/Program Mode is displayed on the right of the PLC model in the project workspace of the CX-Programmer.

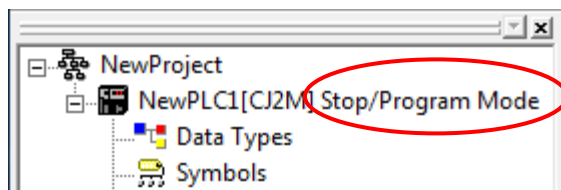
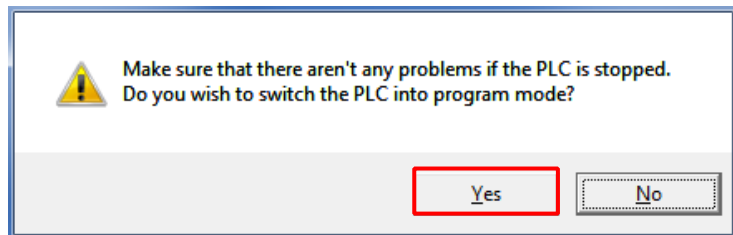
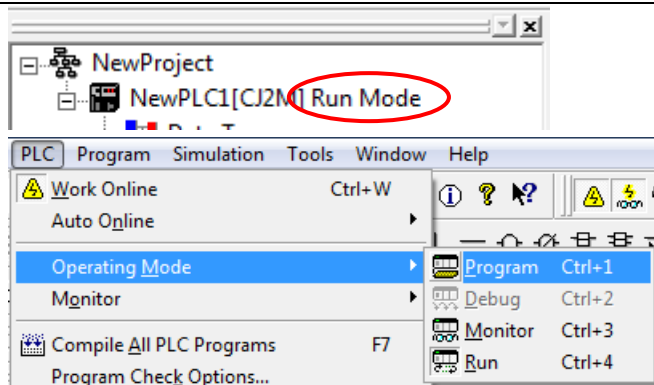

(Project workspace)

2 Select **Edit - I/O Table and Unit Setup** from the PLC Menu of the CX-Programmer.

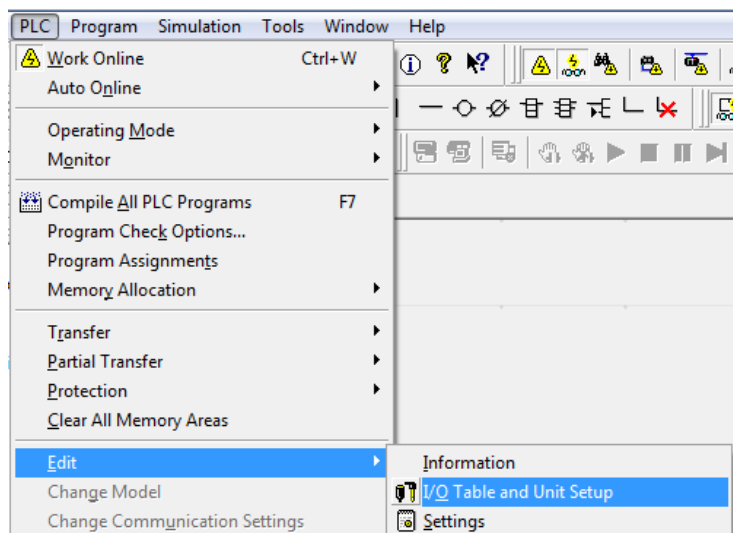

The PLC IO Table Window is displayed.

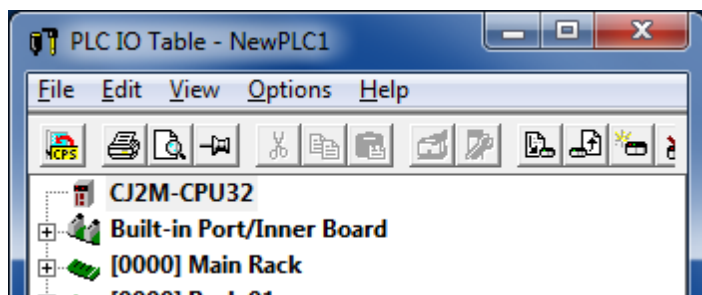



Precautions for Correct Use

The PLC will be reset after creating and transferring the I/O table in step 3 and subsequent steps. Always confirm safety before creating and transferring the I/O table.

- 3 Select **Create** from the Options Menu of the PLC IO Table Window.

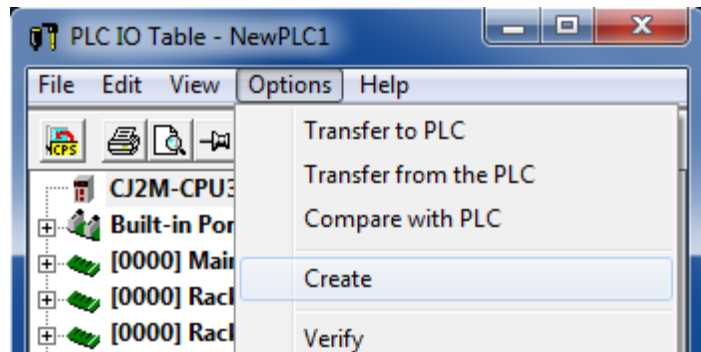

The dialog box on the right is displayed. Confirm that there is no problem and click the **Yes** Button.

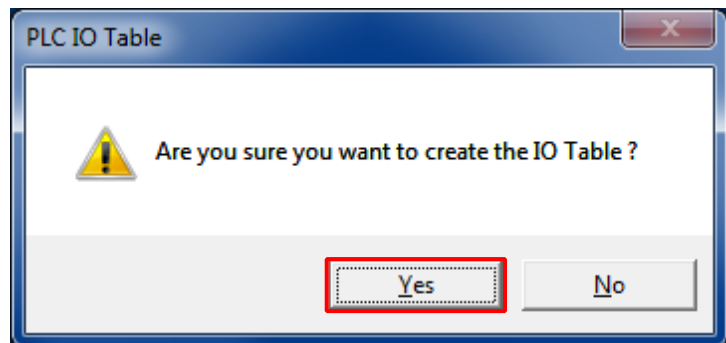

The dialog box on the right is displayed. Confirm that there is no problem and click the **Yes** Button.

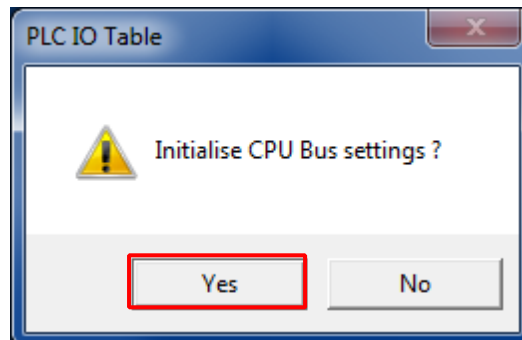

- 4 The Transfer from PLC Dialog Box is displayed. Select the *I/O Table* Check Box and the *SIO Unit Parameters* Check Box, and click the **Transfer** Button.

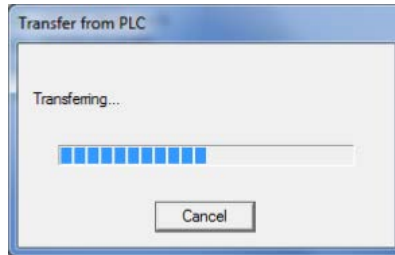
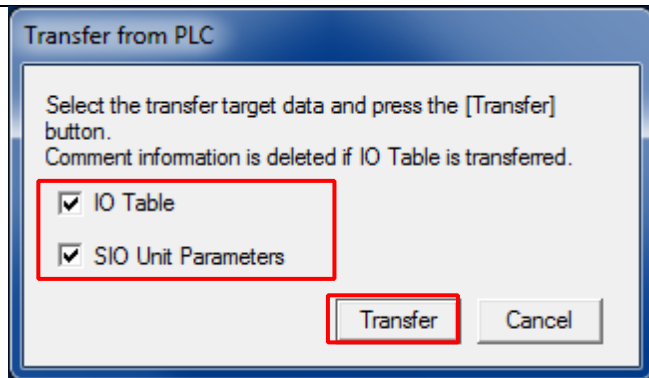

When the transfer is completed, the Transfer Results Dialog Box is displayed.

Confirm that the transfer was normally executed by referring to the message in the dialog box.

When the I/O table is created normally, the dialog box displays as follows:

Transfer Success: 1 Unit
Transfer Unsuccessful: 0 Unit

Click the **OK** Button.

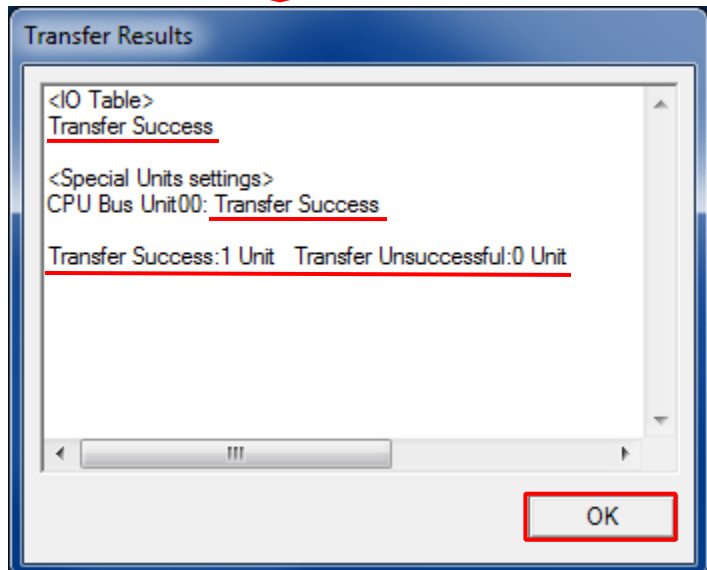

- 5 On the PLC IO Table Window, click + to the left of Built-in Port/Inner Board to display CJ2M-EIP21.

*The right figure displays the CPU Unit (Built-in EtherNet/IP port) specified in 5.2. *Device Configuration*. If you use other applicable EtherNet/IP Units, the display position and name are different from this figure.

Right-click **CJ2M-EIP21** and select **Unit Setup**.

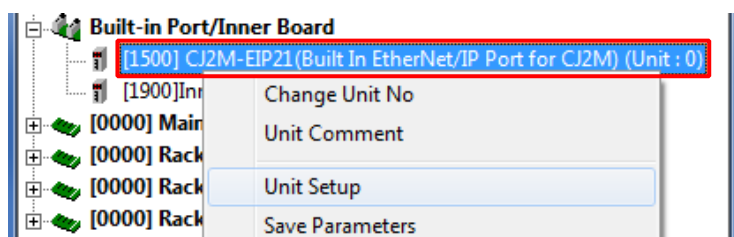
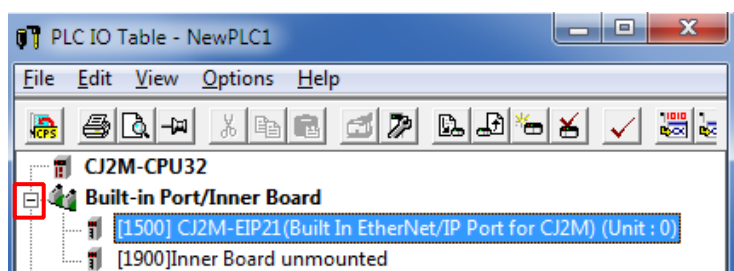

6 The Edit Parameters Dialog Box is displayed. Select the **TCP/IP** Tab.

Make the following settings in the *IP Address* Field.

- Use the following address:
Select
- IP Address: 192.168.250.1
- Sub-net Mask: 255.255.255.0

Click the **Transfer[PC to Unit]** Button.

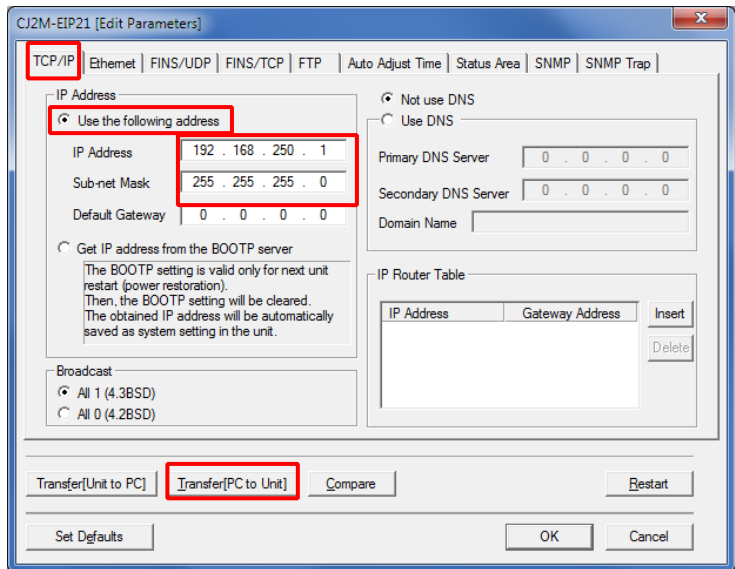

7 The dialog box on the right is displayed. Confirm that there is no problem and click the **Yes** Button.

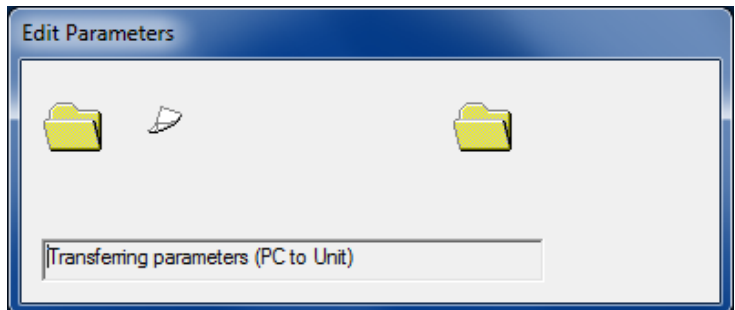
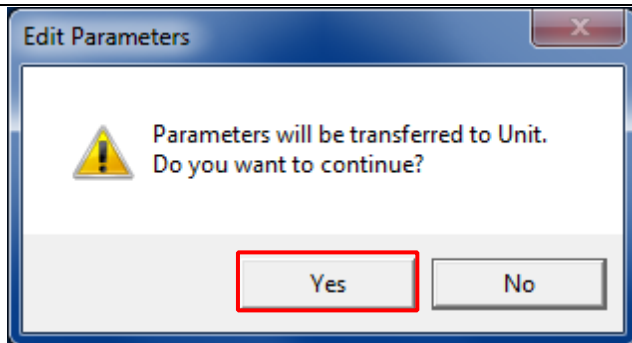

Confirm that a message stating "Transfer successful" is displayed, and click the **Close** Button.

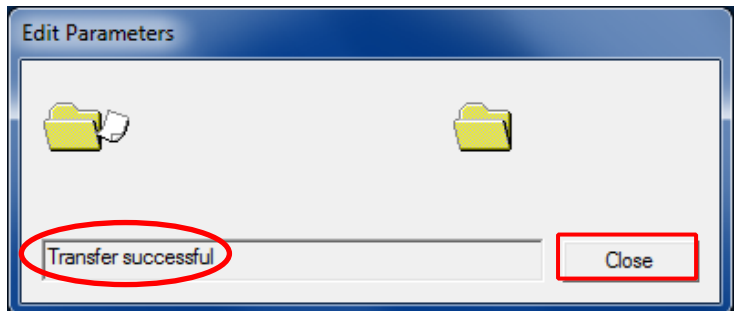

- 8 A confirmation dialog box is displayed. Check the contents and click the **Yes** Button.

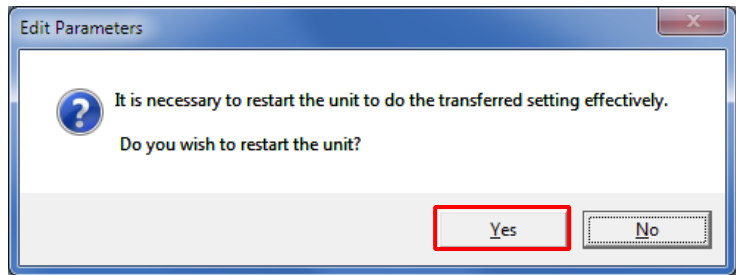

When the Unit is restarted, the dialog box on the right is displayed. Check the contents and click the **OK** Button.

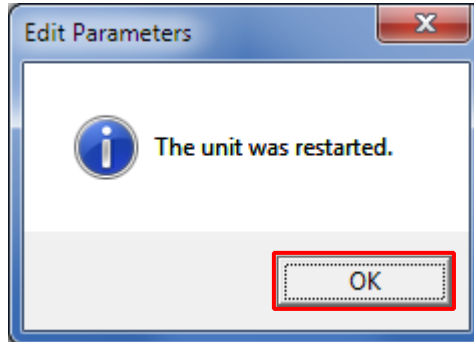

- 9 Click the **Compare** Button to confirm that the IP address is correctly changed.

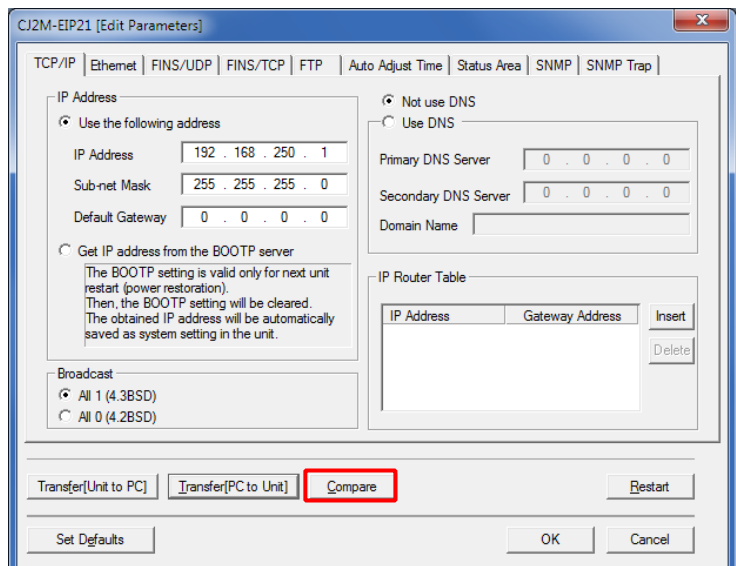

- 10 Confirm that a message stating "Compare successful" is displayed, and click the **Close** Button.

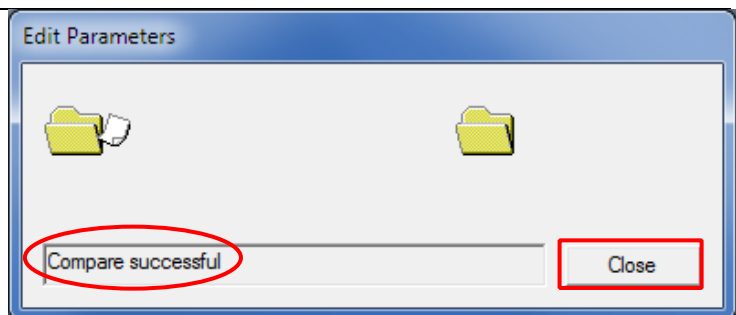

- 11 Click the **OK** Button on the Edit Parameters Dialog Box.



7.4. Setting up the Network

Set the tag data links for the EtherNet/IP.

7.4.1. Starting the Network Configurator and Connecting Online with the PLC

Start the Network Configurator and connect online with the PLC.

- 1 Right-click **CJ2M-EIP21** on the PLC IO Table Window and select **Start Special Application - Start with Settings Inherited**.

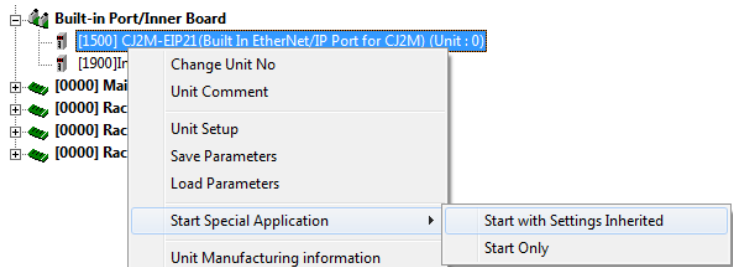

The Select Special Application Dialog Box is displayed. Select *Network Configurator* and click the **OK** Button.

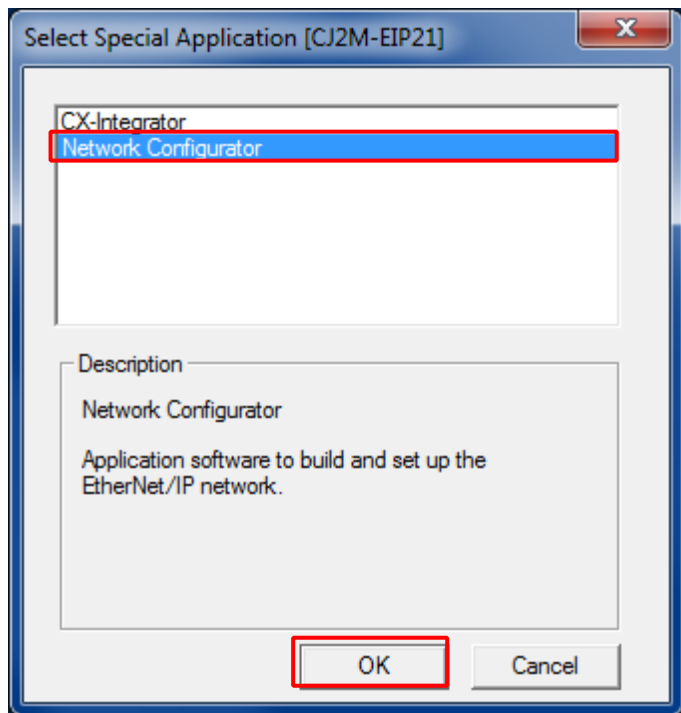

- 2 Network Configurator is started. The following panes are displayed in this window.
Left: Hardware List
Right: Network Configuration Pane

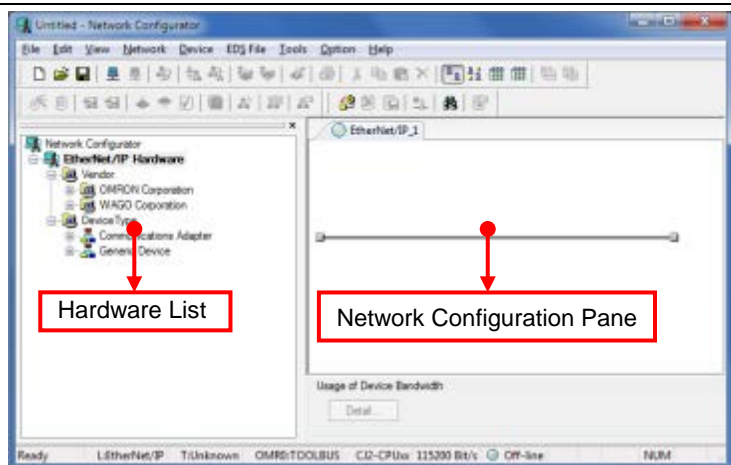



Precautions for Correct Use

Confirm that the LAN cable is connected before taking the following procedure.

When it is not connected, turn OFF the power supply to each device and then connect the LAN cable.

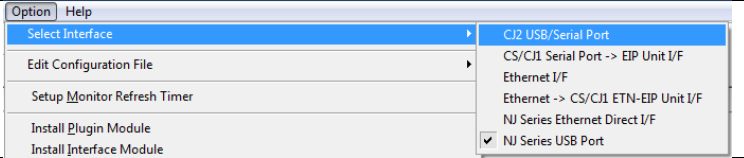
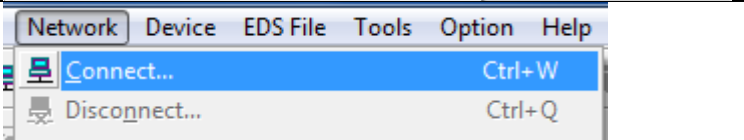
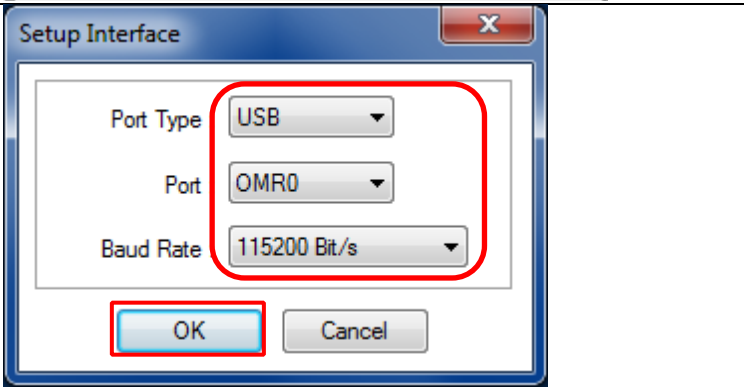
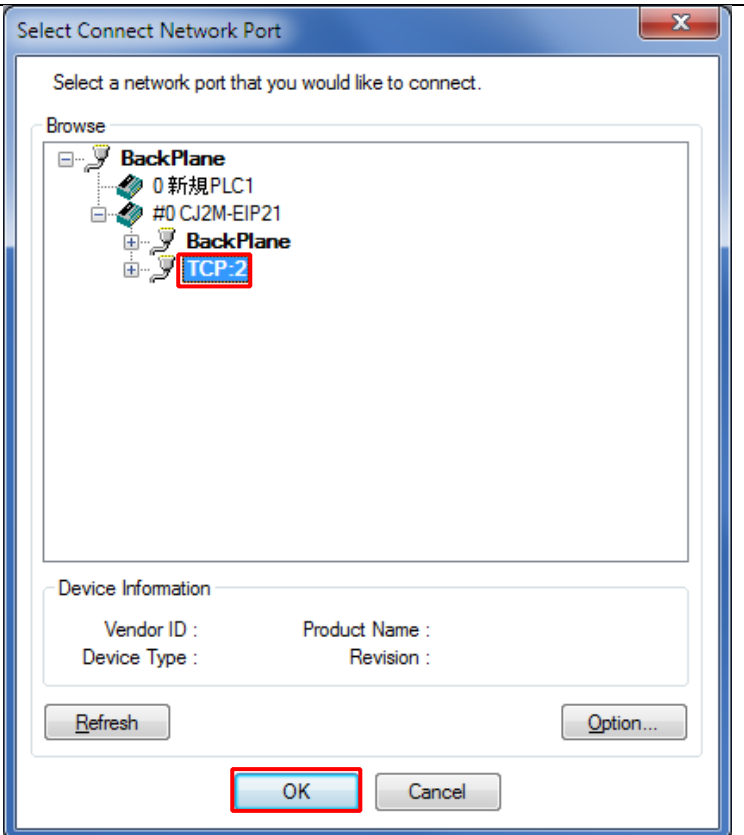
<p>3 Select Select Interface - CJ2 USB/Serial Port from the Option Menu.</p>	
<p>4 Select Connect from the Network Menu.</p>	
<p>5 The Setup Interface Dialog Box is displayed. Confirm that the following settings are made. Port Type: USB Port: OMR0 Baud Rate: 115200 Bit/s</p> <p>Click the OK Button.</p>	
<p>6 The Select Connect Network Port Dialog Box is displayed. Select Back Plane - CJ2M-EIP21 - TCP:2.</p> <p>Click the OK Button.</p>	

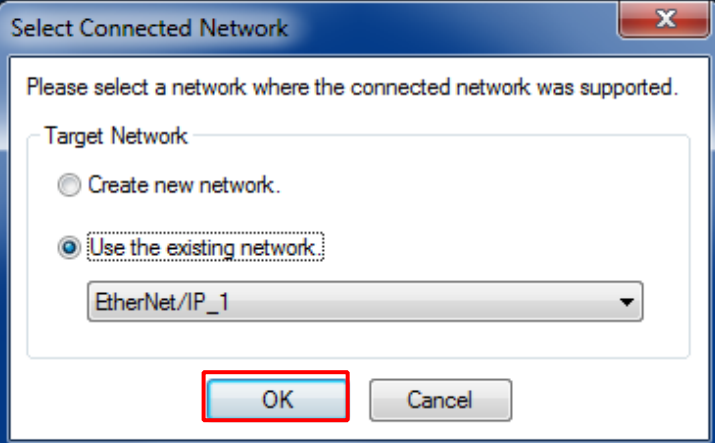
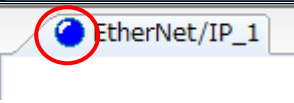
<p>7 The Select Connected Network Dialog Box is displayed. Check the contents and click the OK Button.</p>	
<p>8 When an online connection is established normally, the color of the icon on the figure changes to blue.</p>	



Additional Information

If an online connection cannot be made to the PLC, check the cable connection.

Or, return to step 3, check the settings and repeat each step.

For details, refer to 6-2-9 *Connecting the Network Configurator to the Network* in Section 6. *Tag Data Link Functions of the EtherNet/IP™ Units Operation Manual* (Cat. No. W465).

7.4.2. Uploading the Network Configuration

Upload the network configuration.

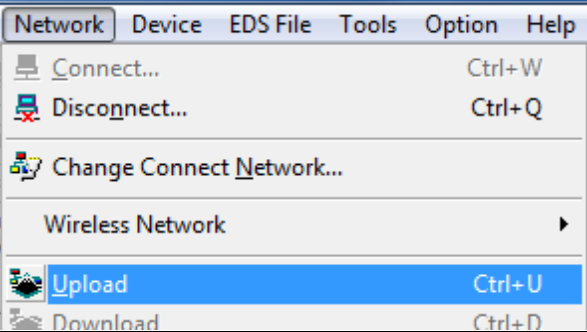
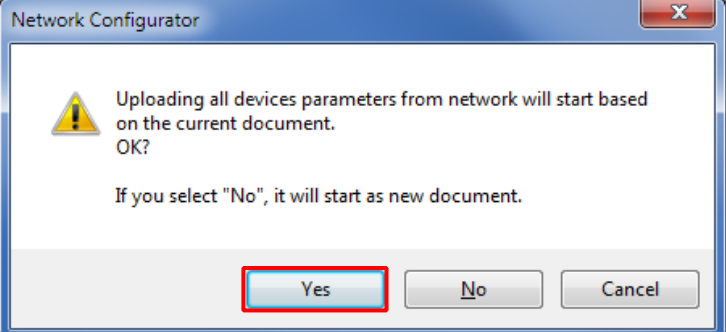
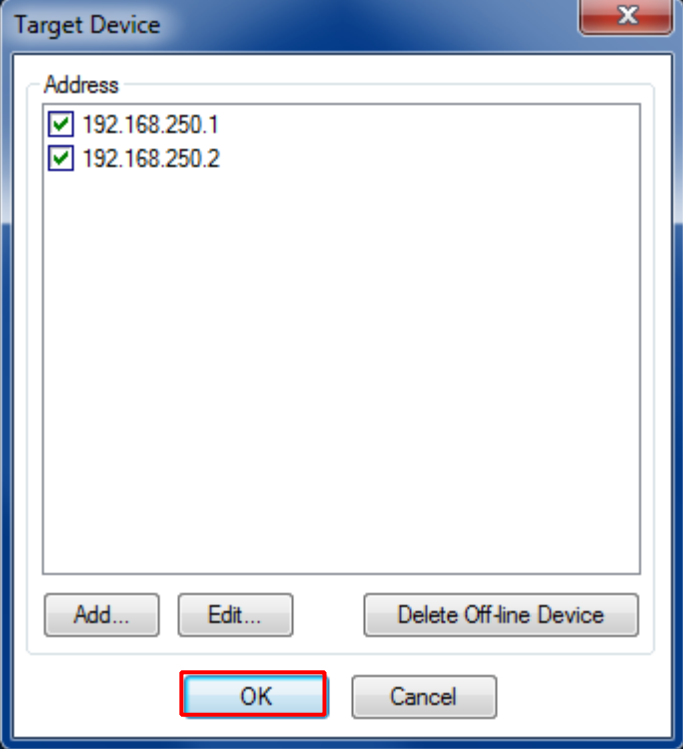
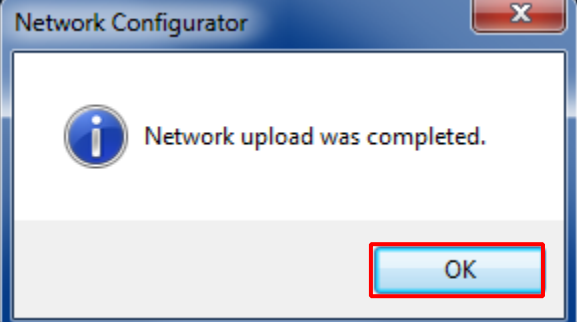
<p>1 Select Upload from the Network Menu to upload the device information on the network.</p>	
<p>2 The dialog box on the right is displayed. Confirm that there is no problem and click the Yes Button.</p>	
<p>3 The Target Device Dialog Box is displayed. Select the <i>192.168.250.1</i> Check Box and the <i>192.168.250.2</i> Check Box.</p> <p>Click the OK Button.</p> <p>*If 192.168.250.1 and 192.168.250.2 are not displayed on the dialog box, click the Add Button to add the addresses.</p> <p>*The displayed addresses depend on the status of the Network Configurator.</p>	
<p>4 The device parameters are uploaded. When uploading is completed, the dialog box on the right is displayed. Check the contents and click the OK Button.</p>	

- 5 After uploading, confirm that the IP addresses of uploaded nodes are updated on the Network Configuration Pane as follows.

IP address of node 1:

192.168.250.1

IP address of node 2:

192.168.250.2

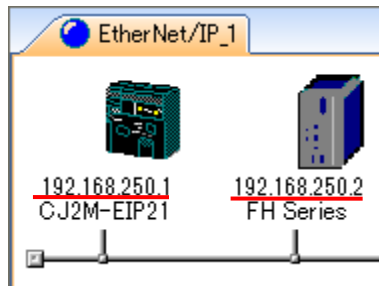

*The FH Sensor Controller Icon is displayed as the FH Series device.

- 6 Right-click the node 2 device and select **Parameter - Edit**.

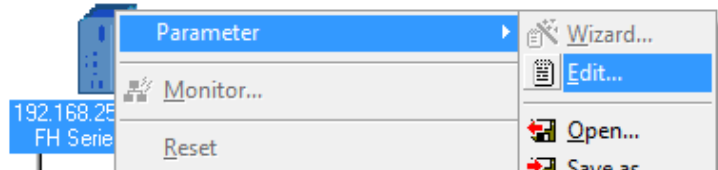

- 7 The Edit Device Parameters Dialog Box is displayed. Check that the following values are set, and click the **OK** Button.

Input Size : 48

Output Size : 20

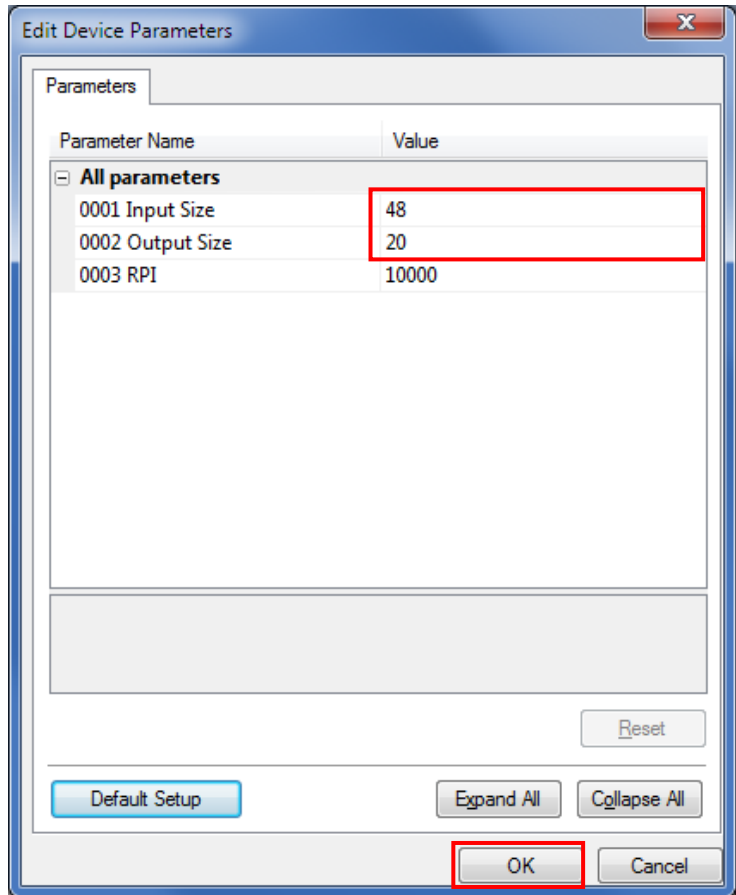

7.4.3. Setting the Tags

Register the tags of the send area and receive area.

This section explains the receive settings and send settings of the target device in order.

<p>1 On the Network Configuration Pane of the Network Configurator, right-click the node 1 device and select Parameter - Edit.</p>	
<p>2 The Edit Device Parameters Dialog Box is displayed. Select the Tag Sets Tab.</p>	
<p>3 The data on the Tag Sets Tab is displayed. Select the In-Consume Tab and click the Edit Tags Button.</p>	

- 4 The Edit Tags Dialog Box is displayed. Select the **In - Consume** Tab and click the **New** Button.
Here, register an area where node 1 receives data from node 2.

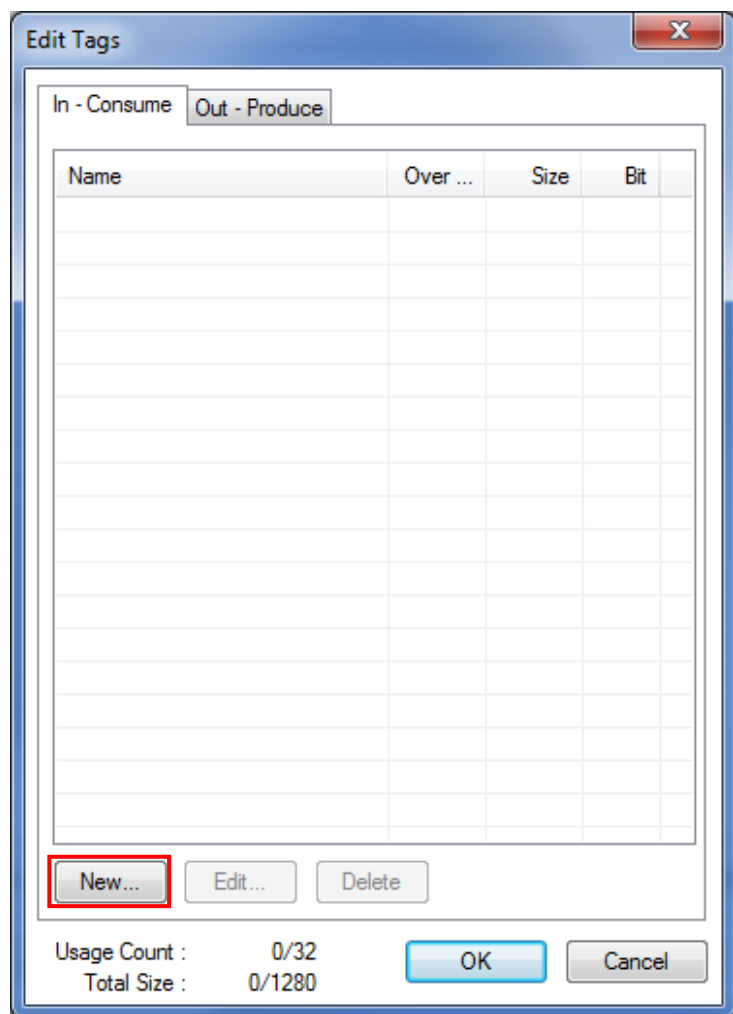

- 5 The Edit Tag Dialog Box is displayed. Enter the following values in the parameters.
Name: *D10100* (Start address of the input data to node 1)
Size: 48 (bytes)

After entering, click the **Regist** Button.

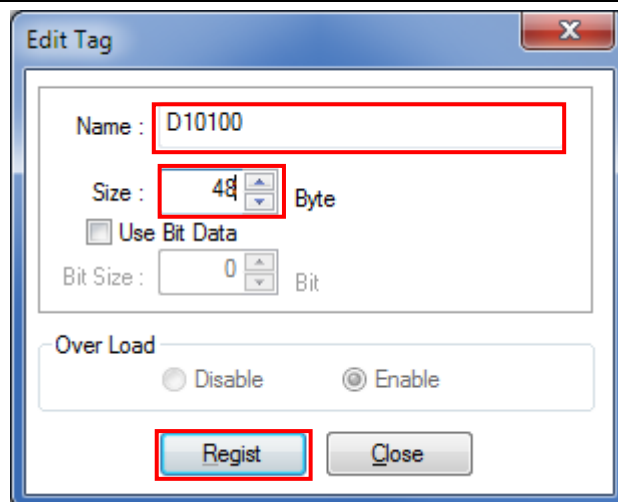

- 6 The Edit Tag Dialog Box is displayed again. Click the **Close** Button.



- 7 Click the **Out - Produce** Tab, and then click the **New** Button. Here, register the data sent from node 1 to node 2.

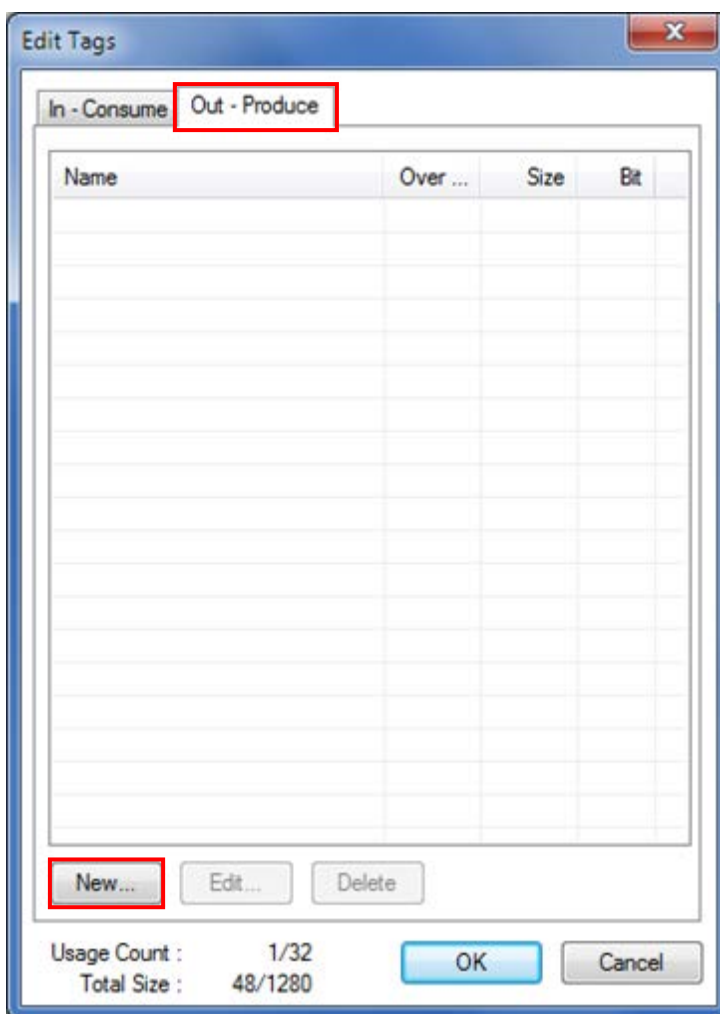

- 8 The Edit Tag Dialog Box is displayed. Enter the following values in the parameters.

Name: *D10000* (Start address of the output data from node 1)

Size: 20 (bytes)

After entering, click the **Regist** Button.

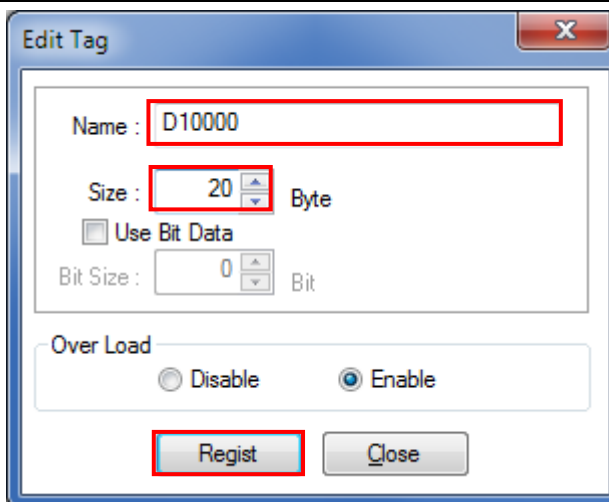

- 9 The Edit Tag Dialog Box is displayed again. Click the **Close** Button.



- 10 When you finish the registration, click the **OK** Button on the Edit Tags Dialog Box.

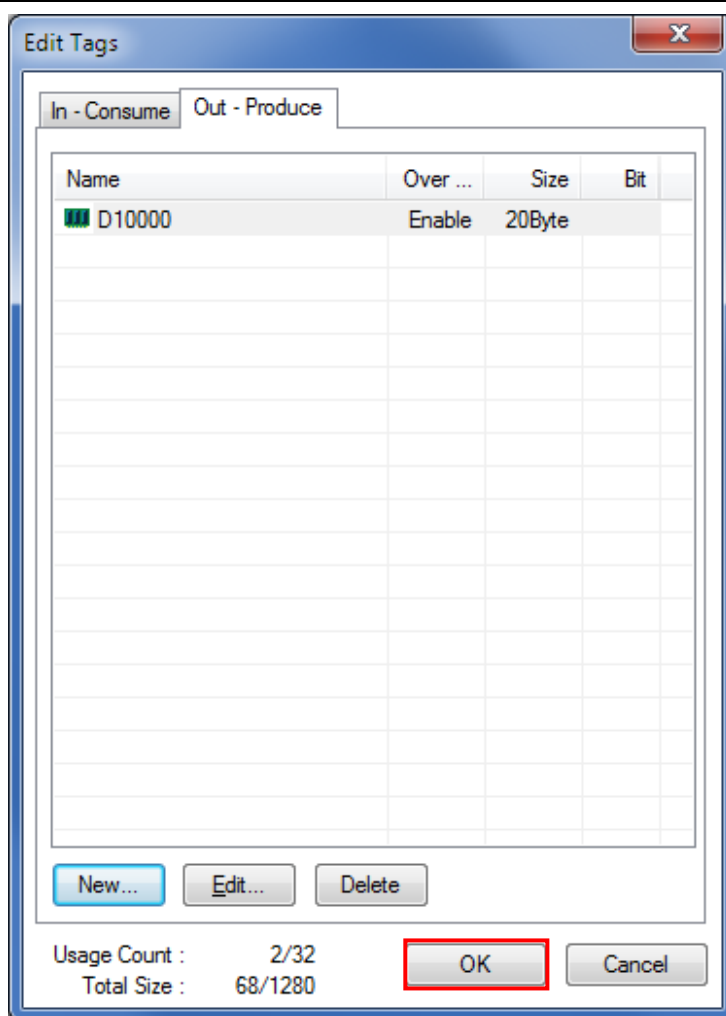

- 11 The dialog box on the right is displayed. Confirm that there is no problem and click the **Yes** Button.

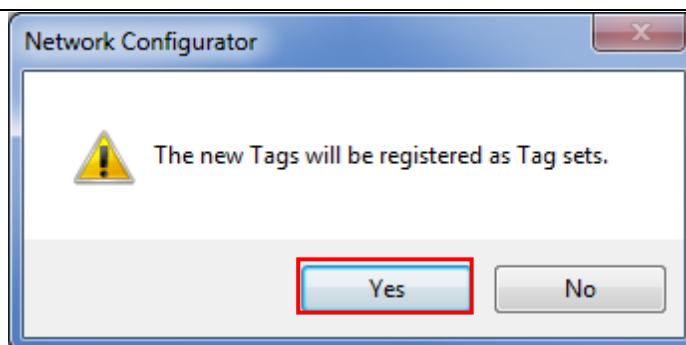

- 12 The Edit Device Parameters Dialog Box is displayed again. Select the **Connections** Tab.

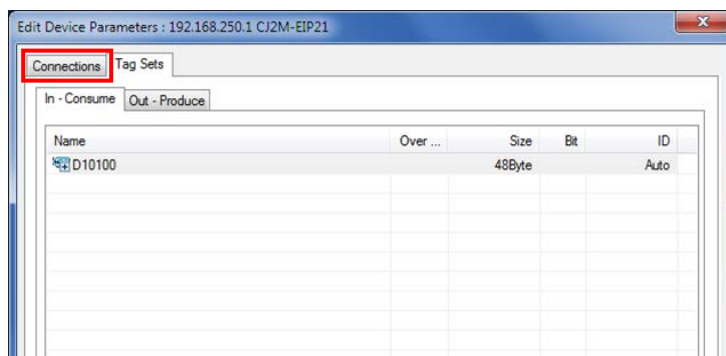

7.4.4. Setting the Connections

Associate the tags of the target device (that receives the open request) with the tags of the originator device (that requests opening).

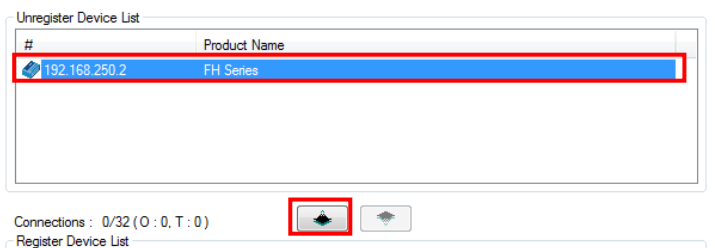
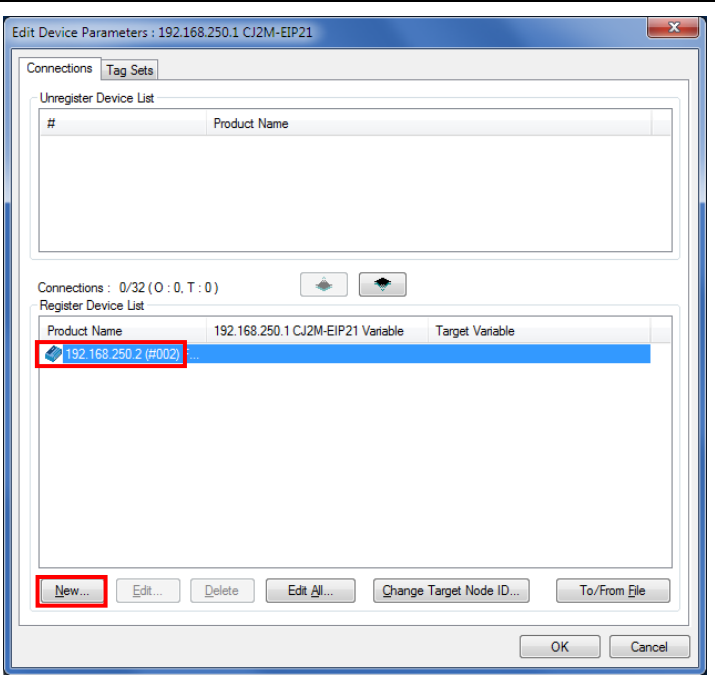
<p>1 Select <i>192.168.250.2</i> in the <i>Unregister Device List</i> Field. Click the Down Arrow Button that is shown in the dialog box.</p>	 <p>Unregister Device List</p> <table border="1"> <thead> <tr> <th>#</th> <th>Product Name</th> </tr> </thead> <tbody> <tr> <td>192.168.250.2</td> <td>FH Series</td> </tr> </tbody> </table> <p>Connections : 0/32 (O : 0, T : 0)</p> <p>Register Device List</p>	#	Product Name	192.168.250.2	FH Series		
#	Product Name						
192.168.250.2	FH Series						
<p>2 <i>192.168.250.2</i> is registered in the <i>Register Device List</i> Field. Select <i>192.168.250.2</i> and click the New Button.</p>	 <p>Edit Device Parameters : 192.168.250.1 CJ2M-EIP21</p> <p>Connections : 0/32 (O : 0, T : 0)</p> <p>Register Device List</p> <table border="1"> <thead> <tr> <th>Product Name</th> <th>192.168.250.1 CJ2M-EIP21 Variable</th> <th>Target Variable</th> </tr> </thead> <tbody> <tr> <td>192.168.250.2 (#002)</td> <td></td> <td></td> </tr> </tbody> </table> <p>New... Edit... Delete Edit All... Change Target Node ID... To/From File</p> <p>OK Cancel</p>	Product Name	192.168.250.1 CJ2M-EIP21 Variable	Target Variable	192.168.250.2 (#002)		
Product Name	192.168.250.1 CJ2M-EIP21 Variable	Target Variable					
192.168.250.2 (#002)							

- 3 The Edit Connection Dialog Box is displayed. Select **Consume Data From/Produce Data To** from the Connection I/O Type pull-down list. Set the values listed in the following table to the *Originator Device* Field and the *Target Device* Field.

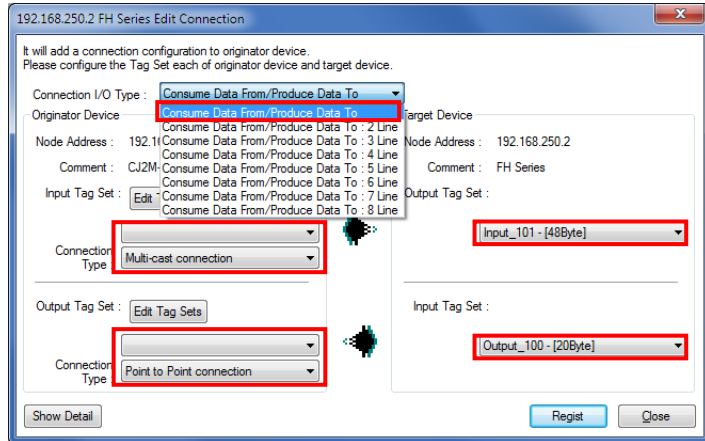

■ Settings of connection allocation

Connection allocation		Set value
Connection I/O Type		Consume Data From / Produce Data To
Originator Device	Input Tag Set	D10100-[48 Byte]
	Connection Type	Point to Point connection
	Output Tag Set	D10000-[20 Byte]
	Connection Type	Point to Point connection
Target Device	Output Tag Set	Input_101-[48 Byte]
	Input Tag Set	Output_100-[20 Byte]

- 4 Confirm that the settings are correct, and click the **Show Detail** Button.

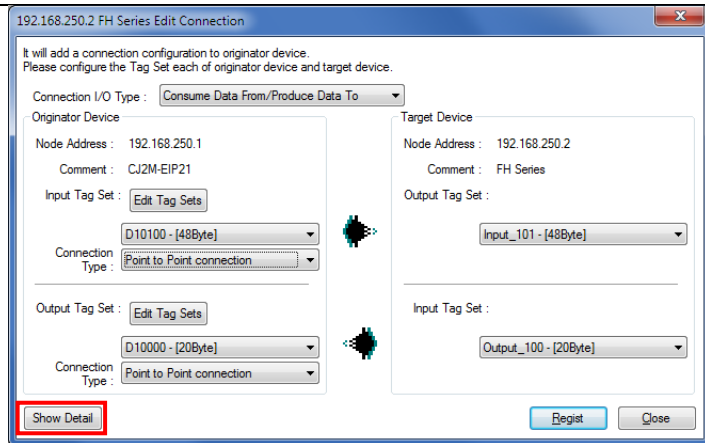

- 5 The *Detail parameter* Field is displayed. Set the following values.
- Packet Interval (RPI): 50.0 ms
 - Timeout Value: *Packet Interval (RPI) x 4*

Hide Detail

Detail Parameter

Packet Interval (RPI) : 50.0 ms (1.0 - 10000.0 ms)

Timeout Value : Packet Interval (RPI) x 4

The same dialog box as step 4 is displayed again if you click the **Hide Detail** Button.



Precautions for Correct Use

Set RPI to 4ms or longer for the FH Sensor Controller.



Precautions for Correct Use

When the measurement interval is short, the measurement processing load is high, or command processing for operations such as scene group changing is time-consuming, the FH Sensor Controller prioritizes measurement and control processing over communication processing. As a result, communication between an external device and the FH Sensor Controller may be temporarily interrupted, and a communication error may occur.

In this case, set the timeout value as shown below.

Packet Interval (RPI value) × Timeout Value > FH Sensor Controller's Processing Time

For details on the Timeout Value of the FH Sensor Controller, refer to *EtherNet/IP Communications* in *Communicating with EtherNet/IP* in *Section 2. Methods for Connecting and Communicating with External Devices* of the *Vision Sensor FH/FZ5 Series Vision System User's Manual for Communications Settings* (Cat. No. Z342).

- 6 Click the **Regist** Button.

Regist Close

- 7 The Edit Connection Dialog Box is displayed again. Click the **Close** Button.

Regist Close

- 8 The Edit Device Parameters Dialog Box is displayed again. Click the **OK** Button.

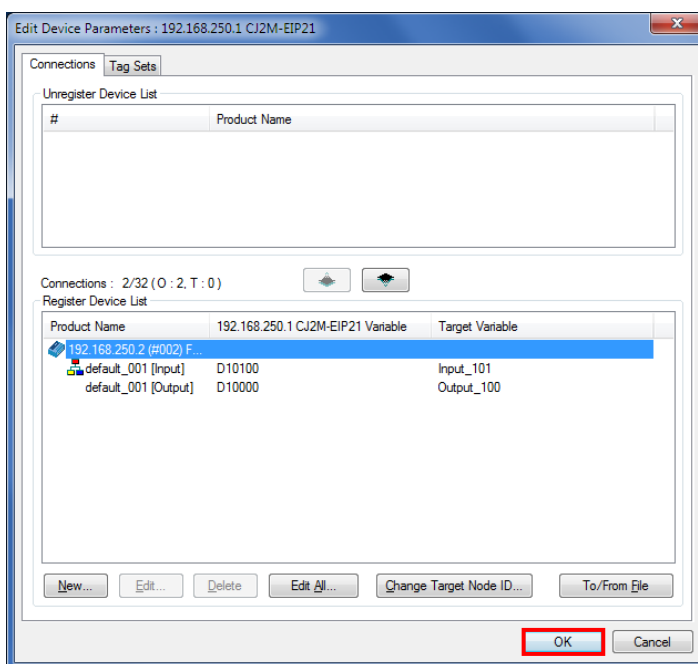

- 9 When the connection setting is completed, the registered node address is displayed under the device icon of node 2 on the Network Configuration Pane.

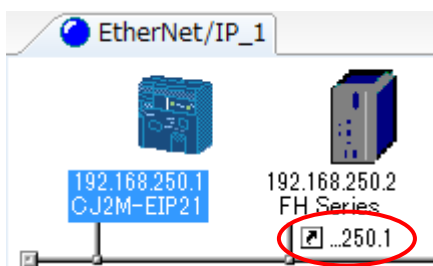

7.4.5. Transferring the Tag Data Link Parameters

Transfer the set tag data link parameters to the PLC.

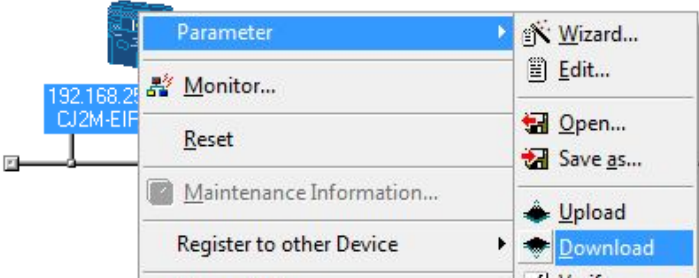
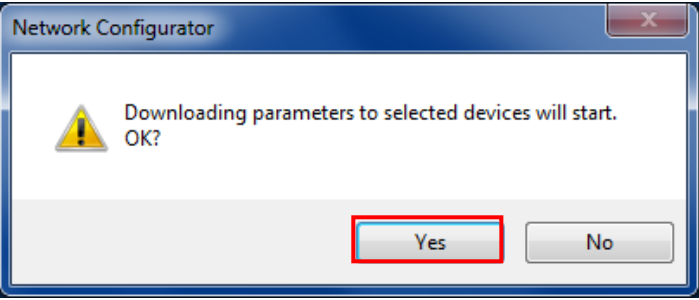
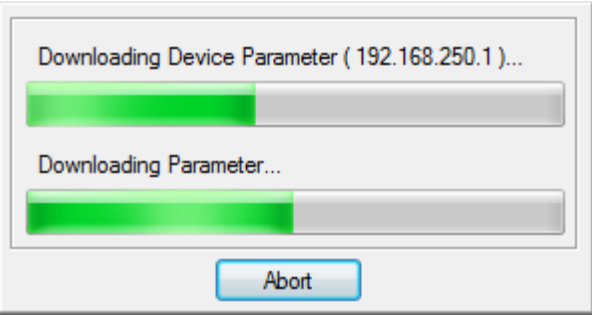
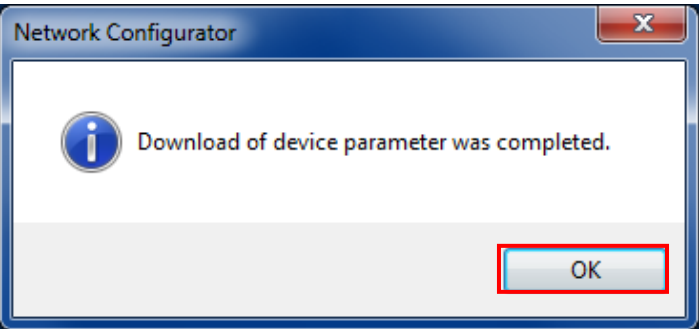
<p>1 Right-click the device icon of node 1 on the Network Configuration Pane and select Parameter - Download.</p>	
<p>2 The dialog box on the right is displayed. Confirm that there is no problem and click the Yes Button.</p>	
<p>3 The tag data link parameters are downloaded from Network Configurator to the PLC.</p>	
<p>4 The dialog box on the right is displayed. Check the contents and click the OK Button.</p>	

7.5. Checking the EtherNet/IP Communications

Confirm that the EtherNet/IP tag data links are operated normally.

7.5.1. Checking the Connection Status

Check the connection status of EtherNet/IP.

- 1 Confirm that the EtherNet/IP tag data links are operated normally by checking the LED indicators of the PLC (EtherNet/IP Unit).

The LED indicators in normal status are as follows:

- MS: Green lit
- NS: Green lit
- COMM: Yellow lit
- 100M or 10M: Yellow lit



- 2 Check the LED indicators on the FH Sensor Controller.

The LED indicators in normal status are as follows:

- POWER: Green lit
- Error: Not lit
- NET RUN2: Green lit
- LINK/ACT2: Orange flashing
(Flashing while packets are being sent and received)

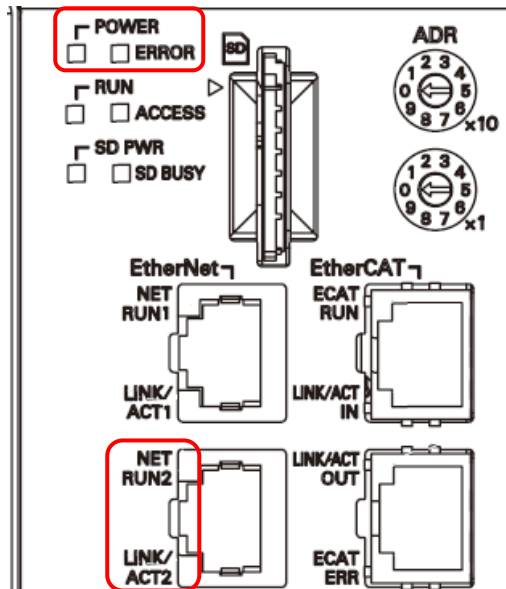

- 3 Confirm that the tag data links are normally in operation by checking the status information on the Monitor Device Window of the Network Configurator.

Right-click the device icon of node 1 on the Network Configuration Pane and select **Monitor**.

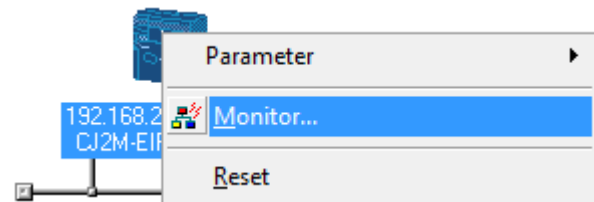

- 4 The dialog box on the right displays the Status 1 Tab Page of the Monitor Device Dialog Box.

When the same check boxes are selected as shown on the right, the tag data links are normally in operation.

Click the **Close** Button.

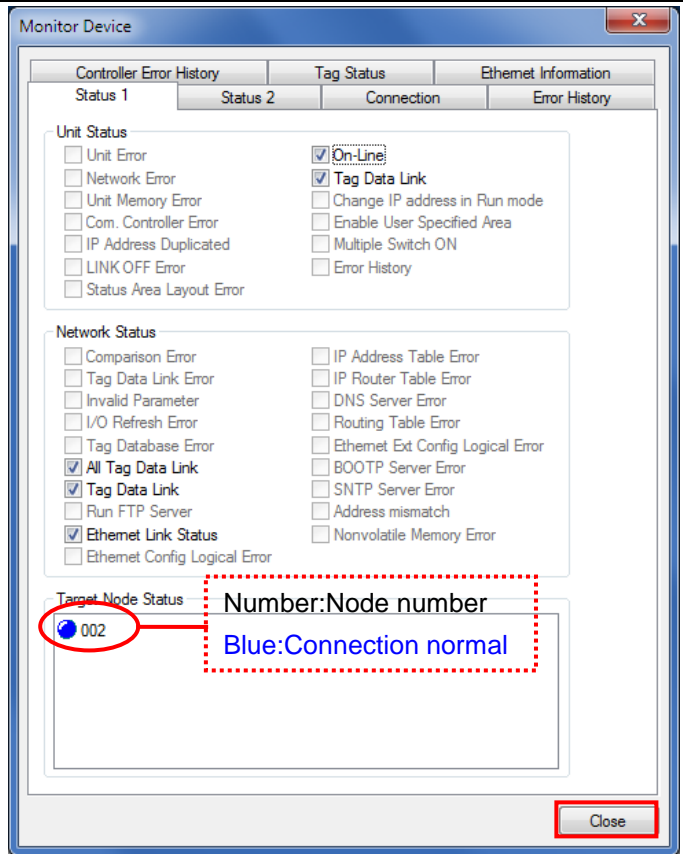

- 5 Select **Disconnect** from the Network Menu to go offline.

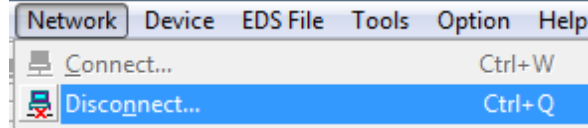

- 6 The color of the icon on the figure changes from blue to gray.

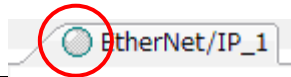

- 7 Select **Exit** from the File Menu to exit the Network Configurator.

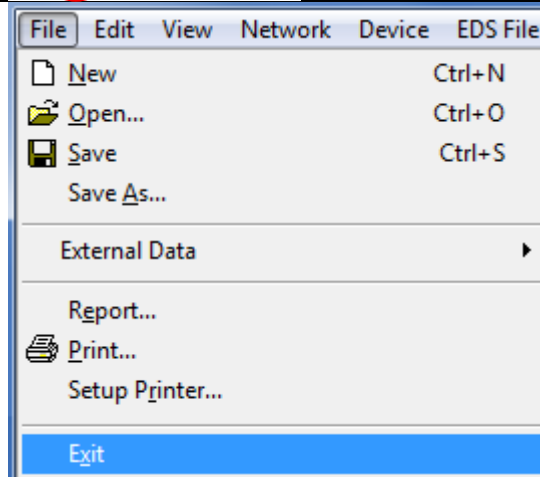

7.5.2. Checking the Sent and Received Data

Confirm that the correct data are sent and received.

Caution

If the PLC memory is changed by malfunction during monitoring power flow and present value status in the Ladder Section window or monitoring present values in the Watch window, the connected devices may malfunction, regardless of the operating mode of the CPU Unit.

Confirm safety sufficiently before monitoring power flow and present value status in the Ladder Section window or before monitoring present values in the Watch window.

- 1 Confirm that the PLC is in Stop/Program Mode.

* If the PLC is not in Stop/Program Mode, change to Stop/Program Mode by referring to step 1 of 7.3.3. *Creating the I/O Table and setting IP Addresses.*

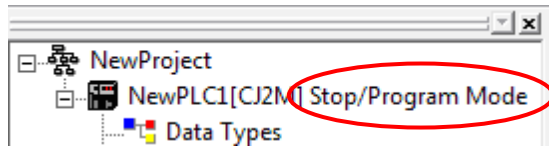

- 2 Select **Edit - Memory** from the PLC Menu.

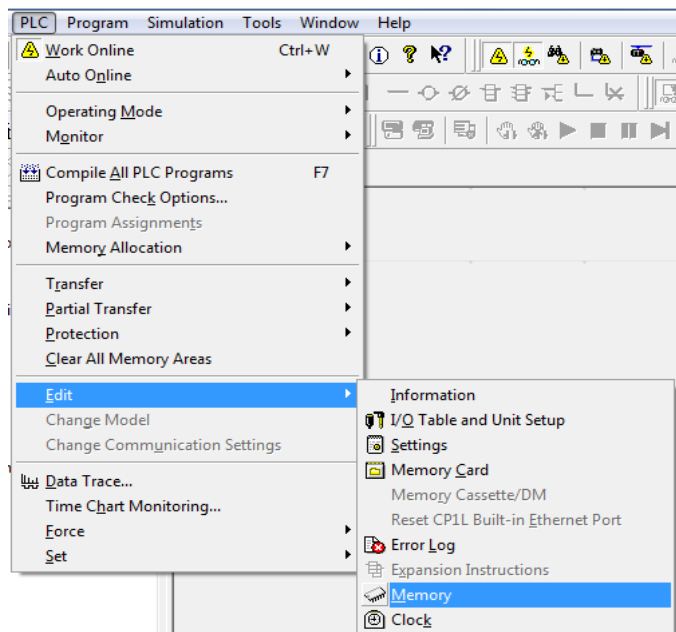

- 3 The PLC Memory Window is displayed. Double-click **D** from the list in the PLC Memory Window.

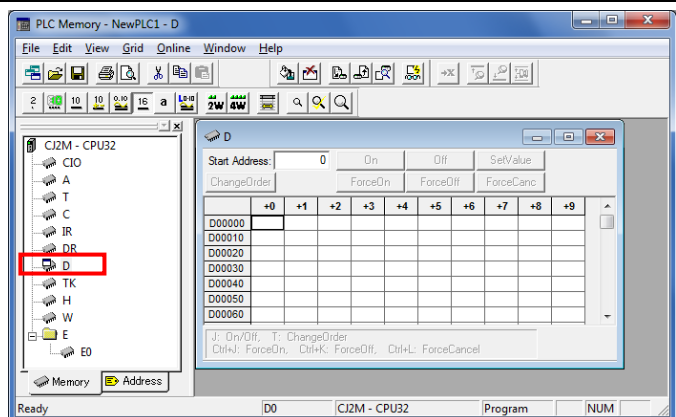

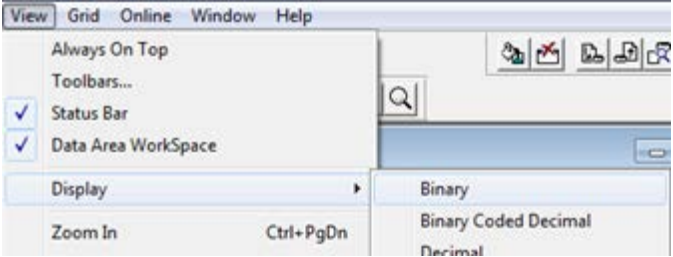
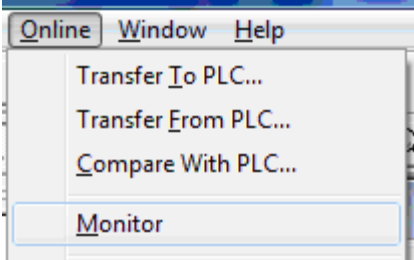
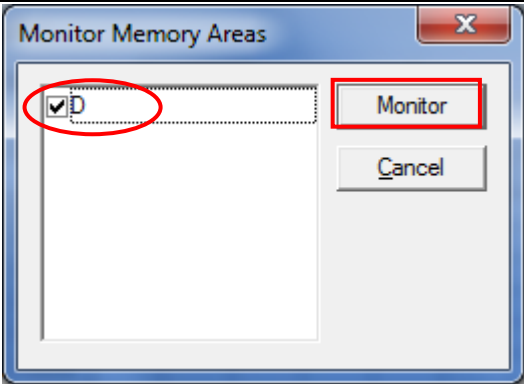
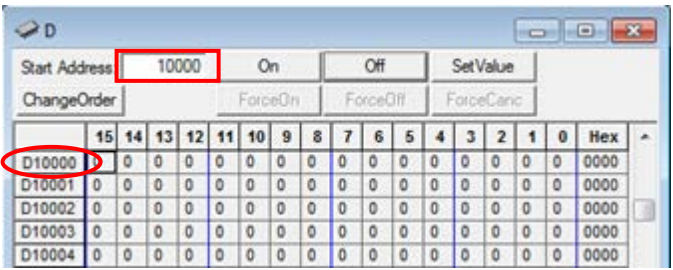
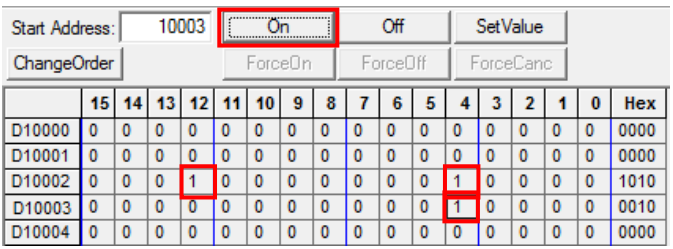
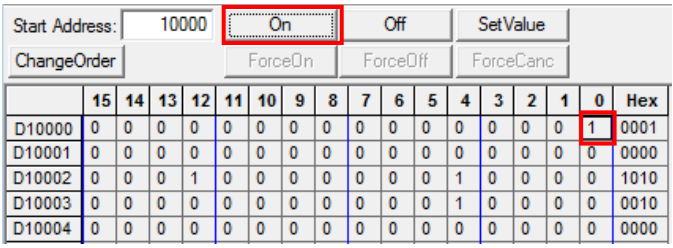
- 4 Select **Display - Binary** from the View Menu.
- 
- 5 Select **Monitor** from the Online Menu.
- 
- 6 The Monitor Memory Areas Dialog Box is displayed. Confirm that the **D** Check Box is selected and click the **Monitor** Button.
- 
- 7 Enter **10000** in the Start Address Field in the D Window.
- Confirm that the start address changes to **D10000**.
- 
- 8 Select bits 12 and 4 of D10002 and bit 4 of D10003, and then click the **On** Button. (After turning them ON, the values change to 1.)
- 
- Then, turn ON bit 0 of D10000.
- *D10002 and D10003 are an area for a command code and contain 00101010(Hex) (Measurement command). Bit 0 of D10000 is a command execution (EXE) flag.
- 

- 9 After completing the measurement, OK is displayed on the Monitor.



- 10 Enter 10100 in the Start Address Field in the D Window. Confirm that the start address changes to D10100.

	15	14	13	12	11	10	9	8
D10100	0	0	0	0	0	0	0	0
D10101	0	0	0	0	0	0	0	0
D10102	0	0	0	1	0	0	0	0

- 11 Confirm that values of D10100 to D10105 are set as shown below.
 D10100:bit15(ERR): 0
 D10103/D10102
 (command code):0010/1010
 : Setting data in step 8
 D10105/D10104
 (response code):
 0000/0000: Normal end

	15	14	13	12	11	10	9	8	7	6	5	4	3	2	1	0	Hex
D10100	0	0	0	0	0	0	0	0	0	0	0	0	0	0	0	0	0000
D10101	0	0	0	0	0	0	0	0	0	0	0	0	0	0	0	0	0000
D10102	0	0	0	1	0	0	0	0	0	0	0	1	0	0	0	0	1010
D10103	0	0	0	0	0	0	0	0	0	0	0	1	0	0	0	0	0010
D10104	0	0	0	0	0	0	0	0	0	0	0	0	0	0	0	0	0000
D10105	0	0	0	0	0	0	0	0	0	0	0	0	0	0	0	0	0000
D10106	0	0	0	0	0	0	0	0	0	0	0	0	0	0	0	0	0000

8. Initialization Method

This document provides the explanation of the setting procedure based on the factory default setting.

Some settings may not be applicable as described in this document unless you use the devices with the factory default setting.

8.1. Initializing the PLC

To initialize the settings of the PLC, it is necessary to initialize the CPU Unit and EtherNet/IP Unit. Change the PLC to Program mode before the initialization.

8.1.1. EtherNet/IP Unit

(1) Select **Edit - I/O Table and Unit Setup** from the PLC Menu of the CX-Programmer.

Right-click the EtherNet/IP Unit on the PLC IO Table Window and select **Unit Setup** from the menu.

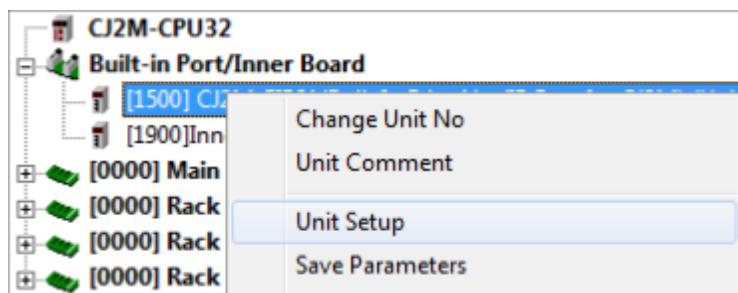

(2) Click the **Restart** Button on the Edit Parameters Dialog Box.

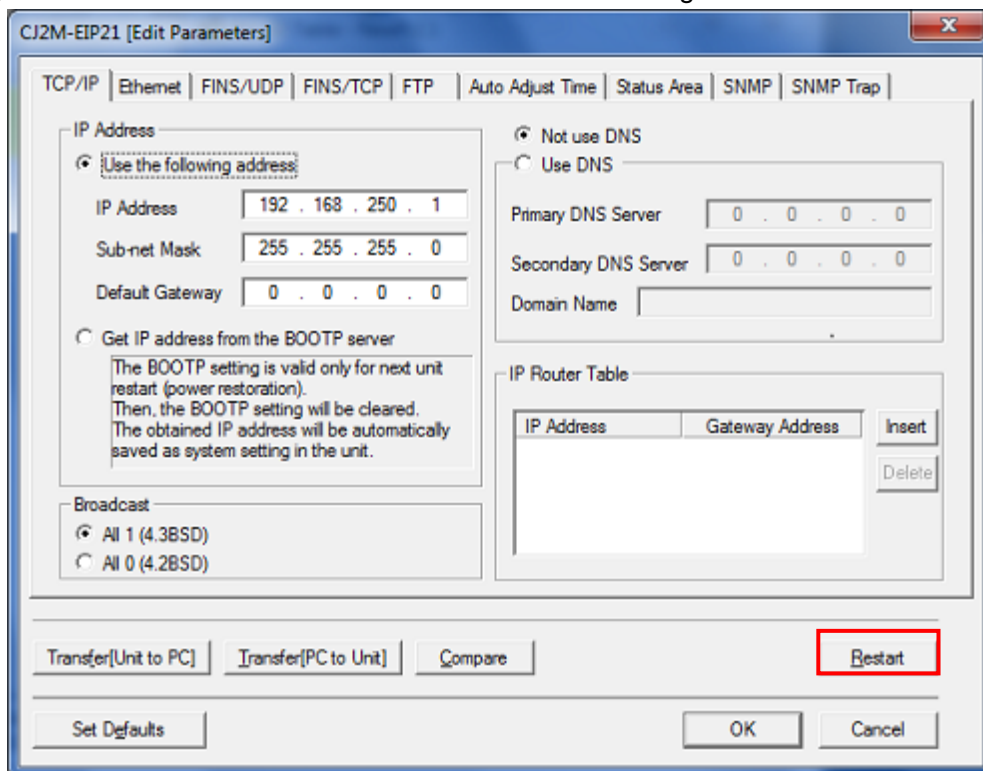

- (3) A confirmation dialog box on the right is displayed. Confirm that there is no problem and click the **Yes** Button. Next, the Restart Unit Dialog Box is displayed. Select the *Return to out-of-box configuration, and then emulate cycling power* Option, and click the **OK** Button. A dialog box indicating the execution is completed is displayed. Check the contents and click the **OK** Button.

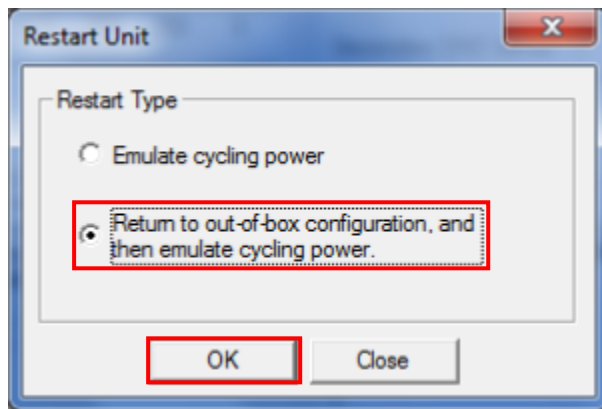

8.1.2. CPU Unit

To initialize the settings of the CPU Unit, select **Clear All Memory Areas** from the PLC Menu of the CX-Programmer. The Confirm All Memory Area Clear Dialog Box is displayed. Select the *Initialize* Option and click the **OK** Button.

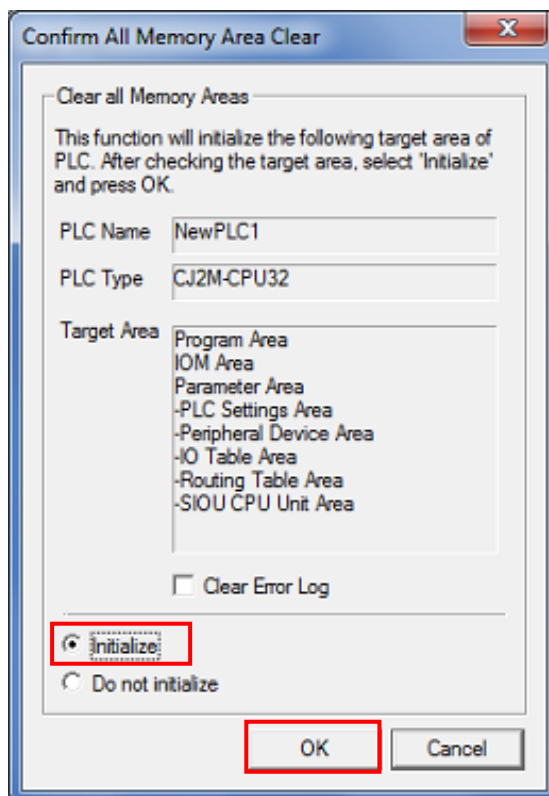

8.2. Initializing the FH Sensor Controller

For information on how to initialize the FH Sensor Controller, refer to *Initializing the Controller* in *Section 1. Before Operation of the Vision Sensor FH/FZ5 Series Vision System User's Manual* (Cat. No. Z340).

9. Revision History

Revision code	Date of revision	Revision reason and revision page
01	October 31, 2013	First edition
02	March 19, 2015	Screens changed due to the upgraded version of FH Sensor Controller. Connection settings for both input and output revised to Point to Point connection. (Section 6.1.2. added, screens in steps 3 to 5 in 7.4.4. revised) Setting up Output control to Handshaking recommended. (items and information in <i>Section 6.1.1.</i> added, steps 16 to 18 in <i>Section 7.2.1.</i> added, Precautions after step 5 in <i>Section 7.7.4.</i> added)

OMRON Corporation Industrial Automation Company

Tokyo, JAPAN

Contact: www.ia.omron.com

Regional Headquarters

OMRON EUROPE B.V.

Wegalaan 67-69-2132 JD Hoofddorp
The Netherlands

Tel: (31)2356-81-300/Fax: (31)2356-81-388

OMRON ELECTRONICS LLC

One Commerce Drive Schaumburg,
IL 60173-5302 U.S.A.

Tel: (1) 847-843-7900/Fax: (1) 847-843-7787

OMRON ASIA PACIFIC PTE. LTD.

No. 438A Alexandra Road # 05-05/08 (Lobby 2),
Alexandra Technopark,
Singapore 119967

Tel: (65) 6835-3011/Fax: (65) 6835-2711

OMRON (CHINA) CO., LTD.

Room 2211, Bank of China Tower,
200 Yin Cheng Zhong Road,
PuDong New Area, Shanghai, 200120, China

Tel: (86) 21-5037-2222/Fax: (86) 21-5037-2200

Authorized Distributor:

© OMRON Corporation 2015 All Rights Reserved.
In the interest of product improvement,
specifications are subject to change without notice.

Cat. No. P575-E1-02

0315(-)