

Machine Automation Controller NJ-series

# IO-Link Connection Guide (EtherCAT(R) Host Communications)

## OMRON Corporation

Photoelectric Sensor  
(E3Z-series IO-Link)

[IO-Link Master Unit]

OMRON Corporation

NX-series IO-Link Master Unit (NX-ILM[ ][ ][ ]) )

NX-series EtherCAT Coupler Unit (NX-ECC20[ ][ ]) )



Network  
Connection  
Guide

### **About Intellectual Property Rights and Trademarks**

---

Microsoft product screen shots reprinted with permission from Microsoft Corporation.

Windows is a registered trademark of Microsoft Corporation in the USA and other countries.

EtherCAT(R) is registered trademark and patented technology, licensed by Beckhoff Automation GmbH, Germany.

Sysmac is a trademark or registered trademark of OMRON Corporation in Japan and other countries for OMRON factory automation products.

Company names and product names in this document are the trademarks or registered trademarks of their respective companies.

---

## Table of Contents

<b>1. Related Manuals</b> .....	<b>1</b>
<b>2. Terms and Definitions</b> .....	<b>2</b>
<b>3. Precautions</b> .....	<b>3</b>
<b>4. Overview</b> .....	<b>4</b>
<b>5. Applicable Devices and Device Configuration</b> .....	<b>5</b>
5.1. Applicable Devices .....	5
5.2. Device Configuration .....	6
<b>6. Communications Settings</b> .....	<b>8</b>
6.1. EtherCAT Connection Parameter .....	8
6.2. IO-Link Connection Parameter .....	8
6.3. Slave Terminal Configuration and Device Names .....	8
6.4. Device Variables.....	9
<b>7. IO-Link Connection Procedure</b> .....	<b>11</b>
7.1. Work Flow .....	11
7.2. Slave Terminal Setup .....	13
7.3. Network Configuration for Host Communications.....	16
7.4. IO-Link Master Unit Setup.....	20
7.5. Controller Setup .....	23
7.6. IO-Link Communication Status Check.....	30
<b>8. Initialization method</b> .....	<b>39</b>
8.1. Initializing Controller.....	39
8.2. Initializing Slave Terminal.....	39
<b>9. Revision History</b> .....	<b>42</b>

## 1. Related Manuals

To ensure system safety, make sure to always read and follow the information provided in all Safety Precautions and Precautions for Safe Use in the manuals for each device which is used in the system.

Cat. No.	Model	Manual name
W500	NJ501-□□□□ NJ301-□□□□ NJ101-□□□□	NJ-series CPU Unit Hardware User's Manual
W501	NJ501-□□□□ NJ301-□□□□ NJ101-□□□□	NJ/NX-series CPU Unit Software User's Manual
W505	NJ501-□□□□ NJ301-□□□□ NJ101-□□□□	NJ/NX-series CPU Unit Built-in EtherCAT(R) Port User's Manual
W504	SYSMAC-SE2□□□□	Sysmac Studio Version 1 Operation Manual
W519	NX-ECC20□	NX-series EtherCAT(R) Coupler Unit User's Manual
W567	NX-ILM□□□	NX-series IO-Link Master Unit User's Manual
W570	NX-ILM□□□ GX-ILM□□□	IO-Link System User's Manual
9540404-3	E3Z-□8□-IL□	PHOTOELECTRIC SENSOR INSTRUCTION SHEET
9541795-1	E3Z-□8□-IL□	Photoelectric Sensor INDEX LIST

## 2. Terms and Definitions

Term	Explanation and Definition
IO-Link device	A device with a sensor or an actuator that can perform IO-Link communications with an IO-Link master.
IO-Link master	A device that performs IO-Link communications with IO-Link devices in an IO-Link System and that simultaneously functions as a slave for host communications. “IO-Link Master Unit” is used to refer to a specific Unit in this document.
IO-Link Mode	A communication mode of an IO-Link master to perform IO-Link communications with IO-Link devices.
Cyclic communications	Communications that exchange data in a fixed period with no need for programming.
I/O data	All target data in cyclic communications with a host. IO-Link Systems contain the following two types of I/O data. <ul style="list-style-type: none"> <li>• Target data in cyclic communications with a host in an IO-Link master</li> <li>• Target data in IO-Link devices for cyclic communications with an IO-Link master</li> </ul>
Process data	I/O data in IO-Link devices. You can allocate a maximum of 32 bytes of process data in a master.
IODD file	A definition file for an IO-Link device. The parameter settings for an IO-Link device can be made by installing this file in CX-ConfiguratorFDT.
Slave unit	A generic name for a device that performs EtherCAT communications with an EtherCAT master in an EtherCAT system. There are various types of slaves such as servo drives that handle position data and I/O terminals that handle bit signals.
Node address	A node address is an address to identify a unit connected to EtherCAT.
ESI file	An ESI file contains information unique to EtherCAT slave units in XML format. Installing an ESI file enables Sysmac Studio to allocate EtherCAT slave process data and make other settings.

## 3. Precautions

- (1) Understand the specifications of devices which are used in the system. Allow some margin for ratings and performance. Provide safety measures, such as installing a safety circuit, in order to ensure safety and minimize the risk of abnormal occurrence.
- (2) To ensure system safety, make sure to always read and follow the information provided in all Safety Precautions and Precautions for Safe Use in the manuals for each device which is used in the system.
- (3) The user is encouraged to confirm the standards and regulations that the system must conform to.
- (4) It is prohibited to copy, to reproduce, and to distribute a part or the whole of this document without the permission of OMRON Corporation.
- (5) The information contained in this document is current as of July 2016. It is subject to change for improvement without notice.

The following notations are used in this document.



**WARNING**

Indicates a potentially hazardous situation which, if not avoided, may result in minor or moderate injury, or may result in serious injury or death. Additionally there may be significant property damage.



**Caution**

Indicates a potentially hazardous situation which, if not avoided, may result in minor or moderate injury or property damage.



### Precautions for Correct Use

Precautions on what to do and what not to do to ensure proper operation and performance.



### Additional Information

Additional information to read as required.

This information is provided to increase understanding or make operation easier.

### Symbol



The filled circle symbol indicates operations that you must do. The specific operation is shown in the circle and explained in the text. This example shows a general precaution for something that you must do.

## 4. Overview

This document describes the procedures for connecting E3Z-series IO-Link Photoelectric Sensor (hereinafter referred to as Photoelectric Sensor) that is connected via IO-Link to IO-Link Master Unit (NX-ILM[ ][ ][ ][ ]) to NJ-series Machine Automation Controller (hereinafter referred to as Controller) via EtherCAT through EtherCAT Coupler Unit (NX-ECC20[ ]) to which IO-Link Master Unit is connected and also for checking their connection status - all of which are produced by OMRON Corporation.

Refer to *Section 6. Communications Settings* and *Section 7. IO-Link Connection Procedure* to understand setting methods and key points to perform cyclic communications in the IO-Link system.

In this document, a generic EtherCAT slave for EtherCAT communications is called "slave unit", and a specific EtherCAT slave configured of EtherCAT Coupler Unit and IO-Link Master Unit is called "Slave Terminal".

<Slave Terminal Configuration>

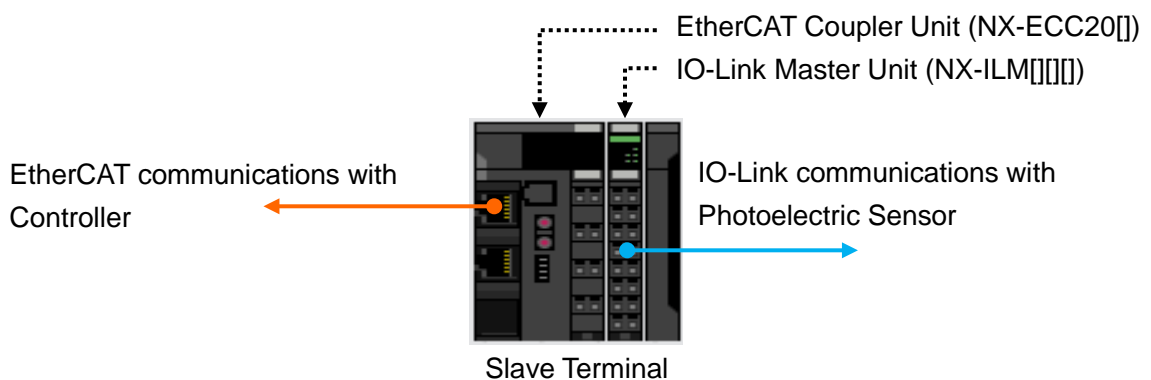

## 5. Applicable Devices and Device Configuration

### 5.1. Applicable Devices

The applicable devices are as follows:

Manufacturer	Name	Model
OMRON	NJ-series CPU Unit	NJ501-□□□□ NJ301-□□□□ NJ101-□□□□
OMRON	NX-series EtherCAT Coupler Unit	NX-ECC20□
OMRON	NX-series IO-Link Master Unit	NX-ILM□□□
OMRON	E3Z-series IO-Link Photoelectric Sensor	E3Z-□8□-IL□



#### Precautions for Correct Use

In this document, the devices with models and versions listed in 5.2. *Device Configuration* are used as examples of applicable devices to describe the procedures for connecting the devices and checking their connections.

You cannot use devices with versions lower than the versions listed in 5.2.

To use the above devices with models not listed in 5.2. or versions higher than those listed in 5.2., check the differences in the specifications by referring to the manuals before operating the devices.



#### Additional Information

This document describes the procedures for establishing the network connections.

It does not provide information on operation, installation, wiring method, device functionality, or device operation, which is not related to the connection procedures.

Refer to the manuals or contact the device manufacturer.



**5.2. Device Configuration**

The hardware components to reproduce the connection procedures in this document are as follows:

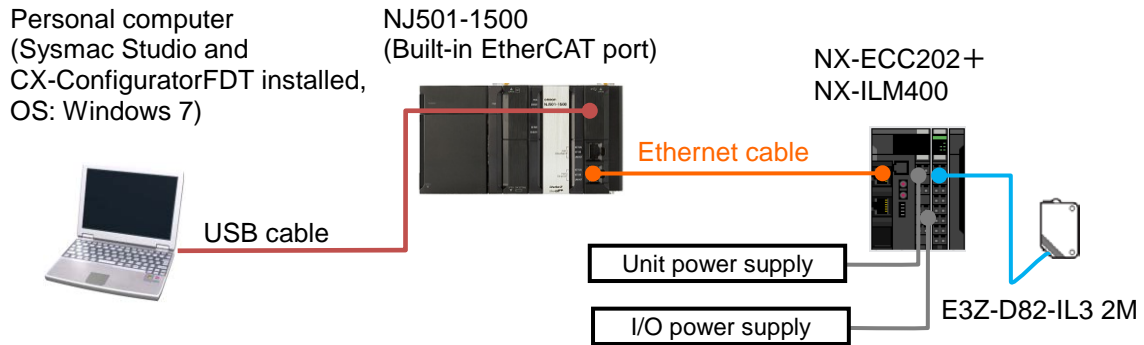

Manufacturer	Name	Model	Version
OMRON	NJ-series CPU Unit (Built-in EtherCAT port)	NJ501-1500	Ver.1.12
OMRON	Power Supply Unit	NJ-PA3001	
OMRON	Sysmac Studio	SYSMAC-SE2[ ][ ]	Ver.1.16
OMRON	CX-ConfiguratorFDT	(Included in Sysmac Studio)	Ver.2.2
-	Personal computer (OS: Windows 7)	-	
-	USB cable (USB 2.0 type B connector)	-	
OMRON	Ethernet cable (with industrial Ethernet connector)	XS5W-T421-[ ]M[ ]-K	
OMRON	NX-series EtherCAT Coupler Unit	NX-ECC202	Ver.1.2
OMRON	NX-series IO-Link Master Unit	NX-ILM400	Ver.1.0
-	Unit power supply (24 VDC)	-	
-	I/O power supply (24 VDC)	-	
OMRON	IO-Link Photoelectric Sensor	E3Z-D82-IL3 2M	Ver.1.00

**Precautions for Correct Use**

The connection line of EtherCAT communications cannot be shared with other Ethernet networks. Do not use devices for Ethernet such as a switching hub.

Use an Ethernet cable (double shielding with aluminum tape and braiding) of Category 5 or higher, and use a shielded connector of Category 5 or higher.

Connect the cable shield to the connector hood at both ends of the cable.

**Precautions for Correct Use**

Update Sysmac Studio and CX-ConfiguratorFDT to the version specified in this *Clause 5.2.* or to a higher version. If you use a version higher than the one specified, the procedures and related screenshots described in *Section 7.* and subsequent sections may not be applicable. In that case, use the equivalent procedures described in this document by referring to the *Sysmac Studio Version 1 Operation Manual* (Cat. No. W504) and *ConfiguratorFDT Online Help.*



### **Additional Information**

---

For specifications of Ethernet cables and network wiring, refer to *Section 4. EtherCAT Network Wiring* of the *NJ/NX-series CPU Unit Built-in EtherCAT(R) Port User's Manual* (Cat. No. W505).

---



### **Additional Information**

---

For specifications of Unit and I/O power supplies for Slave Terminal, refer to the *NX-series EtherCAT(R) Coupler Unit User's Manual* (Cat. No. W519).

---



### **Additional Information**

---

The system configuration in this document uses USB for the connection between Personal computer and Controller. For information on how to install the USB driver, refer to *A-1 Driver Installation for Direct USB Cable Connection* in *Appendices* of the *Sysmac Studio Version 1 Operation Manual* (Cat. No. W504).

---

## 6. Communications Settings

This section describes the contents of parameter and device variable settings that are all defined in this document.

### 6.1. EtherCAT Connection Parameter

The parameter required for connecting Controller and Slave Terminal via EtherCAT is shown below.

<Slave Terminal Setting>

Item	Set value	Remarks
Node address	1	Set the address using the hardware switches on Slave Terminal.

### 6.2. IO-Link Connection Parameter

The parameter required for connecting IO-Link Master Unit and Photoelectric Sensor via IO-Link is shown below.

In this document, Photoelectric Sensor is connected to Port 1 on IO-Link Master Unit.

<IO-Link Master Unit Setting>

Item name	Value
Port1 IO-Link Device Configuration Data / Master Control	IO-Link Mode (Default)

### 6.3. Slave Terminal Configuration and Device Names

The Slave Terminal configuration and device names are shown below.

The default values are used for the device names. For slave units, the default device names are "E" followed by a serial number that starts from 001.

For NX Units, the default device names are N followed by a serial number that starts from 1.

<Slave Terminal configuration and device names>

NX Unit number	Name	Model	Device name
0	EtherCAT Coupler Unit	NX-ECC202	E001
1	IO-Link Master Unit	NX-ILM400	N1



## 6.4. Device Variables

The I/O data (process data) for Photoelectric Sensor are allocated to the Controller's device variables as PDO communications data. The device variables are named automatically from a combination of the device names and the port names.

The device variables and the data types are shown below.



### Additional Information

With Sysmac Studio, two methods can be used to specify an array for a data type.

After specifying, (1) is converted to (2), and the data type is always displayed as (2).

(1) BOOL[16] / (2) ARRAY[0..15] OF BOOL

In this document, the data type is simplified by displaying BOOL[16].

(The example above means a BOOL data type with sixteen array elements.)

#### ■ Output area (Controller to Slave Terminal)

Device name	Variable	Data Type	Description
N1	N1_Port1_Output_Data01	BYTE[2]	Port1 Output Data01
	N1_Port2_Output_Data01	BYTE[2]	Port2 Output Data01
	N1_Port3_Output_Data01	BYTE[2]	Port3 Output Data01
	N1_Port4_Output_Data01	BYTE[2]	Port4 Output Data01

#### ■ Input area (Slave Terminal to Controller)

Device name	Variable	Data Type	Description
E001	E001_Sysmac_Error_Status	BYTE	Sysmac error status on Slave Terminal
	E001_Observation	BOOL	Observation
	E001_Minor_Fault	BOOL	Minor Fault
	E001_Partial_Fault	BOOL	Partial Fault
	E001_Major_Fault	BOOL	Major Fault
	E001_NX_Unit_Registration_Status_125	BOOL[126]	Status whether the NX Unit is registered to Unit configuration information or not.
	E001_NX_Unit_I_O_Data_Active_Status_125	BOOL[126]	Status whether the NX Unit I/O data is controlled or not.
N1	N1_I_O_Port_Status	WORD	I/O Port Status
	N1_Port1_IN_Data_Enable	BOOL	Port1 IN Data Enable
	N1_Port2_IN_Data_Enable	BOOL	Port2 IN Data Enable
	N1_Port3_IN_Data_Enable	BOOL	Port3 IN Data Enable
	N1_Port4_IN_Data_Enable	BOOL	Port4 IN Data Enable
	N1_Communication_Module_Error	BOOL	Communication Module Error
	N1_IO_Pwr_On	BOOL	IO Power On
	N1_Port1_2_I_O_Port_Error_Status	WORD	Port1_2 I/O Port Error Status
	N1_Port1_Communication_Error	BOOL	Port1 Communication Error
	N1_Port1_Short_Error	BOOL	Port1 Short Error
	N1_Port1_Compare_Error	BOOL	Port1 Compare Error
	N1_Port1_Device_IO_Size_Error	BOOL	Port1 Device IO Size Error
	N1_Port1_Device_Error	BOOL	Port1 Device Error
	N1_Port1_Device_Information	BOOL	Port1 Device Warning
	N1_Port1_PDO_Error	BOOL	Port1 PDO Error
	N1_Port2_Communication_Error	BOOL	Port2 Communication Error
	: (Same status as for Port 1)	:	:
N1_Port3_4_I_O_Port_Error_Status	WORD	Port3_4 I/O Port Error Status	

N1	N1_Port3_Communication_Error	BOOL	Port3 Communication Error
	: (Same status as for Port 1)	:	:
	N1_Port4_Communication_Error	BOOL	Port4 Communication Error
	: (Same status as for Port 1)	:	:
	N1_Port1_Input_Data01	BYTE[2]	Port1 Input Data01 <Stores the I/O data for Photoelectric Sensor.>
	[0]	BYTE	<Stores Byte0 (PD0).>
	[1]	BYTE	<Stores Byte1 (PD1).>
	N1_Port2_Input_Data01	BYTE[2]	Port2 Input Data01
	N1_Port3_Input_Data01	BYTE[2]	Port3 Input Data01
	N1_Port4_Input_Data01	BYTE[2]	Port4 Input Data01

■I/O data (process data) for Photoelectric Sensor

(Data to be stored in the device variable *N1\_Port1\_Input\_Data01* listed in the table above)

Byte0 (PD0)	割り当て Assignment	詳細 Details
	モニタ出力 Monitor output	センシングの検出量を8bit(0-255)で出力する 詳細は6項を参照。 The Sensing data are output as eight bits (0-255). For details, refer to Section 6
Byte1 (PD1)	割り当て Assignment	詳細 Details
	制御出力1 Control Output1	0 : OFF 1 : ON
	制御出力2 Control Output2	0 : OFF 1 : ON
	— Reserved	0
	遮光不安定検出アラーム Instability Alarm(Light Receiving)	0 : 安定状態 Stable 1 : 不安定状態 Unstable
	入光不安定検出アラーム Instability Alarm(Non-Light Receiving)	0 : 安定状態 Stable 1 : 不安定状態 Unstable
	— Reserved	0
	軽度異常 Warning	負荷短絡やサービステータ異常など、回復可能な要因で動作続行できない場合の診断出力 Diagnostic output when the sensor cannot continue operation due to a recoverable factor such as a load short-circuit or a service data error 0 : 正常 Normal (OFF) 1 : 異常 Error (ON)
重度異常 Error	投光回路破壊等センサ内部に異常が発生しており、交換が必要な場合の診断出力 Diagnostic output when the sensor has an internal error such as the emitting circuit destruction and replacement is needed 0 : 正常 Normal (OFF) 1 : 異常 Error (ON)	

## 7. IO-Link Connection Procedure

This section describes the procedures for connecting Photoelectric Sensor to IO-Link Master Unit via IO-Link and for connecting Controller to Slave Terminal configured of IO-Link Master Unit on the EtherCAT network. The explanations of procedures for setting up Controller and Slave Terminal given in this document are based on the factory default settings.

For the initialization, refer to *Section 8. Initialization Method*.

### 7.1. Work Flow

Take the following steps to connect Photoelectric Sensor to IO-Link Master Unit via IO-Link and to connect Controller to Slave Terminal configured of IO-Link Master Unit on the EtherCAT network.

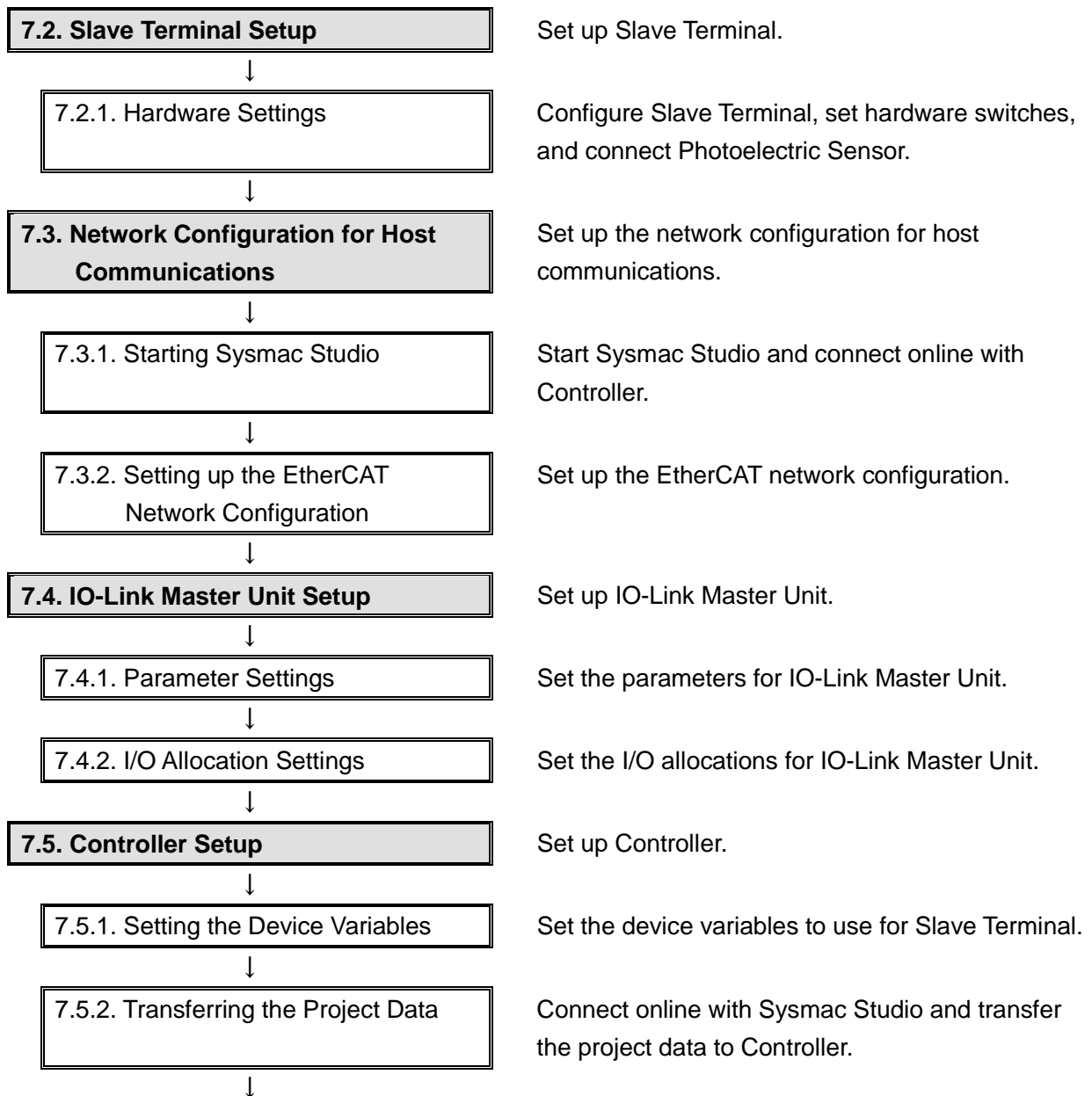

### 7.6. IO-Link Communication Status Check

Confirm that cyclic communications in the IO-Link system performs normally.



#### 7.6.1. Checking the Connection Status

Check the connection status of each device.



#### 7.6.2. Checking the Receive Data

Check that the correct data are received.

## 7.2. Slave Terminal Setup

Set up Slave Terminal.

### 7.2.1. Hardware Settings

Configure Slave Terminal, set hardware switches, and connect Photoelectric Sensor.



#### Precautions for Correct Use

Make sure that the power supply is OFF when you set up.

- 1 Make sure that EtherCAT Coupler Unit and IO-Link Master Unit are powered OFF.

\*If either of them is ON, the settings described in the following steps and subsequent procedures may not be applicable.

- 2 Connect IO-Link Master Unit to EtherCAT Coupler Unit.

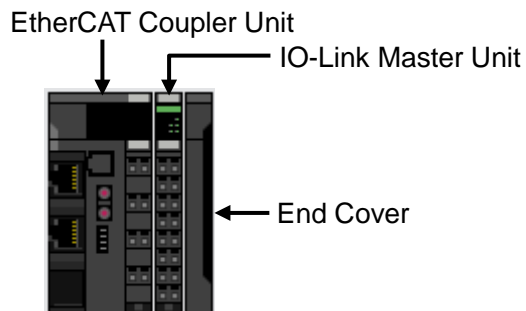

- 3 Check the position of the hardware switches on EtherCAT Coupler Unit by referring to the figure on the right.

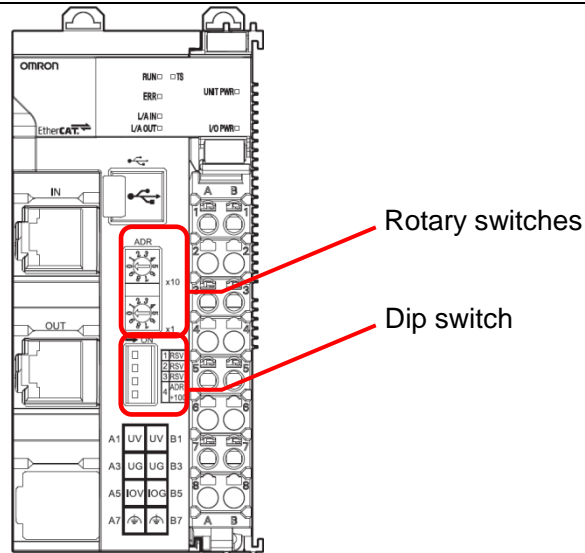



**4** Set Rotary switches and DIP switch as follows:

- Rotary switches
  - x10: 0
  - x1: 1
- DIP switch
  - 4(ADR+100): OFF

\*The node address is set to 1.

**ADR**

Rotary switches

→ ON

DIP switch

---

**5** Connect an Ethernet cable to Communications connector (IN) on EtherCAT Coupler Unit.

Communications connector (IN)

Ethernet cable

---

**6** Connect Unit power supply to Unit power supply terminals on EtherCAT Coupler Unit. Connect I/O power supply to I/O power supply terminals.

\*For details on power supply specifications of NX-series Slave Terminals, refer to *Section 5. Designing the Power Supply System of the NX-series EtherCAT(R) Coupler Unit User's Manual* (Cat. No. W519).

Unit power supply terminals

Unit power supply

I/O power supply

I/O power supply terminals

## 7 Connect Photoelectric Sensor to Port 1 on IO-Link Master Unit.

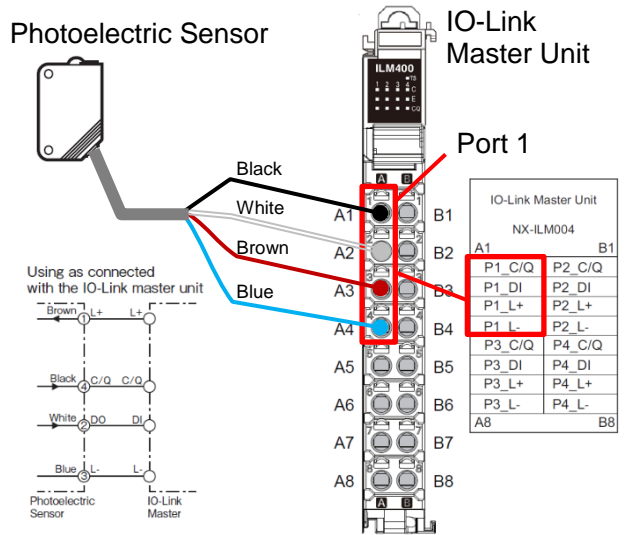

### 7.3. Network Configuration for Host Communications

Set up the network configuration for host communications.

#### 7.3.1. Starting Sysmac Studio

Start Sysmac Studio and connect online with Controller.

Install Sysmac Studio and the USB driver on Personal computer beforehand.



#### Additional Information

For details on the online connections to Controller, refer to *Section 6. Online Connections to a Controller* of the *Sysmac Studio Version 1 Operation Manual* (Cat. No. W504).

<p>1 Connect the Ethernet cable to the built-in EtherCAT port (PORT2) on Controller, and connect a USB cable to the peripheral (USB) port. As shown in 5.2. <i>Device Configuration</i>, connect Personal computer and Slave Terminal to Controller.</p>	
<p>2 Turn ON Controller and Unit power supply for Slave Terminal.</p> <p>*The I/O power supply for Slave Terminal remains OFF.</p>	
<p>3 Start Sysmac Studio.</p> <p>*If the User Account Control Dialog Box is displayed at start, make a selection to start Sysmac Studio.</p>	
<p>4 Sysmac Studio starts. Click <b>Connect to Device</b>.</p>	

- 5 The Connect to Device Dialog Box is displayed.  
 Select *Direct connection via USB* in the *Connection type* Field.  
 Uncheck both *Transfer from Device* and *Display the Troubleshooting Dialog Box* in the *Operation after Connection* Field.

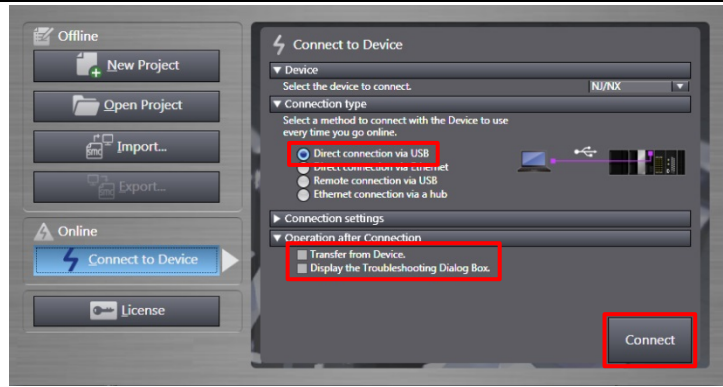

Click **Connect**.

- 6 A confirmation dialog box is displayed. Check the contents and click **OK**.

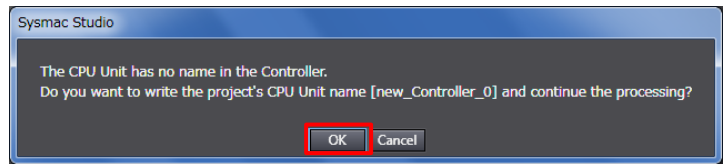

\*The displayed dialog depends on the status of Controller. Check the contents and click on an appropriate button to proceed with the processing.

- 7 The dialog box on the right is displayed. Check the contents and click **OK**.

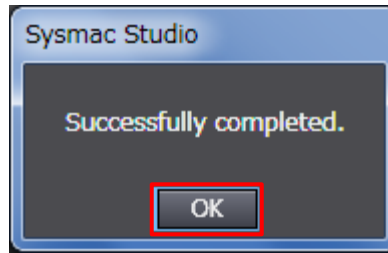

- 8 The Auto Connect Project Dialog Box is displayed online. When an online connection is established, a yellow bar is displayed under the toolbar.

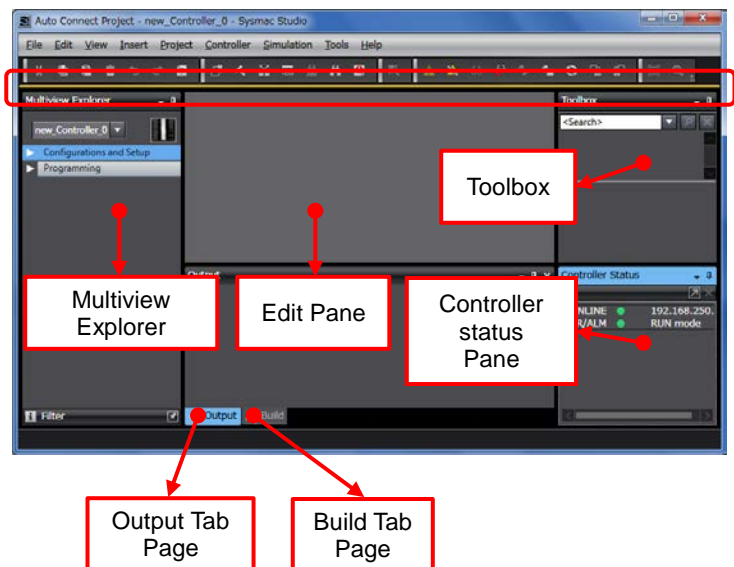

The following panes are displayed in this window.

Left: Multiview Explorer

Top right: Toolbox

Bottom right: Controller Status Pane

Middle top: Edit Pane

The following tabs are displayed in the bottom middle of this window.





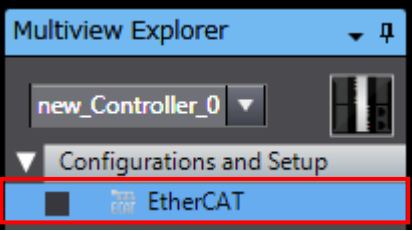
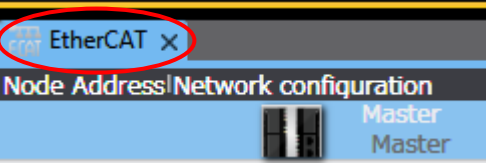
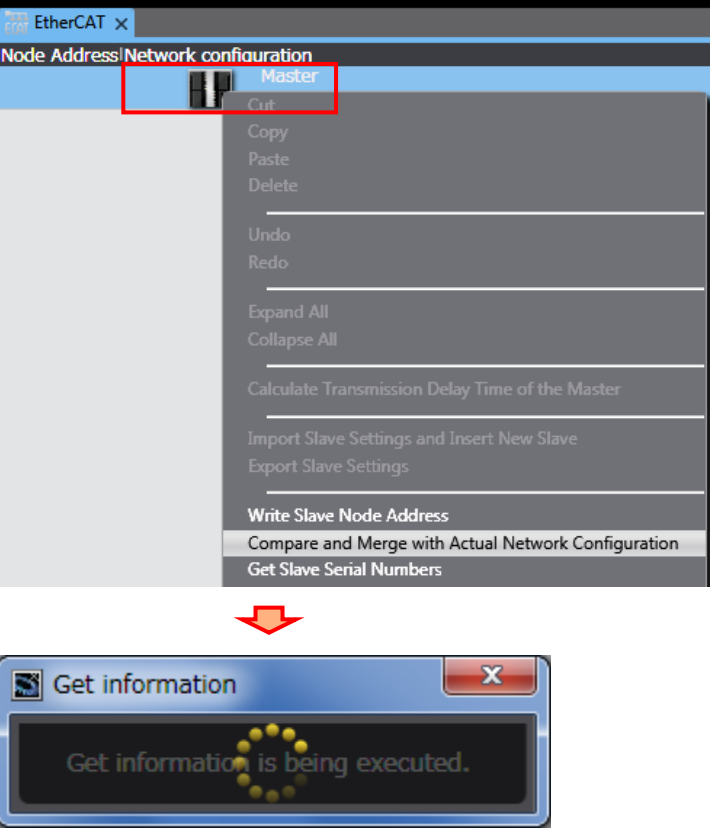
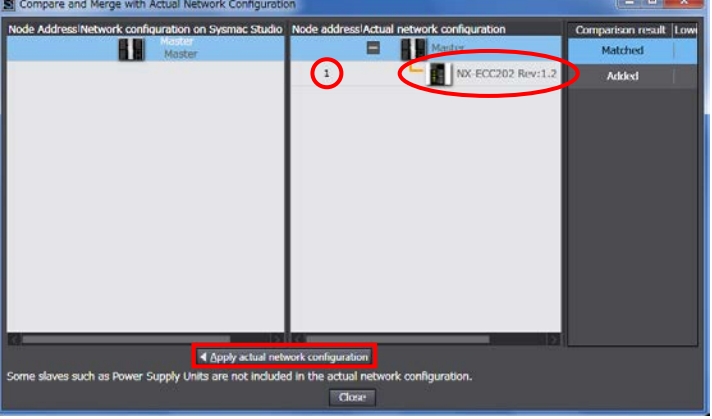

Output Tab Page

Build Tab Page

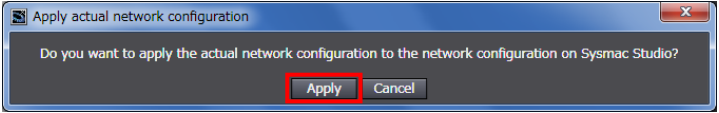
### 7.3.2. Setting up the EtherCAT Network Configuration

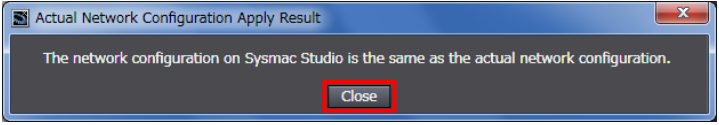
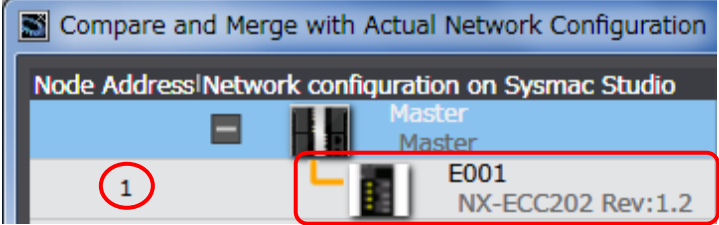
Set up the EtherCAT network configuration.

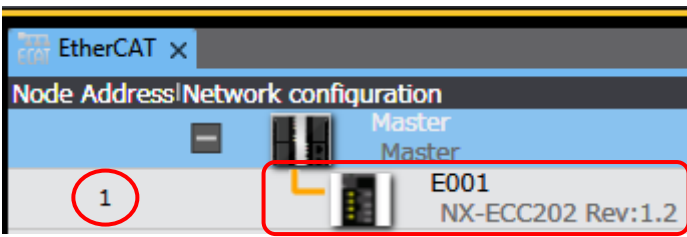
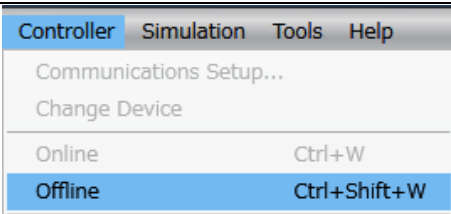
1	Double-click <b>EtherCAT</b> under <b>Configurations and Setup</b> in the Multiview Explorer.	
2	The EtherCAT Tab Page is displayed in the Edit Pane.	
3	Right-click <b>Master</b> on the EtherCAT Tab Page in the Edit Pane and select <b>Compare and Merge with Actual Network Configuration</b> .	 <p data-bbox="274 1361 699 1482">A screen is displayed stating "Get information is being executed".</p>
4	The Compare and Merge with Actual Network Configuration Dialog Box is displayed. Node address 1 and NX-ECC202 Rev:1.2 are added to the Actual network configuration after the comparison.  Click <b>Apply actual network configuration</b> .	

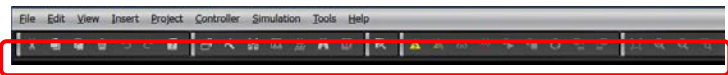
<p>5 A confirmation dialog box is displayed. Check the contents and click <b>Apply</b>.</p> <p>The confirmation dialog box on the right is displayed. Check the contents and click <b>Close</b>.</p>	  
<p>6 As a node address 1 slave, E001 NX-ECC202 Rev:1.2 is added to the Network configuration on Sysmac Studio.</p> <p>Check that the data above is added. Click <b>Close</b>.</p>	 
<p>7 Node address 1 and E001 NX-ECC202 Rev:1.2 are added to the EtherCAT Tab Page in the Edit Pane.</p>	
<p>8 Select <b>Offline</b> from the Controller Menu.</p> <p>The yellow bar under the toolbar disappears.</p>	  

## 7.4. IO-Link Master Unit Setup

Set up IO-Link Master Unit.

### 7.4.1. Parameter Settings

Set the parameters for IO-Link Master Unit.

In this document, the default values are used for the parameter settings of IO-Link Master Unit. Check that IO-Link Mode is set as the communications mode for Port 1 to which Photoelectric Sensor is connected.



#### Additional Information

If you use the functions such as the connected device verification and the backup and restoration of parameter settings in IO-Link devices, refer to the *NX-series IO-Link Master Unit User's Manual* (Cat. No. W567) and the *IO-Link System User's Manual* (Cat. No. W570).

- 1 Select **NX-ECC202 Rev:1.2** on the EtherCAT Tab Page in the Edit Pane. Check that the device name is E001.

\*The device name can be changed as desired. The device name you set is used at the beginning of the device variable name.

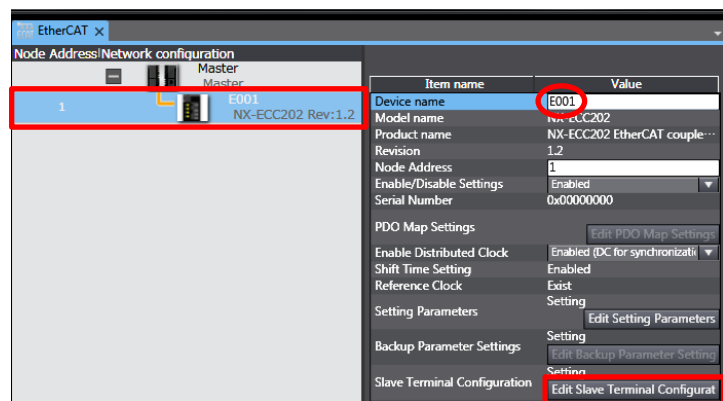

Click **Edit Slave Terminal Configuration**.

- 2 The Node1:NX-ECC202 (E001) Tab Page is displayed. Select the NX Unit number 1 (IO-Link Master Unit). The setting details are displayed on the right side of the tab page. Check that the device name is N1.

\*The device name can be changed as desired. The device name you set is used at the beginning of the device variable name.

Click **Edit Unit Operation Settings**.

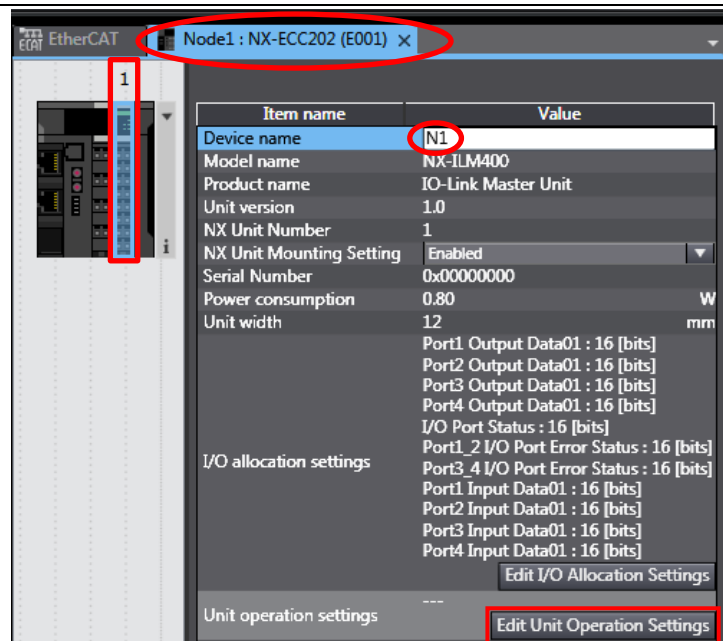

- 3 The Unit1[Node1]:NX-ILM400 (N1)Unit Operation Settings Tab Page is displayed.

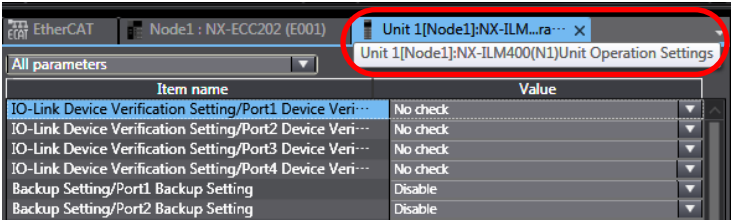

Item name	Value
IO-Link Device Verification Setting/Port1 Device Veri...	No check
IO-Link Device Verification Setting/Port2 Device Veri...	No check
IO-Link Device Verification Setting/Port3 Device Veri...	No check
IO-Link Device Verification Setting/Port4 Device Veri...	No check
Backup Setting/Port1 Backup Setting	Disable
Backup Setting/Port2 Backup Setting	Disable
- 4 Select ▼Port1 - Port1 IO-Link Device Configuration Data from the pull-down list (just above the column "Item name") to narrow down the parameters.

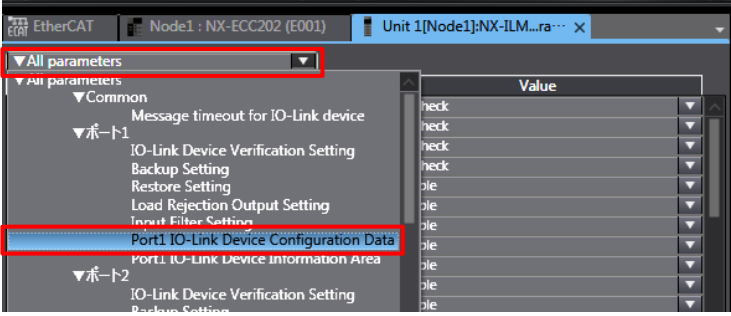
- 5 A list of Port1 IO-Link Device Configuration Data is displayed. Check that IO-Link Mode is selected as the set value of Port1 IO-Link Device Configuration Data/Master Control.

\*If IO-Link Mode is not displayed in the Value Column, select the mode from the pull-down list.

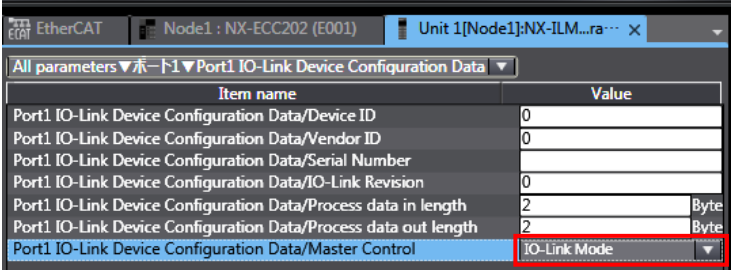

Item name	Value
Port1 IO-Link Device Configuration Data/Device ID	0
Port1 IO-Link Device Configuration Data/Vendor ID	0
Port1 IO-Link Device Configuration Data/Serial Number	
Port1 IO-Link Device Configuration Data/IO-Link Revision	0
Port1 IO-Link Device Configuration Data/Process data in length	2 Byte
Port1 IO-Link Device Configuration Data/Process data out length	2 Byte
Port1 IO-Link Device Configuration Data/Master Control	IO-Link Mode



### 7.4.2. I/O Allocation Settings

Set the I/O allocations for IO-Link Master Unit.

As the default values are used for the I/O allocations in this document, the I/O allocation settings are made without editing any of the values.



#### Additional Information

To save the I/O data size for unused ports, delete the I/O entries for the unused ports from the I/O allocation settings.

The Edit I/O Allocation Settings Pane is displayed by clicking **Edit I/O Allocation Settings** shown on the right.

For information on how to edit, refer to the *IO-Link System User's Manual* (Cat. No. W570).

The screenshot shows the EtherCAT software interface. The top bar displays 'Node1 : NX-ECC202 (E001)'. The main area is divided into two panes. The left pane shows a tree view with '1' highlighted. The right pane displays the configuration for the selected unit. The 'I/O allocation settings' section is expanded, showing a list of I/O ports and their data sizes. The 'Edit I/O Allocation Settings' button is highlighted with a red box.

Item name	Value
Device name	N1
Model name	NX-ILM400
Product name	IO-Link Master Unit
Unit version	1.0
NX Unit Number	1
NX Unit Mounting Setting	Enabled
Serial Number	0x00000000
Power consumption	0.80 W
Unit width	12 mm
I/O allocation settings	
Port1 Output Data01	: 16 [bits]
Port2 Output Data01	: 16 [bits]
Port3 Output Data01	: 16 [bits]
Port4 Output Data01	: 16 [bits]
I/O Port Status	: 16 [bits]
Port1_2 I/O Port Error Status	: 16 [bits]
Port3_4 I/O Port Error Status	: 16 [bits]
Port1 Input Data01	: 16 [bits]
Port2 Input Data01	: 16 [bits]
Port3 Input Data01	: 16 [bits]
Port4 Input Data01	: 16 [bits]
Unit operation settings	

## 7.5. Controller Setup

Set up Controller.

### 7.5.1. Setting the Device Variables

Set the device variables to use for Slave Terminal.

- 1 Double-click **I/O Map** under **Configurations and Setup** in the Multiview Explorer.

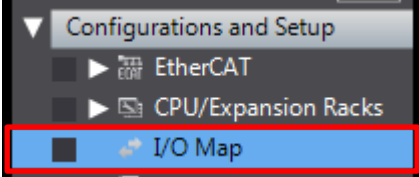

- 2 The I/O Map Tab Page is displayed in the Edit Pane. Check that Node1 is displayed in the *Position* Column and that the previously added Slave Terminal is displayed in the *Port* Column.

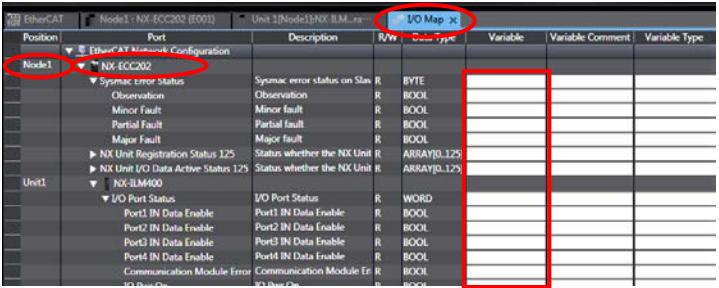
\*To manually set a variable name for Slave Terminal, click an entry cell in the *Variable* Column and enter a name.

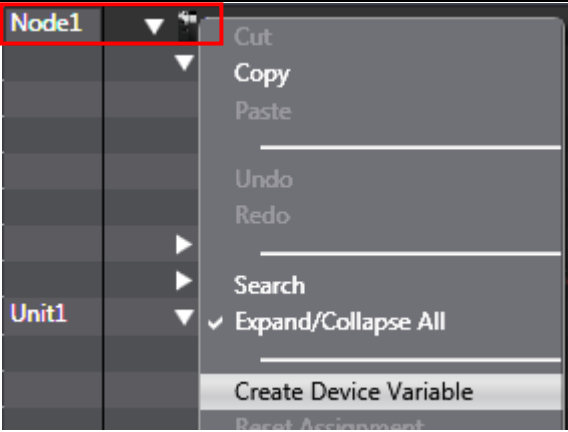

Position	Port	Description	R/W	Data Type	Variable	Variable Comment	Variable Type
Node1	EtherCAT Network Configuration						
	NX-ECC202						
		Synmac error status	Synmac error status on Slave	R	BYTE		
		Observation	Observation	R	BOOL		
		Minor Fault	Minor fault	R	BOOL		
Unit1	NX-ILM400						
		I/O Port Status	I/O Port Status	R	WORD		
		Port1 IN Data Enable	Port1 IN Data Enable	R	BOOL		
		Port2 IN Data Enable	Port2 IN Data Enable	R	BOOL		
		Port3 IN Data Enable	Port3 IN Data Enable	R	BOOL		
		Port4 IN Data Enable	Port4 IN Data Enable	R	BOOL		
		Communication Module Error	Communication Module Error	R	BOOL		
		NX Unit Registration Status 125	Status whether the NX Unit is	R	ARRAY[0..125]		
		NX Unit I/O Data Active Status 125	Status whether the NX Unit I/O	R	ARRAY[0..125]		
- 3 Right-click **Node1** and select **Create Device Variable**.

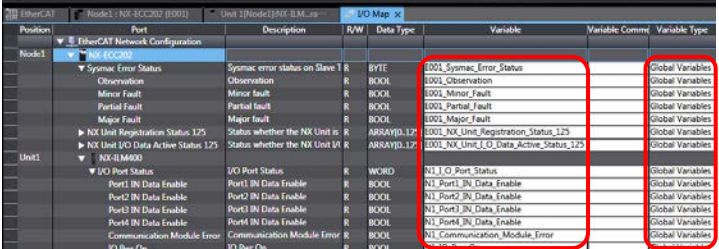
- 4 The variable names and types are set.



Position	Port	Description	R/W	Data Type	Variable	Variable Comment	Variable Type
Node1	EtherCAT Network Configuration						
	NX-ECC202						
		Synmac error status	Synmac error status on Slave 1	R	BYTE	0001_Synmac_Error_Status	Global Variables
		Observation	Observation	R	BOOL	0001_Observation	Global Variables
		Minor Fault	Minor fault	R	BOOL	0001_Minor_Fault	Global Variables
Unit1	NX-ILM400						
		I/O Port Status	I/O Port Status	R	WORD	0001_Minor_Fault	Global Variables
		Port1 IN Data Enable	Port1 IN Data Enable	R	BOOL	0001_Port1_IN_Data_Enable	Global Variables
		Port2 IN Data Enable	Port2 IN Data Enable	R	BOOL	0001_Port2_IN_Data_Enable	Global Variables
		Port3 IN Data Enable	Port3 IN Data Enable	R	BOOL	0001_Port3_IN_Data_Enable	Global Variables
		Port4 IN Data Enable	Port4 IN Data Enable	R	BOOL	0001_Port4_IN_Data_Enable	Global Variables
		Communication Module Error	Communication Module Error	R	BOOL	0001_Communication_Module_Error	Global Variables
		NX Unit Registration Status 125	Status whether the NX Unit is	R	ARRAY[0..125]	0001_NX_Unit_Registration_Status_125	Global Variables
		NX Unit I/O Data Active Status 125	Status whether the NX Unit I/O	R	ARRAY[0..125]	0001_NX_Unit_I/O_Data_Active_Status_125	Global Variables



### **Additional Information**

---

The device variables are named automatically from a combination of the device names and the port names. For slave units, the default device names are "E" followed by a serial number that starts from 001. For NX Units, the default device names are "N" followed by a serial number that starts from 1.

---



### **Additional Information**

---

In this document, device variables are automatically named for a unit (a slave). Device variables can also be manually named for ports.

---

7.5.2. Transferring the Project Data

Connect online with Sysmac Studio and transfer the project data to Controller.

**⚠ WARNING**

When you transfer a user program, configuration data, setup data, device variables, or values in memory used for CJ-series Units from Sysmac Studio, the devices or machines may perform unexpected operation regardless of the operating mode of CPU Unit.

Always confirm safety at the destination node before you transfer the project data.



**⚠ Caution**

After you transfer the project data, CPU Unit restarts, and communications with the slaves is cut off. During the period, the slave outputs behave according to the slave settings. The time that communications is cut off depends on the EtherCAT network configuration.

Before you transfer the project data, confirm that the slave settings will not adversely affect the device.



**⚠ Caution**

The Slave Unit will be reset after performing the synchronization in step 7 and subsequent steps, and the device may perform unexpected operation.

Always confirm safety before you perform the synchronization.

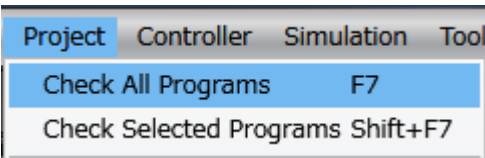
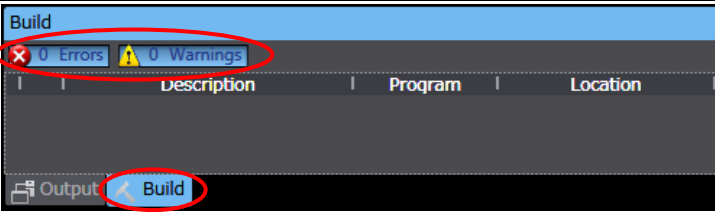
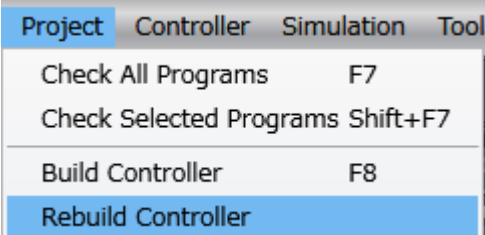

1	Select <b>Check All Programs</b> from the Project Menu.	
2	The Build Tab Page is displayed. Check that "0 Errors" and "0 Warnings" are displayed.	
3	Select <b>Rebuild Controller</b> from the Project Menu.	

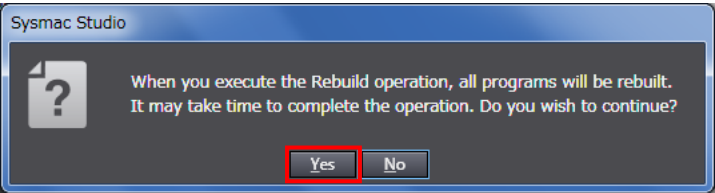
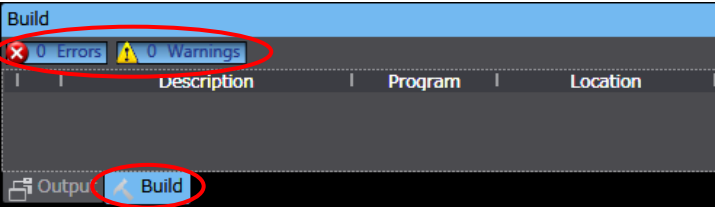
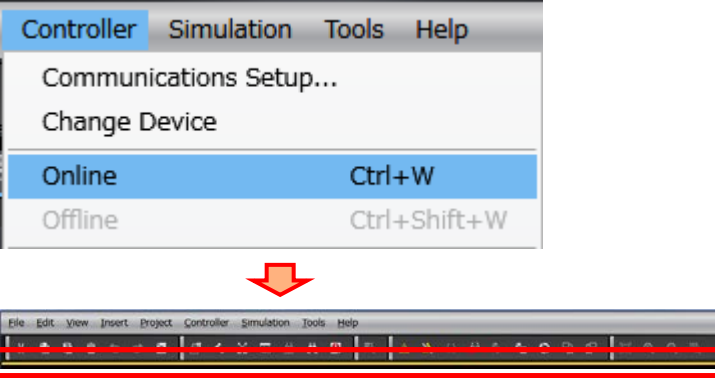
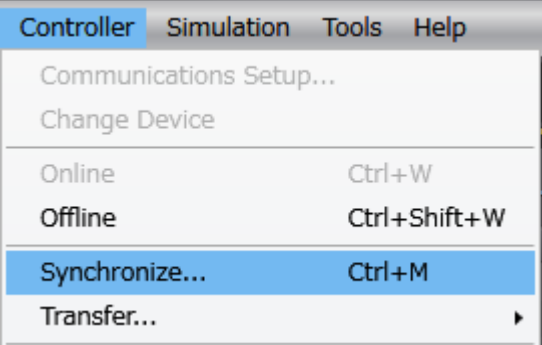
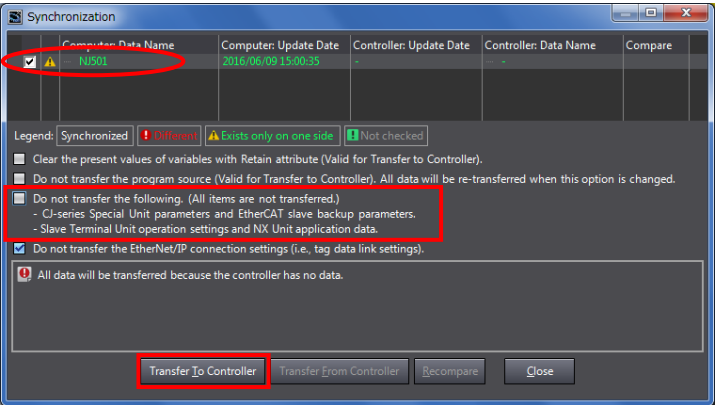
<p>4 A confirmation dialog box is displayed. Confirm that there is no problem, and click <b>Yes</b>.</p>	
<p>5 Check that "0 Errors" and "0 Warnings" are displayed on the Build Tab Page.</p>	
<p>6 Select <b>Online</b> from the Controller Menu.</p> <p>When an online connection is established, a yellow bar is displayed under the toolbar.</p>	
<p>7 Select <b>Synchronize</b> from the Controller Menu.</p>	
<p>8 The Synchronization Dialog Box is displayed.</p> <p>Check that the data to transfer (NJ501 in the right dialog box) is selected.</p> <p>Uncheck <i>Do not transfer the following. (All items are not transferred.)</i> to make "Slave Terminal Unit operation settings" transfer.</p> <p>Click <b>Transfer To Controller</b>.</p> <p>*After executing Transfer To Controller, the Sysmac Studio data is transferred to Controller, and the data is synchronized.</p>	

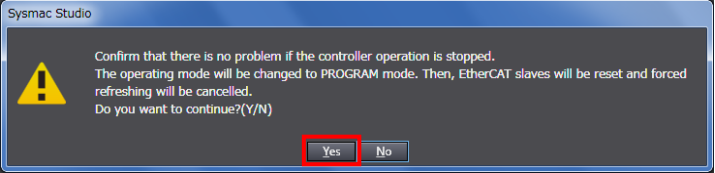
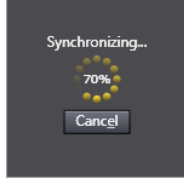
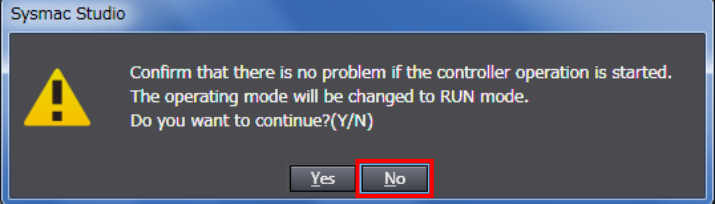
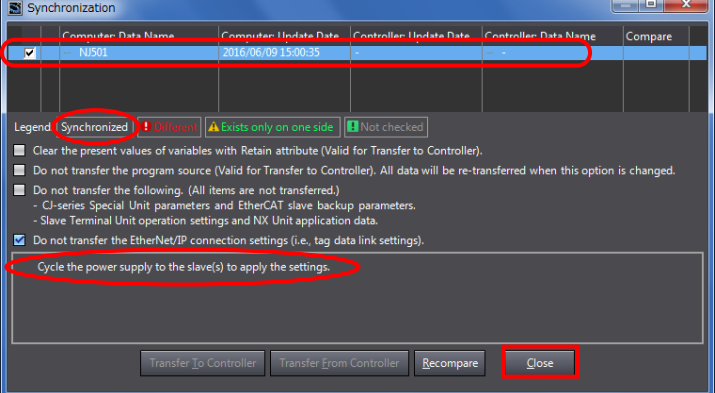
<p>9 A confirmation dialog box is displayed. Confirm that there is no problem, and click <b>Yes</b>.</p> <p>A screen is displayed stating "Synchronizing".</p> <p>A confirmation dialog box is displayed. Confirm that there is no problem, and click <b>No</b>.</p> <p>*Do not return to RUN mode.</p>	  										
<p>10 As shown in the figure on the right, the font color that is used to display the text of synchronized data changes to the same color as the one used to specify "Synchronized". Check that a message is displayed stating "Cycle the power supply to the slave(s) to apply the settings". Click <b>Close</b>.</p> <p>*When the Sysmac Studio project data coincides with the Controller data, the synchronized data will have the same font color as the one used to specify "Synchronized".</p> <p>*If the synchronization fails, check the wiring and repeat from step 1.</p>	 <table border="1" data-bbox="710 851 1428 918"> <thead> <tr> <th>Computer Data Name</th> <th>Computer Update Date</th> <th>Controller Update Date</th> <th>Controller Data Name</th> <th>Compare</th> </tr> </thead> <tbody> <tr> <td><input checked="" type="checkbox"/> NJ501</td> <td>2016/06/09 15:00:35</td> <td>-</td> <td>-</td> <td></td> </tr> </tbody> </table>	Computer Data Name	Computer Update Date	Controller Update Date	Controller Data Name	Compare	<input checked="" type="checkbox"/> NJ501	2016/06/09 15:00:35	-	-	
Computer Data Name	Computer Update Date	Controller Update Date	Controller Data Name	Compare							
<input checked="" type="checkbox"/> NJ501	2016/06/09 15:00:35	-	-								
<p>11 To reflect the settings, turn OFF Unit power supply for Slave Terminal, then turn it back ON.</p>											

12 Check that the LED status is as shown below, which indicates that Slave Terminal is able to communicate.

- RUN : Not lit
- ERR : Not lit
- TS : Green flashing
- L/A IN : Green flickering
- L/A OUT: Not lit

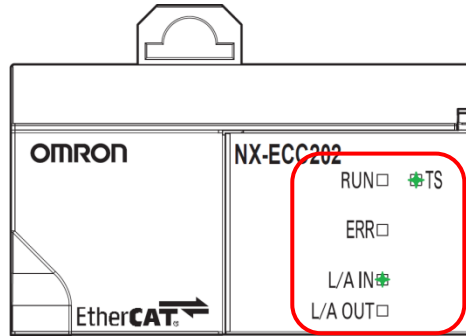

13 The LED status of Controller is as shown below when an error occurs in EtherCAT communications due to the temporary interruption of Unit power supply for Slave Terminal.

- NET RUN : Not lit
- NET ERR : Red flashing
- LINK/ACT : Yellow flashing

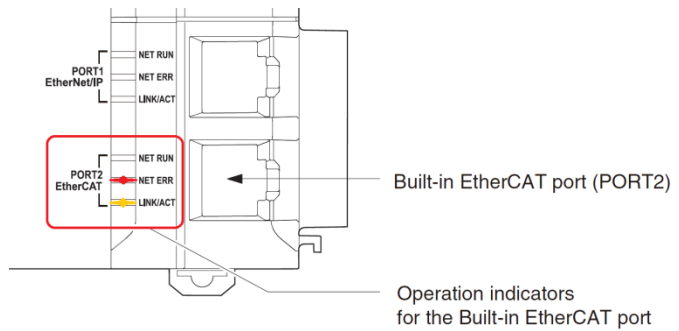

14 Select **Troubleshooting** from the Tools Menu.

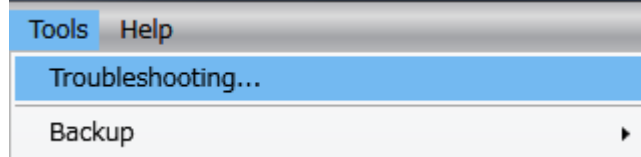

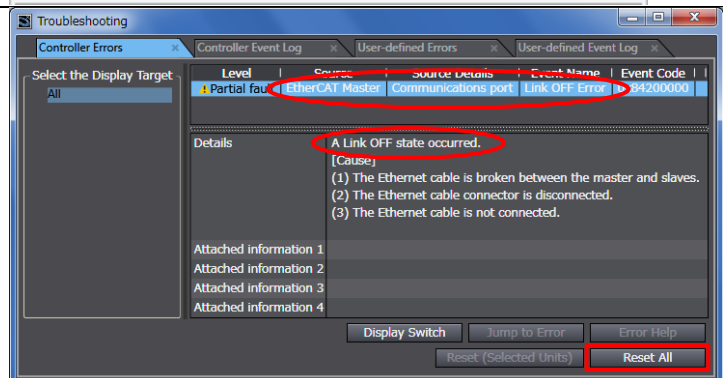

15 The Troubleshooting Dialog Box is displayed. Check that a Link OFF Error occurs as shown in the figure on the right.

Click **Reset All**.

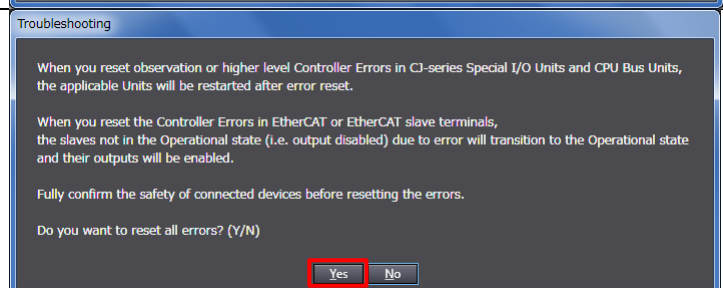

16 A confirmation dialog box is displayed. Check the contents and click **Yes**.



- 17 Check that the error is not displayed. Click  at the top right of the Troubleshooting Dialog Box to close.

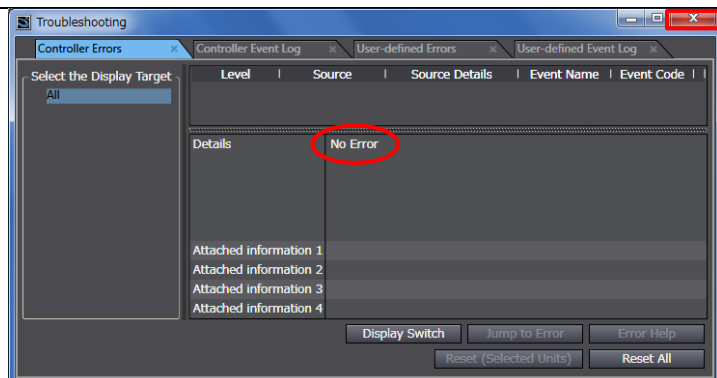

- 18 Turn ON I/O power supply for Slave Terminal.



## 7.6. IO-Link Communication Status Check

Confirm that cyclic communications in the IO-Link system performs normally.

### 7.6.1. Checking the Connection Status

Check the connection status of each device.

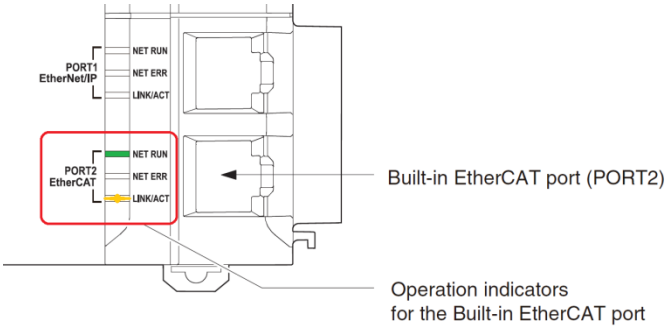
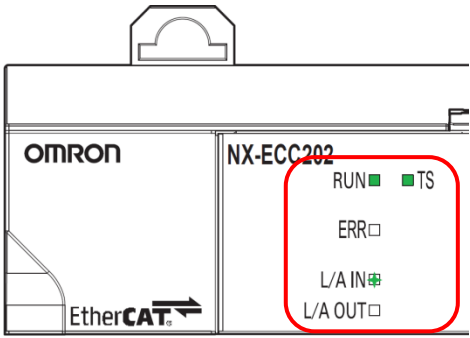
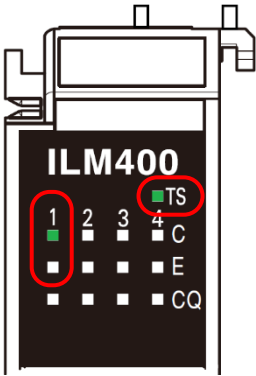
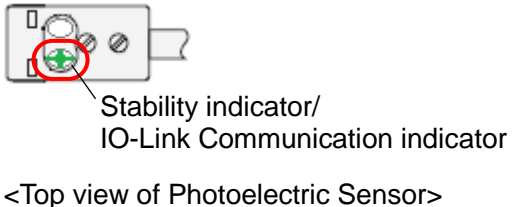
<p><b>1</b> Check with LED indicators on Controller that PDO communications via EtherCAT performs normally.</p> <p>The LED indicators in normal status are as follows:</p> <ul style="list-style-type: none"> <li>NET RUN: Green lit</li> <li>NET ERR: Not lit</li> <li>LINK/ACT: Yellow flashing</li> </ul>	
<p><b>2</b> Check the LED indicators on EtherCAT Coupler Unit.</p> <p>The LED indicators in normal status are as follows:</p> <ul style="list-style-type: none"> <li>RUN: Green lit</li> <li>TS: Green lit</li> <li>ERR: Not lit</li> <li>L/A IN: Green flickering</li> <li>L/A OUT: Not lit</li> </ul>	
<p><b>3</b> Check the LED indicators on IO-Link Master Unit.</p> <p>The LED indicators in normal status are as follows:</p> <ul style="list-style-type: none"> <li>TS: Green lit</li> <li>1-C: Green lit</li> <li>1-E: Not lit</li> </ul>	
<p><b>4</b> Check the LED indicator on Photoelectric Sensor.</p> <p>The LED indicator in normal status is as follows:</p> <ul style="list-style-type: none"> <li>Stability indicator / IO-Link Communication indicator: Green flashing</li> </ul>	

7.6.2. Checking the Receive Data

Check that the correct data are received.

Install CX-ConfiguratorFDT on Personal computer beforehand.

 **Caution**

If you wire the I/O in the state where the devices are powered ON, doing so may cause damage to the devices.

Always read and follow the information provided in all safety precautions in the manuals for each device to be wired.



 **Caution**

If you change the variable values on a Watch Tab Page when Sysmac Studio is online with CPU Unit, the devices connected to the output unit may operate regardless of the operating mode of CPU Unit.

Always ensure safety before you change the variable values on a Watch Tab Page when Sysmac Studio is online with CPU Unit

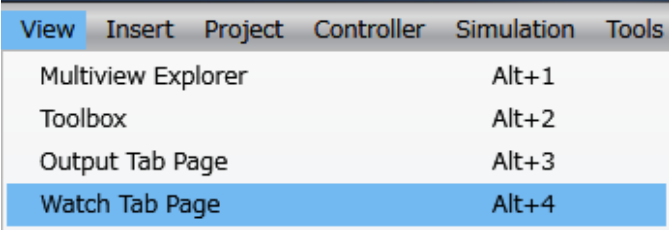
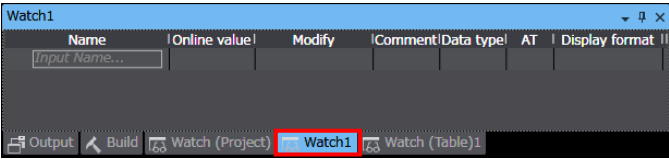
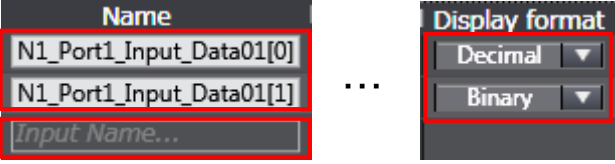
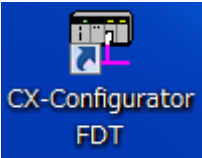

- |   |  |  |
|---|--|--|
| 1 | Select <b>Watch Tab Page</b> from the View Menu.   |  |
| 2 | Select the <b>Watch1</b> Tab.  |  |
| 3 | Click <i>Input Name</i> and enter the following variable names for monitoring. Select the display format of each variable as shown below.<br>Name: <i>N1_Port1_Input_Data01[0]</i><br>Display format: <b>Decimal</b><br>Name: <i>N1_Port1_Input_Data01[1]</i><br>Display format: <b>Binary</b> |  |
| 4 | Start CX-ConfiguratorFDT.  |   |

- 5 CX-ConfiguratorFDT starts. Right-click **MyNetwork** in the Network View and select **Add** from the menu.

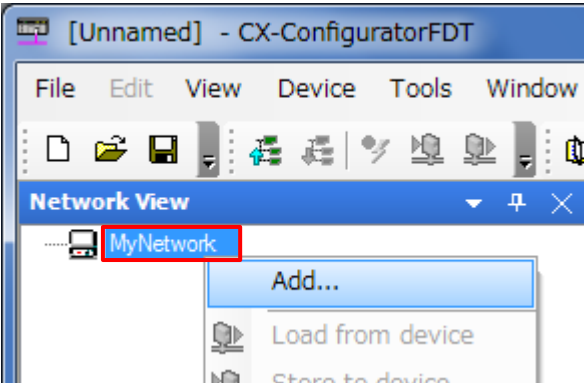

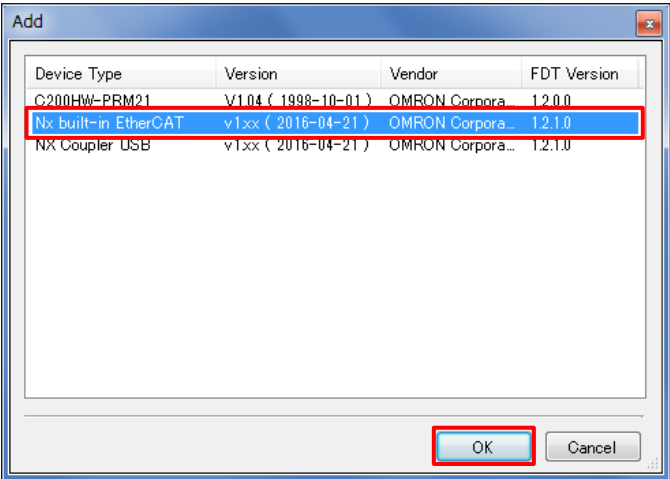
  
- 6 The Add Dialog Box is displayed. Select *Nx built-in EtherCAT*. Click **Yes**.

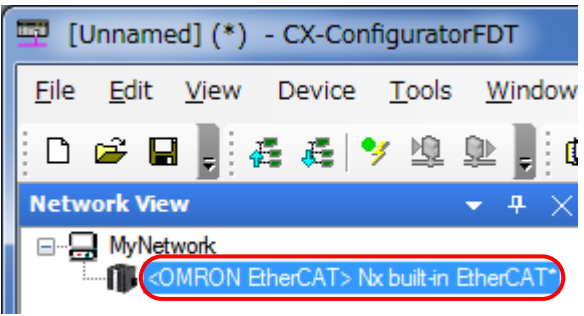

Device Type	Version	Vendor	FDT Version
C200HW-PRM21	V1.04 ( 1998-10-01 )	OMRON Corpora...	12.0.0
Nx built-in EtherCAT	v1.xx ( 2016-04-21 )	OMRON Corpora...	12.1.0
NX Coupler USB	v1.xx ( 2016-04-21 )	OMRON Corpora...	12.1.0
  
- 7 Check that <OMRON EtherCAT> Nx built-in EtherCAT is added under MyNetwork in the Network View.

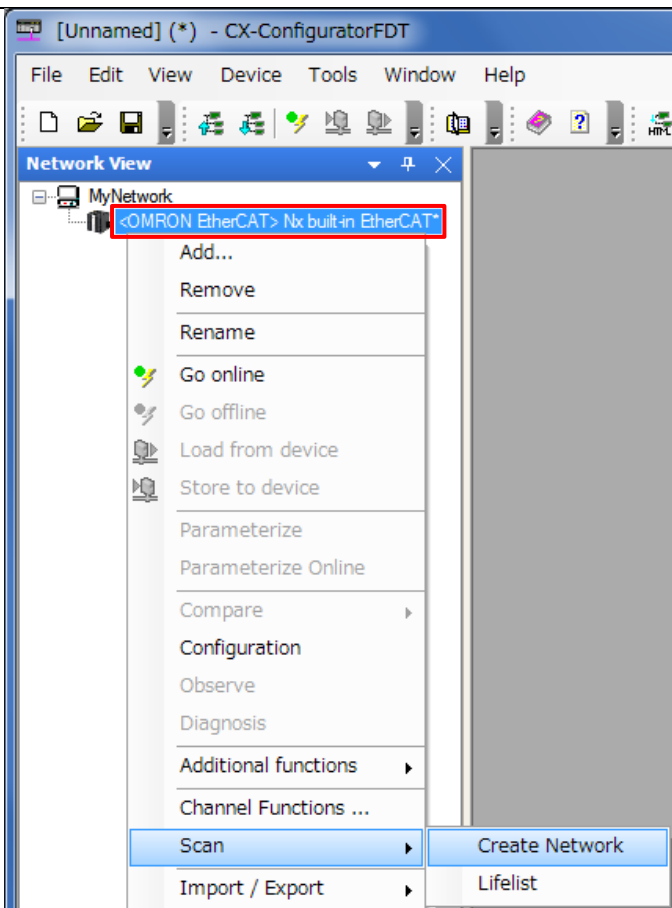

- 8 Right-click <OMRON EtherCAT> Nx built-in EtherCAT and select **Scan - Create Network** from the menu.



- 9 The Lifelist Dialog Box is displayed after completing the network scan. Check that <OMRON EtherCAT:1> NX-ECC Coupler is added under Nx built-in EtherCAT. Click **Add All and Continue**.

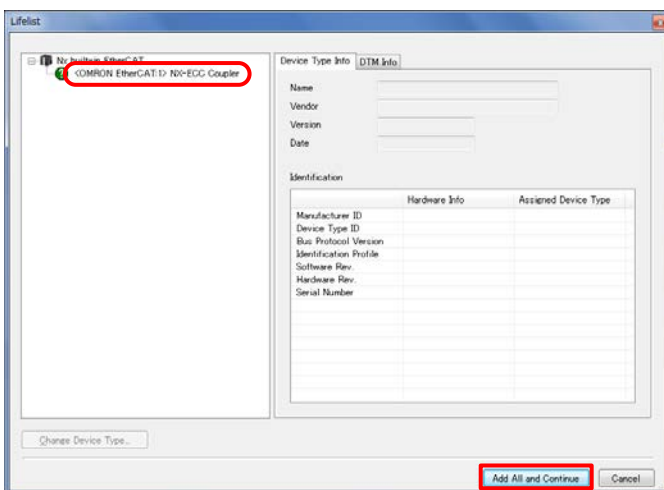
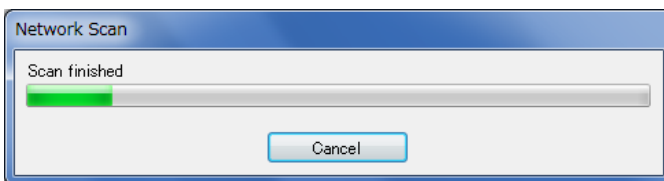

- 10 The Lifestlist Dialog Box is displayed again after completing the network scan.  
 Check that <IO-Link Port\_1:NOT\_APPLICABLE>  
 E3Z-D-IL3 IODD1.1 is added under  
 NX-ILM400.  
 Click **Add All and Continue**.

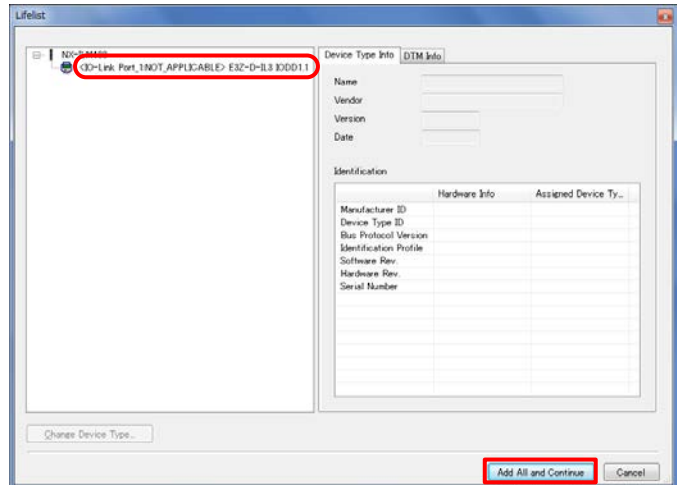
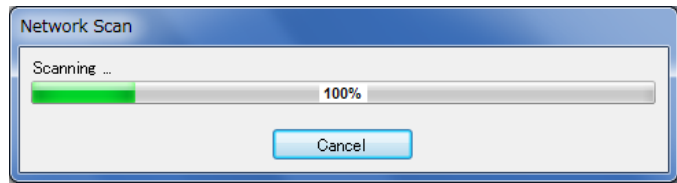

- 11 Check that the network configuration is created in the Network View as shown on the right.

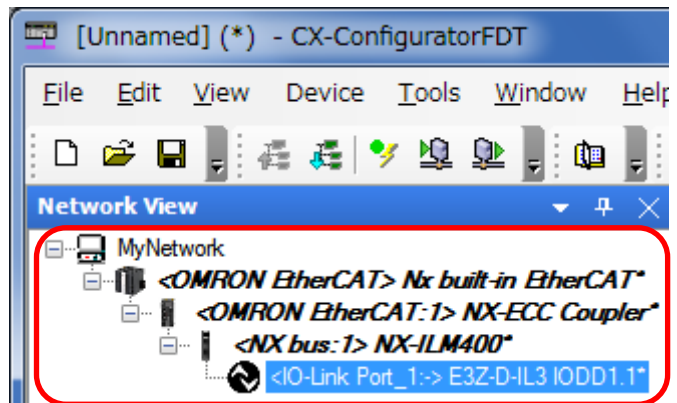

- 12 Right-click <IO-Link Port\_1:->  
 E3Z-D-IL3 IODD1.1 and select **Go online**  
 from the menu.

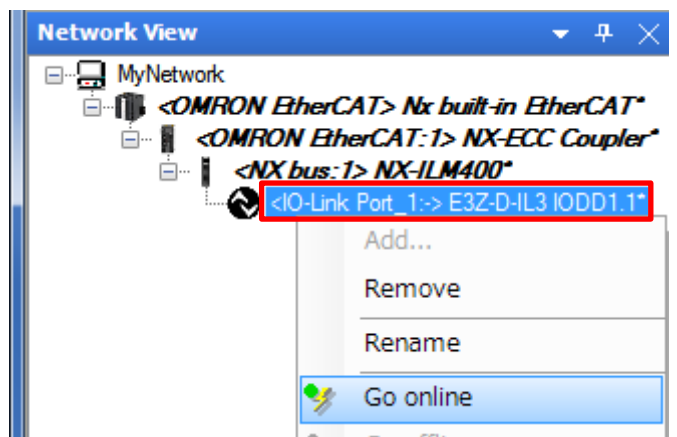

13 Check that Photoelectric Sensor is connected online.  
 Right-click <IO-Link Port\_1:-> E3Z-D-IL3 IODD1.1 and select **Configuration** from the menu.

\*When <IO-Link Port\_1:-> E3Z-D-IL3 IODD1.1 is displayed in bold italic font, Photoelectric Sensor is connected online.

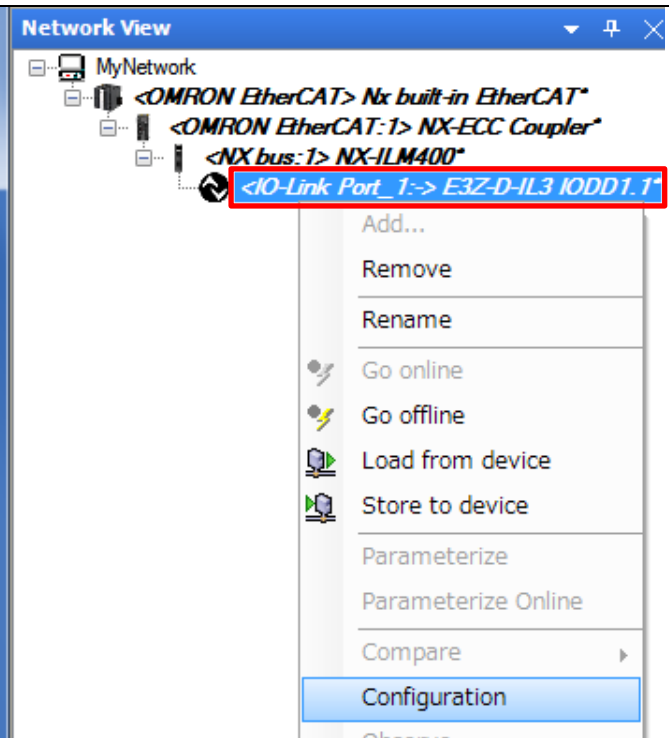

14 The <IO-Link Port\_1:-> E3Z-D-IL3 IODD1.1 - Configuration Tab Page is displayed.

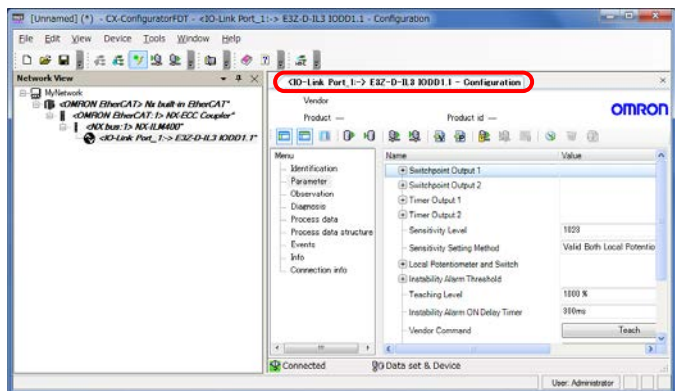

15 Select **Observation** listed under Menu on the <IO-Link Port\_1:-> E3Z-D-IL3 IODD1.1 - Configuration Tab Page.  
 If Process Data In on the right side of the tab page is not expanded, click the + Button of Process Data In to expand.

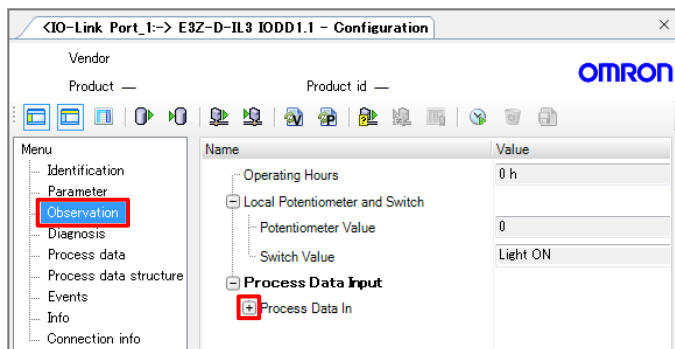

16 Click the  icon (Enable or disable cyclic read from device for dynamic variables) on the <IO-Link Port\_1-> E3Z-D-IL3 IODD1.1 - Configuration Tab Page.  
The present values of the process data for Photoelectric Sensor are displayed in the *Value* Column.

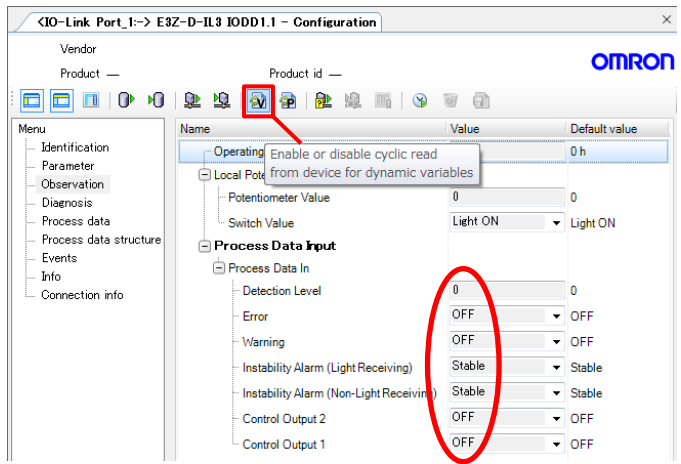

17 Check that Operation mode switch on Photoelectric Sensor is set to Light ON (factory setting). Make sure that there is no sensing object in front of Photoelectric Sensor and that Operation indicator is not lit.

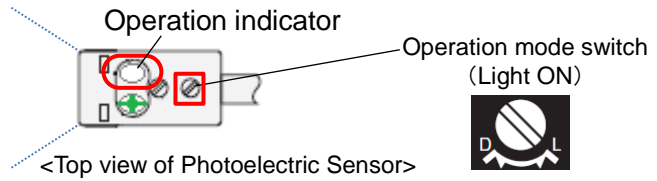

18 Check that the values of Photoelectric Sensor in CX-ConfiguratorFDT are as shown below.

- Detection Level: 3
- Control Output 2: OFF
- Control Output 1: OFF

\*The value of the detection level differs depending on the environmental settings of Photoelectric Sensor.

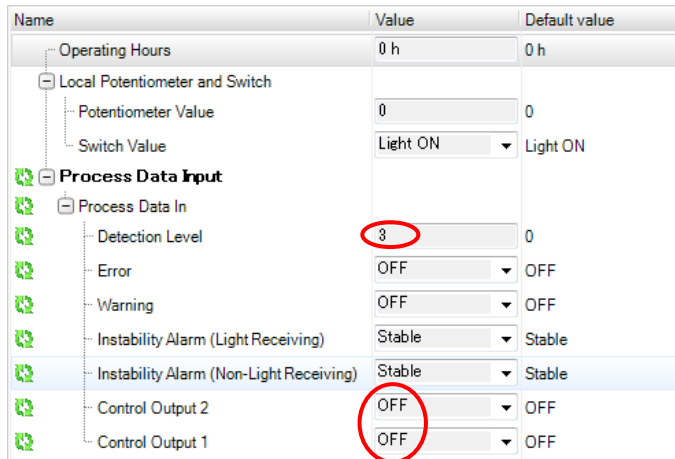

19 Check that the online values on the Watch Tab Page of Sysmac Studio are as shown below.

*N1\_Port1\_Input\_Data01[0]*  
: 3  
*N1\_Port1\_Input\_Data01[1]*  
: 0000 0000 (Bits 0 and 1 are 0.)

Name	Online value
<i>N1_Port1_Input_Data01[0]</i>	3
<i>N1_Port1_Input_Data01[1]</i>	0000 0000

\*For details on each of the variables, refer to 6.4. *Device Variables*.

\*You can check that the monitor output (Detection Level) of Port 1 is 3 and that the control outputs 1 and 2 are OFF; these values are the same as the ones described in step 18.

20 Place Sensing object in front of Photoelectric Sensor and check that Operation indicator is lit in orange.

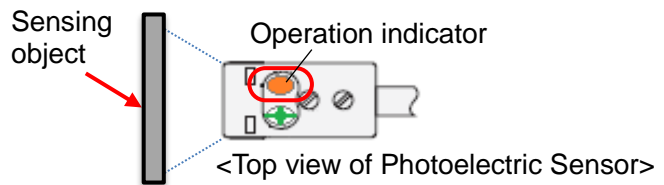

21 Check that the values of Photoelectric Sensor in CX-ConfiguratorFDT are as shown below.

Detection Level: 255  
Control Output 2: ON  
Control Output 1: ON

Name	Value	Default value
Operating Hours	0 h	0 h
Local Potentiometer and Switch		
Potentiometer Value	0	0
Switch Value	Light ON	Light ON
<b>Process Data Input</b>		
Process Data In		
Detection Level	255	0
Error	OFF	OFF
Warning	OFF	OFF
Instability Alarm (Light Receiving)	Stable	Stable
Instability Alarm (Non-Light Receiving)	Stable	Stable
Control Output 2	ON	OFF
Control Output 1	ON	OFF

\*The value of the detection level differs depending on the environmental settings of Photoelectric Sensor.



22 Check that the online values on the Watch Tab Page of Sysmac Studio are as shown below.

*N1\_Port1\_Input\_Data01[0]*

: 255

*N1\_Port1\_Input\_Data01[1]*

: 0000 0011 (Bits 0 and 1 are 1.)

Name	Online value
N1_Port1_Input_Data01[0]	255
N1_Port1_Input_Data01[1]	0000 0011

\*For details on each of the variables, refer to 6.4. *Device Variables*.

\*You can check that the monitor output (Detection Level) of Port 1 is 255 and that the control outputs 1 and 2 are ON; these values are the same as the ones described in step 21.

## 8. Initialization method

The setting procedures in this document are based on the factory default settings. Some settings may not be applicable unless you use the devices with the factory default settings.

### 8.1. Initializing Controller

To initialize the Controller settings, it is necessary to initialize CPU Unit. Change the operating mode of Controller to PROGRAM mode and select **Clear All Memory** from the Controller Menu in Sysmac Studio. The Clear All Memory Dialog Box is displayed. Check the contents and click **OK**.

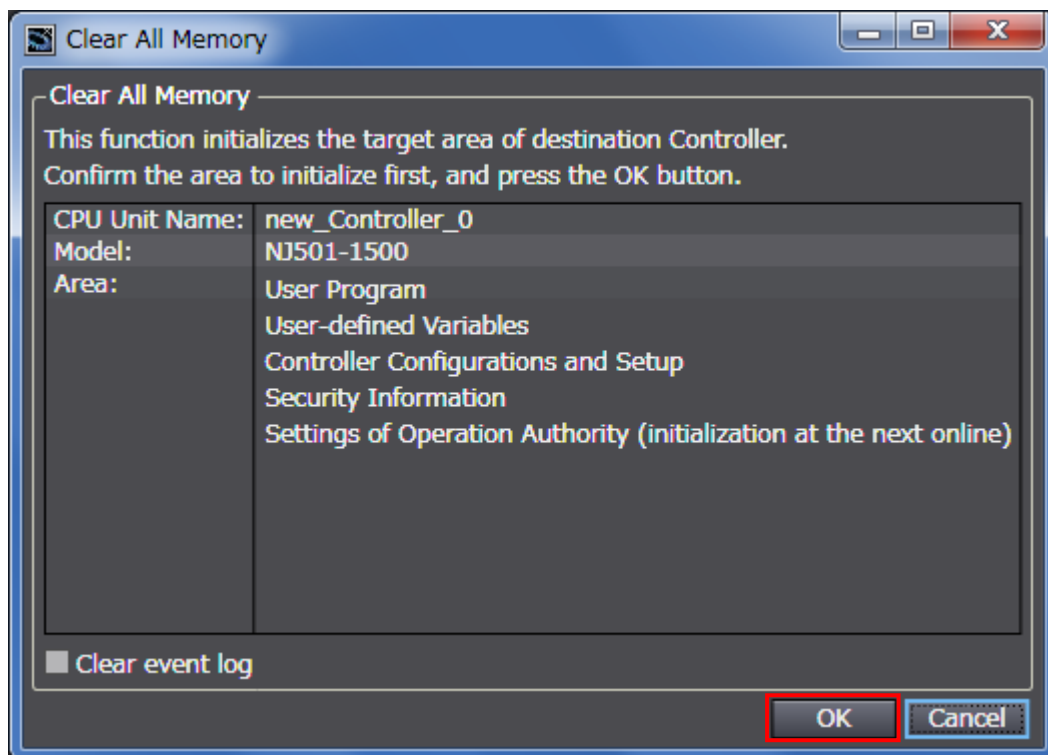

### 8.2. Initializing Slave Terminal

To initialize the Slave Terminal settings, connect Slave Terminal directly to Personal computer on which Sysmac Studio runs.

- (1) Connect the USB cable to the peripheral USB port on EtherCAT Coupler unit.

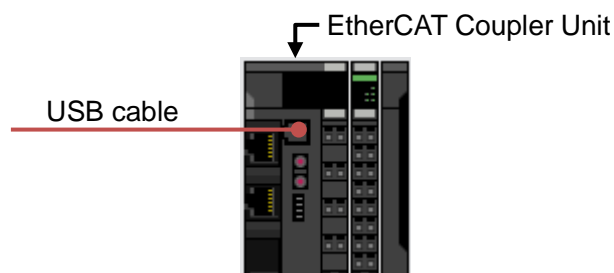

(2) Select **NX-ECC202** on the EtherCAT Tab Page in the Edit Pane.

Click **Edit Slave Terminal Configuration** for the value of Slave Terminal Configuration.

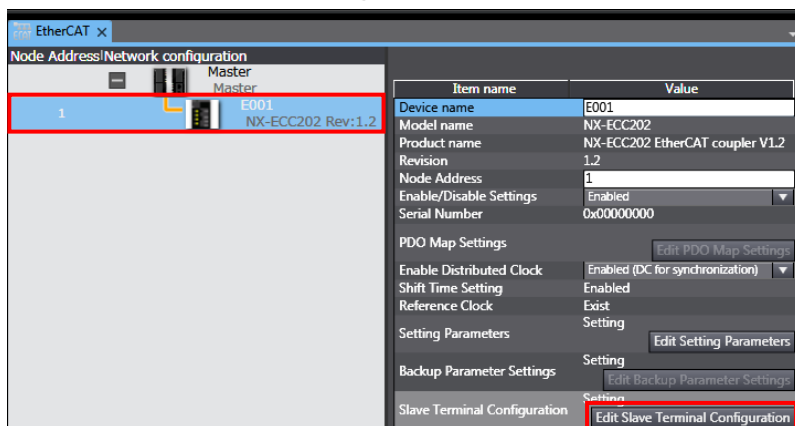

(3) The connected Slave Terminal configuration is displayed. Click **Online**.

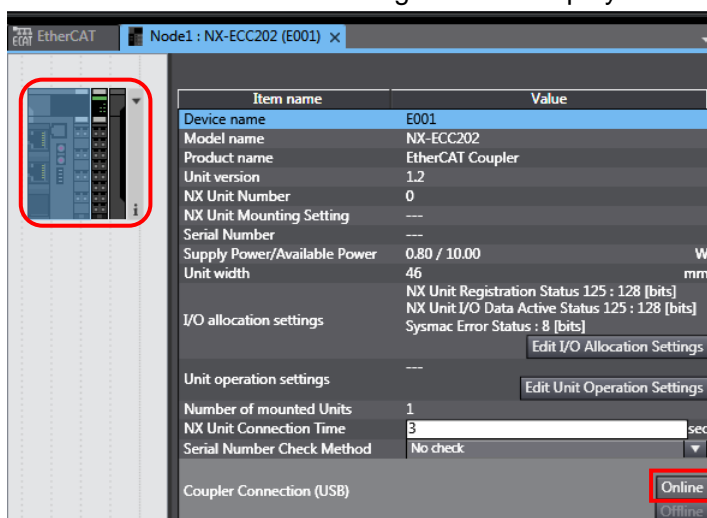

(4) Right-click **Unit 0** (EtherCAT Coupler Unit) after checking the online connection.

Select **Clear All Memory** from the menu.

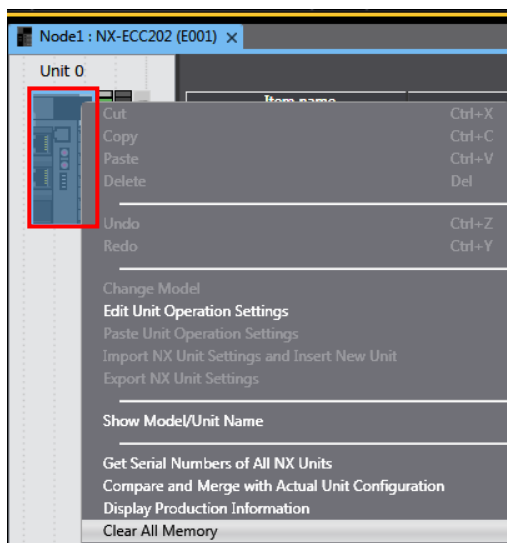

- (5) The Clear All Memory for Coupler Dialog Box is displayed. Check that Coupler + NX Units is selected. Click **Execute**.

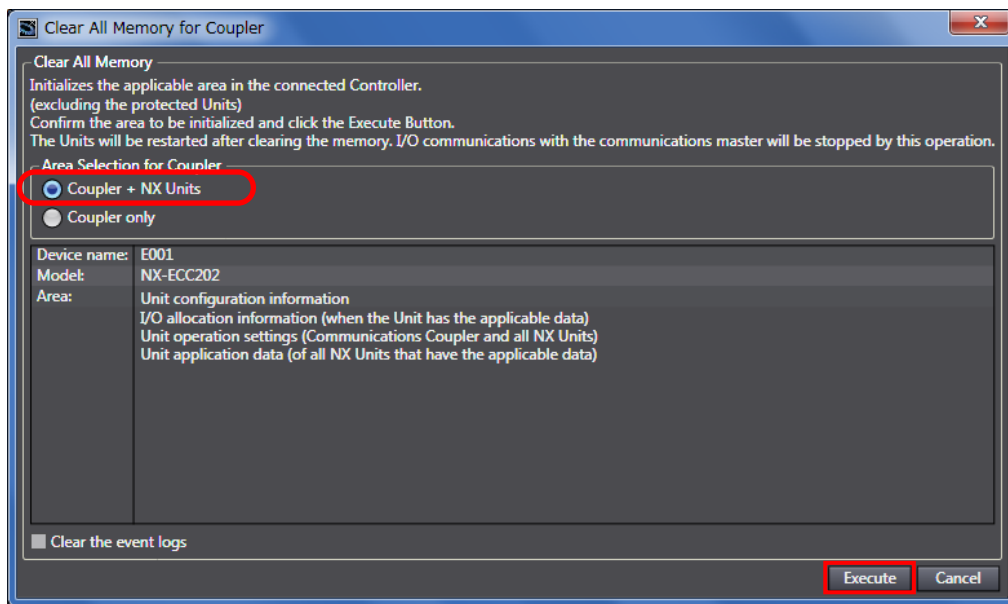

### Precautions for Correct Use

In the initialization of Slave Terminal, the backup data for the IO-Link devices that is stored in IO-Link Master Unit is not cleared. If you need to clear the backup data stored in IO-Link Master Unit, refer to *Clearing Backup Data* in 7-4-2 *Backing Up Settings* of the *IO-Link System User's Manual* (Cat. No. W570) to clear the backup data.

## 9. Revision History

Revision code	Date of revision	Description of revision
01	July 5, 2016	First edition

**OMRON Corporation Industrial Automation Company**

Tokyo, JAPAN

Contact: [www.ia.omron.com](http://www.ia.omron.com)

**Regional Headquarters**

**OMRON EUROPE B.V.**

Wegalaan 67-69, 2132 JD Hoofddorp  
The Netherlands  
Tel: (31)2356-81-300/Fax: (31)2356-81-388

**OMRON ELECTRONICS LLC**

2895 Greenspoint Parkway, Suite 200  
Hoffman Estates, IL 60169 U.S.A  
Tel: (1) 847-843-7900/Fax: (1) 847-843-7787

**OMRON ASIA PACIFIC PTE. LTD.**

No. 438A Alexandra Road # 05-05/08 (Lobby 2),  
Alexandra Technopark,  
Singapore 119967  
Tel: (65) 6835-3011/Fax: (65) 6835-2711

**OMRON (CHINA) CO., LTD.**

Room 2211, Bank of China Tower,  
200 Yin Cheng Zhong Road,  
PuDong New Area, Shanghai, 200120, China  
Tel: (86) 21-5037-2222/Fax: (86) 21-5037-2200

**Authorized Distributor:**

© OMRON Corporation 2016 All Rights Reserved.  
In the interest of product improvement,  
specifications are subject to change without notice.

**Cat. No. P662-E1-01**

0716-(-)