

Couplings type CPS

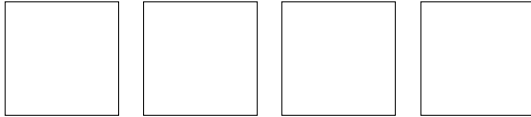

- Large compensation of misalignment
- Slight radial restoring forces
- No change of angular velocity in case of shaft displacement
- Damps vibrations
- Easy installation with clamping element
- Electrical insulating

Description

The CONTROLFLEX-coupling serves to couple two shafts whose axes don't exactly ly in a straight line. The middle plate of this coupling allows a relative loose parallel shaft displacement due to the special elasticity of the coupling elements without changing the angular velocity. In addition, form and material allow the compensation of angular mistakes (= dip of the axes to one another) up to 1,5°.

In practice and with good rotating stiffness, the elasticity of the used material and the length of the coupling elements give rise to negligible restoring forces. For higher torques and improved rotating stiffness please choose multi-plate versions, for example **CPS15/2**.

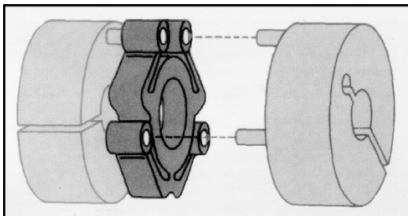

The CONTROLFLEX-coupling is made of two hard-coated aluminium clamping hubs into which are pressed two drive pins. These drive pins reach into the CONTROLFLEX – spring element without clearance, make possible an easy mounting and ensure accurately and reliably that the shafts are coupled. By using different sizes and varying the number of middle plates, the coupling can be adapted exactly to your demands.

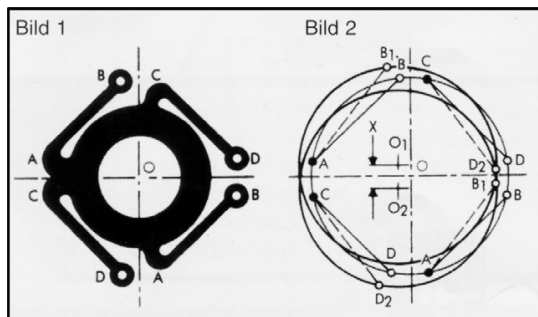

The geometry is made clear in picture 1. The shafts which have to be coupled align. In picture 2, one shaft is staggered $x/2$ towards the other. Around the same measure have been displaced B_1 from B and D_2 from D , while the driving arms AB and CD have remained parallel.

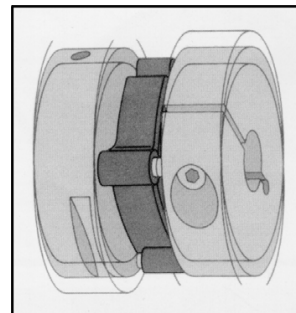

It follows that no angular displacement has happened (straight line). This parallel deflection is repeated twice during each rotation.

Mechanical Data

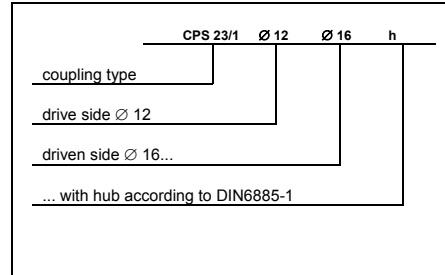
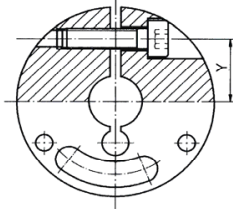
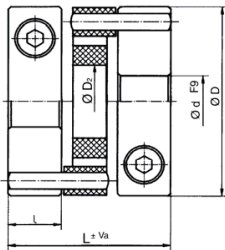

CPS	Characteristic data						Dimensions in mm										weight m (g)	inertia J (g cm ²)
	torque M (Nm)		max. power (kw)	max. displacement			geometry					clamping screw						
	max.	duration	standard value	radial Vr (mm)	axial Va (mm)	angle Vw (°)	outside -Ø D ⁽¹⁾	nominal length L	boring-Ø d max.	plate breadth l	element boring Ø D ₂ ⁽¹⁾	size	length	distance y	starting torque M (Nm)			
8/1	0.7	0.3	0.03	0.4	0.3	1.5	19	16.3	10	5.6	7	UNC 2	6	6.4	0.4	8	8	
8/2	1.4	0.6	0.05	0.4	0.3	1	19	20.3	10	5.6	7	UNC 2				9	9	
9	1	0.7	0.05	0.5	0.3	1	25	19	12.7	7.0	10.2	M 2.5	12	8	0.7	20	20	
9/1	1	0.7	0.05			1.5		20.5										
9/2	2	1.4	0.1			1.0		26										
10/1	1	0.7	0.05	1	0.3	1.5	25	25.5	12	9.5	10.2	M 3	12	7.7	1.3	25	20	
10/2	2	1.4	0.1			1		31								30	30	
14	3	2	0.1	1	0.3	1	37	21	7.0	14	M 3	12	14	1.3	50	100		
14/1	3	2	0.1			0.5		1.5									24	22
14/2	6	4	0.2			0.5		1									32	
15/1	3	2	0.1	1	0.5	1.5	37	30	20	10	14	M 4	16	12.4	3	60	110	
15/2	6	4	0.2			1		38								70	120	
22	10	7	0.5	1.5	0.5	1	56	35	34	12	18	M 5	20	21	5.7	180	800	
22/1	10	7	0.5			0.7		1.5								39	180	800
22/2	18	14	1			0.7		1								51	200	900
23/1	10	7	0.5	1.5	0.7	1.5	56	44.5	30	15	18	M 6	25	19.3	8	220	920	
23/2	18	14	1			1		57								240	1020	
30	22	15	0.75	2	0.5	1	75	50.5	40	18	28.5	M 8	30	25	24	500	3800	
30/1	22	15	0.75			1		1.5								57	500	3800
30/2	44	30	1.5			1		1								73	500	3800

¹⁾ if shaft has $d \leq D_2 - 2x$, radial displacement must be taken into account.

Type	Boring-Ø	Article-No.	CPS 10/2	10 / 10	34-000-044	CPS 15/2	6 / 10	34-000-058	CPS 15/2	12 / 14	34-000-096
CPS 8/1	6 / 5	34-000-090	CPS 10/2	10 / 12	34-000-026	CPS 15/2	8 / 10	34-000-084	CPS 15/2	14N/14N	34-000-070
CPS 8/1	6 / 6	34-000-053	CPS 10/2	12 / 12	34-000-027	CPS 15/2	10 / 10	34-000-022	CPS 15/2	15 / 6	34-000-102
CPS 8/1	6 / 10	34-000-054	CPS 10/2	12N/12N	34-000-034	CPS 15/2	10 / 11	34-000-081	CPS 22/2	10 / 20	34-000-043
CPS 8/1	10 / 8	34-000-104	CPS 14/2	10 / 10	34-000-068	CPS 15/2	10 / 12	34-000-064	CPS 23/1	12 / 28	34-000-099
CPS 9/1	5 / 10	34-000-087	CPS 15/1	6 / 10	34-000-031	CPS 15/2	10N/12N	34-000-063	CPS 23/2	10 / 15	34-000-076
CPS 9/1	6 / 6	34-000-100	CPS 15/1	10 / 10	34-000-050	CPS 15/2	10 / 14	34-000-057	CPS 23/2	10N/25N	34-000-079
CPS 9/1	6 / 10	34-000-038	CPS 15/1	10 / 12	34-000-061	CPS 15/2	10N/15N	34-000-069	CPS 23/2	20 / 20	34-000-032
CPS 9/1	8 / 10	34-000-035	CPS 15/1	10 / 20	34-000-021	CPS 15/2	10 / 16	34-000-078	CPS 30/1	12 / 14	34-000-080
CPS 9/1	10 / 10	34-000-025	CPS 15/1	12 / 12	34-000-062	CPS 15/2	10 / 20	34-000-039			
CPS 10/1	10 / 10	34-000-075	CPS 15/1	12 / 20	34-000-029	CPS 15/2	10N/20N	34-000-088			
CPS 10/2	6 / 6	34-000-055	CPS 15/2	4 / 6	34-000-059	CPS 15/2	12 / 6	34-000-045			
CPS 10/2	6 / 10	34-000-072	CPS 15/2	6 / 6	34-000-091	CPS 15/2	12 / 12	34-000-047			
CPS 10/2	8 / 10	34-000-048	CPS 15/2	6 / 8	34-000-060	CPS 15/2	12N/12N	34-000-086			

Further types on inquiry.